

# Transmission Expansion for Renewable Energy Scale-Up Emerging Lessons and Recommendations

**Marcelino Madrigal**  
**Steven Stoff**



THE WORLD BANK  
GROUP



The Energy and  
Mining Sector Board



## **AUTHORS**

*Marcelino Madrigal is a senior energy specialist in the World Bank's Energy Anchor Unit of the Sustainable Energy Department (SEGEN). He has previously held positions at the Inter-American Development Bank and the Ministry of Energy, Energy Regulatory Commission, and Morelia Institute of Technology in Mexico. He holds a B.Sc, M.Sc, and Ph.D in Electrical Engineering with emphasis in Power Systems and Markets' Operations and Planning.*

*Steven Stoft is the author of Power System Economics. He has consulted for PJM Interconnection and ISO New England and is now a member of the Market Surveillance Committee of the California ISO. He holds a Ph.D. in economics and a B.S. in engineering from the University of California at Berkeley.*

## **DISCLAIMERS**

*The findings, interpretations, and conclusions expressed in this paper are entirely those of the authors and should not be attributed in any manner to the World Bank, to its affiliated organizations, or to members of its Board of Executive Directors or the countries they represent. The World Bank does not guarantee the accuracy of the data included in this publication and accepts no responsibility whatsoever for any consequence of their use.*

## **CONTACT INFORMATION**

*To order additional copies of this discussion paper, please contact the Energy Help Desk: 202-473-0652, [energyhelpdesk@worldbank.org](mailto:energyhelpdesk@worldbank.org)*

*This paper is available online: [www.worldbank.org/energy/](http://www.worldbank.org/energy/)*

---

*The material in this work is copyrighted. No part of this work may be reproduced or transmitted in any form or by any means, electronic or mechanical, including photocopying, recording, or inclusion in any information storage and retrieval system, without the prior written permission of the World Bank. The World Bank encourages dissemination of its work and will normally grant permission promptly. For permission to photocopy or reprint, please send a request with complete information to the Copyright Clearance Center, Inc, 222 Rosewood Drive, Danvers, MA 01923, USA, fax 978-750-4470. All other queries on rights and licenses, including subsidiary rights, should be addressed to the Office of the Publisher, World Bank, 1818 H Street N.W., Washington, D.C., 20433, fax 202-522-2422, e-mail: [pubrights@worldbank.org](mailto:pubrights@worldbank.org).*

*Copyright © 2011. The World Bank Group. All rights reserved.  
Design and layout: The Word Express, Inc.*

# Transmission Expansion for Renewable Energy Scale-Up Emerging Lessons and Recommendations

**Marcelino Madrigal**  
**Steven Stoft**

**The World Bank, Washington, DC**



THE WORLD BANK  
GROUP



The Energy and  
Mining Sector Board

©2011 The International Bank for Reconstruction and Development / The World Bank

1818 H Street NW  
Washington DC 20433  
Telephone: (202) 473-1000  
Internet: [www.worldbank.org](http://www.worldbank.org)  
E-mail: [feedback@worldbank.org](mailto:feedback@worldbank.org)

### All rights reserved

This volume is a product of the staff of the International Bank for Reconstruction and Development / The World Bank. The findings, interpretations, and conclusions expressed in this volume do not necessarily reflect the views of the Executive Directors of the World Bank or the governments they represent. The World Bank does not guarantee the accuracy of the data included in this work. The boundaries, colors, denominations, and other information shown on any map in this work do not imply any judgment on the part of the World Bank concerning the legal status of any territory or the endorsement or acceptance of such boundaries.

### Rights and Permissions

The material in this publication is copyrighted. Copying and/or transmitting portions or all of this work without permission may be a violation of applicable law. The International Bank for Reconstruction and Development / The World Bank encourages dissemination of its work and will normally grant permission to reproduce portions of the work promptly. For permission to photocopy or reprint any part of this work, please send a request with complete information to the Copyright Clearance Center Inc., 222 Rosewood Drive, Danvers, MA 01923, USA; telephone: (978) 750-8400; fax: (978) 750-4470; Internet: [www.copyright.com](http://www.copyright.com).

All other queries on rights and licenses, including subsidiary rights, should be addressed to the Office of the Publisher, The World Bank, 1818 H Street NW, Washington, DC 20433, USA; fax: (202) 522-2422; e-mail: [pubrights@worldbank.org](mailto:pubrights@worldbank.org).

The World Bank Country Office Reports disseminate the findings of work in progress to encourage the exchange of ideas about development issues, especially in national languages.

## CONTENTS

<b>ACRONYMS AND ABBREVIATIONS</b> .....	viii
<b>FOREWORD</b> .....	ix
<b>ACKNOWLEDGMENTS</b> .....	x
<b>EXECUTIVE SUMMARY</b> .....	xi
<b>PART I: THE NEED TO ADDRESS TRANSMISSION ISSUES WHEN SCALING UP RENEWABLE: EMERGING PLANNING AND PRICING PRACTICES</b> .....	1
<b>1. INTRODUCTION</b> .....	3
1.1. Background.....	3
1.1.1. The Barriers to Renewable Energy.....	4
1.1.2. Why Developing Transmission is a Challenge to Scaling up Renewable Energy.....	5
1.1.3. Other Challenges Associated with Transmission Not Covered in This Report.....	6
1.2. The Need for Scaling up Transmission When Scaling up Renewable Energy.....	7
1.2.1. Findings from Long-Term Needs Assessments in Developed Countries.....	7
1.2.2. Findings from Immediate Investment Assessments from Developing Countries.....	9
<b>2. TRANSMISSION COST ALLOCATION AND PRICING</b> .....	13
2.1. Classification of Transmission Needs Triggered by Generation.....	13
2.2. Interconnection Cost Allocation.....	14
2.2.1. Overview of Interconnection Cost Allocation Policies and Practices.....	14
2.3. Network Infrastructure Pricing.....	16
2.3.1. Overview Network Infrastructure Pricing Methodologies.....	17
2.3.2. An Example of the Impact of Transmission Cost Allocation and Pricing.....	18
<b>3. PROACTIVE PLANNING AND OTHER INSTITUTIONAL ARRANGEMENTS TO EXPAND TRANSMISSION FOR RENEWABLE ENERGY</b> .....	21
3.1. Summary.....	21
3.2. Proactive Planning Practices and New Institutional Arrangements.....	21
3.2.1. Brazil.....	22
3.2.2. The Philippines.....	24
3.2.3. Mexico.....	26
3.2.4. The United Kingdom.....	29
3.2.5. Texas.....	31
3.2.6. Midwest ISO.....	35
3.2. New Technical Planning Options.....	42
3.3.1. Basics of Transmission Planning.....	42
3.3.2. Overall Principles and Methodology of Traditional Transmission Planning.....	43
3.3.3. Overview of Tools to Assist Traditional Transmission Planning.....	45
3.3.4. New Useful Modeling Approaches for Transmission Planning with Renewable Energy.....	46
3.3.5. Risk or Trade-Off Scenario Planning.....	46
3.3.6. Long-Term GIS-Enabled Generation and Transmission Planning with Hourly or Sub-Hourly Resolution.....	46
3.3.7. Methods for Developing Renewable Energy Zones for Planning Studies.....	48
3.3.8. Open and Participative Stakeholder Process to Improve Planning Outcomes and Broad Stakeholder Process.....	50
3.4. Combined Impact of Transmission Planning and Pricing on Renewable Energy Development.....	50

**PART II: RENEWABLE TRANSMISSION DEVELOPMENT: ECONOMIC PRINCIPLES ..... 53**

**4. TRANSMISSION AND RENEWABLE ENERGY, THE BASIC TRADE-OFF ..... 55**

4.1. Different Types of Entities that Provide Transmission Service ..... 55

4.2. Primary Objectives: The Reduction of Fossil Fuel Externalities ..... 56

4.3. Interactions Between Renewable-Policy and Transmission Efficiency ..... 57

4.3.1. A Pigouvian Tax as a Benchmark “Subsidy” Policy ..... 57

4.3.2. The Effects of Different Renewable Subsidies on Transmission Planning ..... 58

4.3.3. Production Subsidies ..... 59

4.3.4. Uniform Feed-in Tariffs ..... 59

4.3.5. The Standard Feed-in Tariff ..... 60

4.3.6. The Renewable Portfolio Standard ..... 61

4.4. The Generation-Transmission Basic Trade-Off ..... 61

4.4.1. Viewing Transmission as a Renewable Power Source ..... 62

4.4.2. Finding the Cost of Renewable Power Produced by a Transmission Line ..... 62

4.4.3. Using the Value,  $V$ , of Renewable Energy to Solve the Generation-Transmission Trade-Off ..... 64

4.4.4. Obtaining an Estimate of the Value,  $V$ , of Renewable Energy ..... 65

**5. ECONOMIC PRINCIPLES ON TRANSMISSION PLANNING ..... 67**

5.1. The Cost-Effectiveness of Extra Transmission ..... 67

5.1.1. Defining the Benefit of a Better Renewable Sources ..... 67

5.2. Developing Transmission Proactively ..... 68

5.2.1. Reactive Transmission Investment ..... 69

5.2.2. Anticipatory Transmission Investment ..... 69

5.2.3. Proactive Transmission Planning ..... 70

5.3. Maximize the Net Benefit of Renewable Transmission ..... 71

5.3.1. The Need Planning and for Pricing of Transmission ..... 72

5.3.2. A Transmission Planning Example ..... 72

5.3.3. Note on Planning for Uncertainty ..... 76

5.3.4. Achieving Quantity Goals and Price Targets ..... 76

5.4. A Note on Variable Output, Congestion, Reliability, and Cost ..... 77

**6. ECONOMIC PRINCIPLES OF TRANSMISSION PRICING ..... 79**

6.1. Observations on Traditional Principles of Transmission Cost Allocation and Pricing ..... 79

6.1.1. Charging Generation vs. Charging Load ..... 79

6.1.2. Charging on a per-Megawatt or per-Megawatt-Hour Basis ..... 79

6.1.3. Flow-Based Methods vs. Postage Stamp Methods in the Context of Renewable Energy ..... 80

6.2. Transmission Tariffs Mimicking Competitive Pricing ..... 80

6.2.1. Fairness to Electricity Consumers ..... 81

6.2.2. Increasing the Efficiency of Renewable Generation Investment ..... 81

6.2.3. Why Expansion-Pricing is Approximately Long-Term Congestion Pricing ..... 83

6.2.4. Why Expansion-Pricing is Better than Congestion Pricing ..... 84

6.2.5. Charging Full Price for Private Lines ..... 84

6.3. Broadly Allocating Uncovered Transmission Costs ..... 85

6.4. Summary of a Framework for Proactive Provision of Renewable Transmission ..... 86

**APPENDIX A: INVESTMENT ASSESSMENT BY JURISDICTION ..... 87**

United States ..... 87

Midwest ISO ..... 87

Texas—Competitive Renewable Energy Zones ..... 88

United Kingdom ..... 88

European Union ..... 92

Mexico ..... 94

Panama ..... 96

Egypt ..... 97

Brazil ..... 100

The Philippines ..... 101

<b>APPENDIX B: REVIEW OF CONNECTION COST ALLOCATION AND NETWORK INFRASTRUCTURE PRICING METHODOLOGIES</b> .....	105
<b>B.1 Cost Allocation</b> .....	105
Spain .....	105
Germany .....	105
Denmark.....	105
United Kingdom .....	105
Texas.....	105
Mexico .....	106
Panama .....	106
Brazil .....	106
The Philippines .....	106
Egypt .....	107
<b>B.2 Review of Network Infrastructure Pricing Methodologies</b> .....	107
Spain .....	108
Germany .....	108
Denmark.....	108
United Kingdom .....	108
Texas.....	108
Mexico .....	109
Panama .....	109
The Philippines .....	109
Brazil .....	109
Egypt .....	109
<b>APPENDIX C: TOPICS ON TRANSMISSION PLANNING: RELIABILITY CRITERIA AND NEW TOOLS</b> .....	111
<b>BIBLIOGRAPHY</b> .....	117

**BOXES**

<b>Box 3.1:</b> The Overall Transmission Planning Process.....	45
<b>Box 3.2:</b> Some GIS-Enabled Transmission Expansion Models with Emphasis on Renewable Generation .....	48
<b>Box 3.3:</b> Site Selection Methodology Midwest ISO Transmission Planning Study.....	51
<b>Box 4.1:</b> Transmission Cost and Choice of Greenhouse Gas Mitigation Options .....	56
<b>Box 4.2:</b> Subsidies and Transmission Planning .....	59
<b>Box 4.3:</b> An Important Note on Measuring the Cost of Transmission .....	62
<b>Box 5.1:</b> Example of the Basic Trade-Off: Why Building More Transmission Can Easily Save Money .....	68
<b>Box 6.1:</b> Summary Principles on Transmission Expansion and Pricing for Renewable Energy .....	86
<b>Box C.1:</b> PRS-Netplan Model for Designing Shared Networks for Multiple Projects in Renewable Zones .....	116

**FIGURES**

<b>Figure 1.1:</b> Increase in Global Renewable Energy Generation and Wind and Solar PV Installed Capacity, 2000–08.....	3
<b>Figure 2.1:</b> Transmission Classification .....	13
<b>Figure 2.2:</b> Allocation and Pricing of Transmission Costs.....	18
<b>Figure 2.3:</b> Transmission Infrastructure—Connecting a Wind Farm to an Existing Transmission Network .....	19
<b>Figure 2.4:</b> LCOE Scenarios .....	20
<b>Figure 3.1:</b> Location of Bagasse Cogeneration and SH Plants (left), Renewable Candidate Projects in Mato Grosso do Sul (right).....	22
<b>Figure 3.2:</b> Brazil’s Competitive Process to Develop Shared Transmission Networks for Renewable .....	23
<b>Figure 3.3:</b> Reactive vs. Anticipatory Transmission Plan to Connect Renewable Energy Sites .....	26
<b>Figure 3.4:</b> Wind Power Capacity in Operation in La Ventosa Region .....	27
<b>Figure 3.5:</b> Transmission Planning Open Season Process—Mexico .....	28
<b>Figure 3.6:</b> Transmission Infrastructure to Connect RE as Result of the Open Season.....	29
<b>Figure 3.7:</b> CREZ Process, Texas.....	33



<b>Figure 3.8:</b>	Potential Wind Resources, Texas.....	35
<b>Figure 3.9:</b>	Texas CREZ Map .....	36
<b>Figure 3.10:</b>	Balancing Authority Alignment.....	37
<b>Figure 3.11:</b>	RPS and Renewable Goals for Individual States.....	38
<b>Figure 3.12:</b>	RPS or Renewable Goals for Respective States within Midwest ISO .....	38
<b>Figure 3.13:</b>	Total Generation and Transmission Cost for Each Option, Midwest ISO.....	39
<b>Figure 3.14:</b>	Transmission Cost Based on Three Expansion Scenarios, Midwest ISO (US\$ millions) .....	39
<b>Figure 3.15:</b>	The Value-Based Planning Approach Used by Midwest ISO .....	40
<b>Figure 3.16:</b>	Midwest ISO Transmission Planning Process.....	42
<b>Figure 3.17:</b>	Cost and Reliability Trade-Off .....	43
<b>Figure 3.18:</b>	Building Blocks of a Basic Transmission Planning Methodology .....	44
<b>Figure 3.19:</b>	Impact of Transmission Planning and Cost Allocation on Renewable Energy Penetration .....	52
<b>Figure 5.1:</b>	Anticipatory Transmission Planning.....	69
<b>Figure 5.2:</b>	Comparing Three Transmission Plans .....	73
<b>Figure 6.1:</b>	Why Charge for Some Transmission? .....	82
<b>Figure A.1:</b>	Connecting Wind Farm to Existing Transmission Network.....	87
<b>Figure A.2:</b>	Native Voltage Transmission Overlay.....	88
<b>Figure A.3:</b>	Transmission Investments, 2007–15 (i), and Cumulative Installed Capacity (MW), 2007–14 (ii).....	89
<b>Figure A.4:</b>	Competitive Renewable Energy Zones (CREZs) .....	90
<b>Figure A.5:</b>	Renewable Electricity Generation in the United Kingdom .....	92
<b>Figure A.6:</b>	Renewable Energy Share Targets of the European Countries .....	93
<b>Figure A.7:</b>	New Installed Capacity per Year, 1995–2010 (MW) .....	93
<b>Figure A.8:</b>	Grid Model Mapping Used by Energynautics Grid Study, Status 2010 .....	94
<b>Figure A.9:</b>	Wind Speeds in La Ventosa Region Located in the Southeastern State of Oaxaca.....	95
<b>Figure A.10:</b>	Existing Transmission Network and New Transmission Needs in La Ventosa Region.....	96
<b>Figure A.11:</b>	Mini-Hydro Sites and Existing and Proposed Substations. Panama Chiriquí Region .....	97
<b>Figure A.12:</b>	BOO Transmission Project in Egypt.....	99
<b>Figure A.13:</b>	Transmission Infrastructure for Renewable Project in Egypt .....	100
<b>Figure A.14:</b>	Some of the Renewable Candidate Projects in Mato Grosso do Sul.....	101
<b>Figure A.15:</b>	Philippine Bulk Transmission System and Map Showing All Renewable Candidate Projects and All Transmission System Substations in Luzon .....	102
<b>Figure C.1:</b>	Transmission Planning in Colombia: Methodology Building Blocks .....	113
<b>Figure C.2:</b>	High-Level Planning Process Flow Diagram.....	114

## TABLES

<b>Table 1.1:</b>	Summary of Long-Term Investment Needs Assessments for the European Union, United Kingdom, and United States.....	9
<b>Table 1.2:</b>	Immediate Investment Needs—Brazil, Egypt, Mexico, Panama, and the Philippines .....	11
<b>Table 2.1:</b>	Connection Cost Allocation Policy .....	15
<b>Table 2.2:</b>	Connection Cost Allocation Policy .....	16
<b>Table 2.3:</b>	Connection Cost and UoS Pricing Summary by Country/Region.....	19
<b>Table 2.4:</b>	Transmission and Usage Cost Options.....	20
<b>Table 3.1:</b>	Summary of Results—NPV of Total Costs and IRR.....	25
<b>Table 3.2:</b>	Round One Projects—U.K. Transitional Procurement.....	30
<b>Table 3.3:</b>	Round Two Projects—U.K. Transitional Procurement.....	30
<b>Table 3.4:</b>	Texas Transmission Expansion Projections .....	32
<b>Table 3.5:</b>	Megawatt Tiers for ERCOT CREZ Transmission Optimization Study.....	36
<b>Table 3.6:</b>	Risk-Based and Scenario Planning Approaches in Transmission and Renewable Energy Planning .....	47
<b>Table 4.1:</b>	Cost and Value of Solar PV-Generated Energy.....	64
<b>Table 4.2:</b>	Estimating the Value of Renewable Energy.....	66
<b>Table 5.1:</b>	Transmission to Remote Location 1 ( $Q_{R1} = Q$ ).....	74
<b>Table 5.2:</b>	Plan 2: Transmission to Remote Location 2.....	75
<b>Table 5.3:</b>	Three-Plan Example, $Q = 200$ MW .....	76
<b>Table 6.1:</b>	Auctioning Access to the Line in Figure 6.1, with a FIT Price of US\$150 .....	82
<b>Table A.1:</b>	Summary of Estimated Costs for Transmission Facilities.....	88
<b>Table A.2:</b>	Estimated Investment Needs from the CREZ Study .....	91
<b>Table A.3:</b>	Approved Capital Expenditures for the Three U.K. Transmission Companies.....	92



<b>Table A.4:</b> Installed Capacity in Egypt as of 2009.....	98
<b>Table A.5:</b> Wind and Solar Expansion Plan (MW).....	98
<b>Table A.6:</b> Potential Renewable Generation Capacity per Grid (MW) .....	101
<b>Table A.7:</b> Total Capital Expenditure Approved for the Transmission Company, 2005–10.....	103
<b>Table B.1:</b> Basic Formulas for Various UoS Charge Methodologies.....	107
<b>Table B.2:</b> Flat-Rate UoS, Mexico.....	109
<b>Table C.1:</b> Various Models That Assist with Transmission Planning.....	111
<b>Table C.2:</b> Some Widely Used Reliability Criteria.....	115

## ACRONYMS AND ABBREVIATIONS

AC	Alternating current	ISO	Independent system operator
ANEEL	<i>Agência Nacional de Energia Elétrica</i>	km	Kilometer
APC	Adjusted Production Cost	kV	Kilovolt
BBS	Best break-even site	LCOE	Levelized cost of electricity
BOO	Build, own, operate	MVA	Megavolt-ampere
CCGT	Combined cycle gas turbine	MVP	Multi-Value Projects
CCN	Certificate of convenience and necessity	MW	Megawatt
CCS	Carbon capture and storage	MWh	Megawatt-hour
CFE	Comisión Federal de Electricidad (Mexico)	NBT	Net benefit
CO <sub>2</sub>	Carbon dioxide	NERC	North American Electric Reliability Corporation
CPDST	Competitive Process to Develop Shared Transmission Networks	NGET	National Grid Electricity Transmission
CRE	Energy Regulatory Commission (Mexico) <i>Comisión Reguladora de Energía</i>	NPV	Net present value
CREZ	Competitive renewable energy zone	NREA	New and Renewable Energy Authority
CSP	Concentrated Solar Power	NREB	National Renewable Energy Board
DC	Direct current	NREL	National Renewable Energy Laboratory
DOE	Department of Energy	OFGEM	Office of the Gas and Electricity Markets
DSO	Distribution system operator	OFTO	Offshore transmission owner
EETC	Egyptian Electricity Transmission Company	PAC	Planning Advisory Committee
EIA	Energy Information Administration (U.S.)	PPA	Power purchase agreement
EPE	Empresa de Pesquisa Energética (Brazil)	PRM	Planning reserve margin
ERC	Energy Regulatory Commission (Philippines)	PUC	Public Utility Commission of Texas
ERCOT	Electric Reliability Council of Texas	PV	Photovoltaic(s)
ESMAP	Energy Sector Management Assistance Program	RGOS	Regional Generation Outlet Study
FERC	Federal Energy Regulatory Commission	RIIO	Revenue = incentives + innovation + outputs (a model)
FIT	Feed-in tariff	RO	Renewable obligation
GHG	Greenhouse gas	RPS	Renewable Portfolio Standard
GIQ	Generation Interconnection Queue	RTO	Regional transmission organization
GIS	Geographic information system	SH	Small hydropower
GW	Gigawatt	SHETL	Scottish Hydro-Electric Transmission Limited
GWh	Gigawatt-hour	SPT	Scottish Power Transmission Limited
HVDC	High-voltage direct current	TSC	Transmission service company
IEA	International Energy Agency	TSO	Transmission system operator
IRR	Internal rate of return	TWh	Terawatt-hour
		UoS	Use of system
		WinDS	Wind Development System (NREL, United States)

## FOREWORD

In their efforts to move toward a lower-carbon power sector, developed and developing countries are facing the need to considerably expand their transmission networks to serve the needs of renewable energy. The most cost effective renewable energy resources needed to decarbonize the electricity supply are usually located far from the existing transmission networks and consumption centers. Thus, transmission networks need be expanded and upgraded in order to reliably and cost-effectively connect and transport renewable energy supplies. Policy makers need be aware that renewable energy scale-up goes hand in hand with the expansion of transmission networks and that proper planning and regulatory actions are therefore necessary.

This report reviews emerging approaches being undertaken by transmission utilities and regulators to cope with the challenge of expanding transmission for renewable energy scale-up. The challenge becomes surmountable if the conducive planning and regulatory approaches are implemented. Proactively planning and regulating transmission networks have been identified as key to ensure that transmission networks are expanded efficiently and effectively. Linking planning with clear and stable cost recovery regulations can also help bringing the private sector to complement the considerable investment needs in transmission.

Based on the evolving experience and on established theory and practice, the report also proposes some principles to develop country-specific approaches to planning and regulation of transmission networks. We hope transmission utilities and regulators will find this report useful in their continued efforts to support a transition to lower-carbon power networks.

### ***Lucio Monari***

Manager, Energy Anchor Unit (SEGEN)  
Sustainable Energy Department

## ACKNOWLEDGMENTS

The report is a result of a team of World Bank staff and consultants led by Marcelino Madrigal (Senior Energy Specialist) of the Sustainable Energy Department Energy Anchor unit (SEGEN). The main authors of the report are Marcelino Madrigal and Steven Stoff (consultant). Other important contributors to the report are Imran Ali (consultant), Jay JangHo Park (consultant), Ashaya Basnyat, and Jens Wirth (SEGEN), and Digaunto Chatterjee (Midwest ISO). The report benefited as well from an inception paper commissioned by the World Bank to E3 Energy Environment Economic Inc.'s consultant Ren Orans. Thanks also to Vonica Ann Burroughs and Katerina Baxevanis (SEGEN) who provided operational support to this project. Rebecca Kary provided editorial support.

The final report greatly benefited from the insightful comments and suggestions of World Bank peer reviewers Beatriz Arizu de Jablonski, Kwawu Mensan Gaba, and Reynold Duncan. Special thanks to other World Bank staff who provided important revisions and suggestions, including Pierre Audinet, Victor B. Loksha, and Silvia Martinez Romero of the Energy Sector Management Assistance Program (ESMAP), and Daniel Kammen and Gabriela Elizondo Azuela of the World Bank. This research benefited greatly from knowledge dissemination events organized by the World Bank over the past two years. Special thanks to Digaunto Chatterjee (Midwest ISO), Kevin Porter (Exeter Associates, Inc. USA), Jose Carlos de Miranda Farias (Energy Planning Agency, Brazil), Francisco Barnes de Castro (Energy Regulatory Commission, Mexico), and Luiz Augusto Barroso (PSR-Inc., Brazil).

We are grateful to Lucio Monari, sector manager of SEGEN, who provided valuable inputs to the report and was responsible for the overall guidance and supervision of this knowledge product.

Financial support for the research and production of this report was provided by ESMAP.

## EXECUTIVE SUMMARY

**Scaling up renewable energy, such as wind and solar, goes hand in hand with the expansion of transmission infrastructure.** The richest solar and wind renewable energy sites are often located far away from consumption centers or existing transmission networks. Unlike fossil fuel-based power sources, renewable energy sources are greatly site-constrained and, for this reason, transmission networks need to be expanded to reach the renewable energy sites. Delivering transmission is a challenge, given the dispersion and granularity of renewable sources. Tapping a few hundred megawatts of renewable energy sources, such as wind and solar power, will likely require delivering transmission to several sites. Furthermore, transmission is also required to smooth out the variability of new renewable sources in a large geographical area. For these reasons, countries' renewable energy scale-up efforts are being challenged by the need for timely and efficient delivery of transmission networks.

**Investment needs for transmission expansion to accommodate renewable energy are significant and growing in both developed and developing countries, and they are challenging existing planning and cost-recovery practices.** Although the cost of transmission continues to be a relatively small percentage of overall electricity costs, the investments in transmission required to scale up renewable energy are rapidly growing. In some subregions in the United States and countries in Europe, the transmission investment needs already approved by regulators or forecast by transmission companies double or quadruple recent investment trends. Developing countries face a similar situation. Incipient renewable energy scale-up efforts are being challenged by the need to expand transmission to remote sites. Investment needs in Brazil, Egypt, Mexico, and other countries have triggered new approaches to plan and recoup the cost of transmission associated with renewable energy. For instance, in some specific regions in Brazil, the investment needs for renewable energy surpass the asset value of the distribution utilities closest to the renewable energy sites, which has triggered the establishment of a new model to award private transmission-owning concessions to serve renewable energy sites. In Mexico, the need to accommodate various wind power developments led to a new planning process to determine the cost-sharing of the transmission facilities between renewable energy

providers and the utility and to a revision of the network wheeling charges paid by renewable energy providers.

**The objective of this report is to present emerging lessons and recommendations on approaches to efficiently and effectively expand transmission networks for renewable energy scale-up. The report focuses on the planning and regulatory aspects of transmission expansion that are relevant to transmission utilities and electricity regulators.**

*Chapter 1* of the report describes the special features of renewable energy scale-up that make transmission development a new challenge from the technical and the regulatory perspective. The chapter describes in detail the above-mentioned increase in transmission investment needs in both developed and developing countries as a consequence of the need to integrate more renewable energy into their systems. The chapter describes long- and short-term assessments performed to determine transmission investment needs to achieve certain renewable energy targets or to serve the immediate needs of specific renewable energy projects, respectively. Efficiently and effectively developing transmission for renewable energy requires a new vision for the long-term planning and regulation of transmission services. For this reason, this report focuses on such aspects and does not deal with other short-term operational issues that arise in operating transmission systems with large amounts of renewable energy. While also important, environmental, social, and financing aspects of transmission are not within the scope of this report. The main audience of this report is utilities that provide transmission services and electricity regulatory commissions. At the same time, this summary highlights important messages for renewable energy policy makers.

**To circumvent the impact of the cost of transmission on renewable energy producers, electricity regulators are adjusting transmission cost-recovery practices. Existing regulations on transmission broadly categorize transmission costs associated with generation projects as connection and network costs.** Connection costs refer to the transmission investments that are required for the sole purpose of connecting an individual generator's premises to the transmission network. Network costs refer to all other investments necessary to reinforce the entire network, so that it can adequately and reliably transport all generation to the consumption center.

Connection cost and network cost, along with an appropriate maintenance and return on investment allowance, must be recouped through tariffs to ensure sustainability of transmission utilities. *Chapter 2* provides an overview of different alternatives to allocate connection and network costs, an international overview of practices, and the qualitative and quantitative impacts—through an example—on renewable energy of different cost allocation policies. Regarding connection costs, *Chapter 2* describes how policies vary from options that place the highest burden on the renewable energy provider to options that place little or no burden. In the first category is the deep cost allocation policy where renewable energy providers bear the cost of all enabler facilities (substations), the extension to the grid, and reinforcements that are necessary to integrate the project into the transmission network. In the second category is the shallow cost allocation policies whereby power generators are responsible only for the cost of the enabling facilities, and the cost of system extension and reinforcements is passed on to consumers through network prices. Although countries that have experienced more growth in renewable energy have adopted shallower cost allocation procedures, there is no clear evidence that generators should not bear any connection costs at all. Regarding network costs, there is a trend toward allocating most of these costs to consumers and using simpler methodologies that do not rely on engineering-based methodologies based on “use of system” estimations. Postage stamp-like methodologies are seen as effective and efficient enough to ensure that long-term network costs are efficiently recovered, which is the main obstacle to tackle in systems with high-demand growth for transmission services triggered by electricity demand or renewable energy growth.

**Although adjusting cost-recovery regulations can have positive short-term impacts, improving planning practices is a necessary condition for ensuring a sustained and cost-effective development of the required transmission investment needs.** Planning transmission for renewable energy based on responding to individual interconnection requests is not well suited for renewable energy scale-up for different reasons. First, transmission solutions to individually interconnect dispersed resources can lead to suboptimal, more expensive solutions. Second, an interconnection request planning-driven process will significantly “clog” transmission providers' processes and scarce

human resources, leading to delays in the process to scale up renewable energy. Implementing anticipatory planning practices is emerging as the best way to organize the planning process. Anticipatory planning will design transmission solutions for sets of projects in geographical areas, thereby reducing costs and improving the efficiency of the process. Anticipatory planning has been used in a number of jurisdictions, including Brazil, Mexico, the United Kingdom, and the United States, as described in the first two sections of *Chapter 3*. To ensure that the most cost-effective solution, combined transmission and generation cost, is exploited first to achieve renewable energy goals efficiently, proactive planning—a step forward to anticipatory planning—is required. This is the case of recent efforts in the Midwest ISO and Texas regions in the United States, where planning for transmission networks considers the trade-off between spending more in transmission and accessing higher-quality resource sites. While planning for transmission does not always affect decisions in generation, prioritizing transmission investments through planning is a way to influence outcomes that lead to the lowest overall generation and transmission costs. The first three sections of *Chapter 3* describe new institutional approaches for planning that have been implemented in a number of jurisdictions to expand transmission services for renewable energy.

**Anticipatory and proactive planning approaches accompanied by simple yet efficient cost-allocation rules are facilitating the implementation of new regulatory models to develop transmission with help from the private sector.** Organizing the transmission planning process is facilitating the development of new regulatory models to bring private sector participation to the transmission sector. This is especially important, given the increased investment needs triggered by renewable energy and the need to speed up and complement efforts by incumbent transmission utility or utilities. A public sector-led proactive planning effort followed by competition to finance, build, and maintain the requisite transmission projects is emerging in different countries. Presented in *Chapter 3*, Brazil, Texas, the Midwest ISO, and the United Kingdom are examples of such new approaches. In these countries, a proactive planning process identifies the transmission investments, and the cost-allocation rules are such that competing transmission providers have a regulated and assured return on the investment. In the case of Brazil, the

approach has been used to develop high-voltage transmission networks, but has now been extended to the subtransmission segment where investment needs to interconnect renewable energy have been considerable. In the case of Texas, the approach has been used to develop the transmission project associated with the renewable energy zones procedure. In the case of the Midwest ISO, a similar approach has been used to plan and cost-allocate the regional transmission needed to serve the needs of various states' renewable energy targets. Finally, in the case of the United Kingdom, the approach is being used to develop the rapidly growing transmission needs for offshore wind development.

**New planning methodologies and tools can greatly assist transitioning from reactive to anticipatory or proactive planning approaches to expand transmission.** No single tool has been able to solve all transmission planning problems, but new methodologies and tools have emerged, which are increasingly helping transmission utilities to implement proactive transmission planning processes in relation to renewable energy scale-up efforts. These tools are described in the last section of *Chapter 3*. Scenario and robust planning methodologies have been used before for generation and to some extent for transmission planning, and they are reemerging as a powerful tool in transmission planning for renewable energy. Long-term transmission planning is subject to a number of uncertainties, such as technology costs, choice of regulations, carbon prices, and development in the generation market—including renewable generation—outside the control of the transmission planner. To incorporate such uncertainties and understand the associated risk, scenario or robust planning methodologies are proving extremely useful when implementing proactive transmission planning for renewable energy. These methodologies are useful for understanding the long-term implications of policy choices, such as the cost implications of meeting renewable energy targets from local or regional renewable energy sources, and the cost and environmental implications of different transmission technologies, as well as to identify priority and sequencing of projects to achieve renewable energy goals. *Chapter 3* describes the application of scenario planning utilized in regional transmission planning efforts highlighting the case of the Midwest ISO. Scenario or robust planning methodologies do not necessarily require new planning tools; these

methodologies can be implemented with the existing tools for transmission planning.

Helping implement anticipatory planning to determine transmission expansion solutions to dispersed renewable energy sites can be assisted greatly by new tools that have the capability to automatically generate transmission expansion options that exploit the geometrical location of sites to define minimum-cost transmission options that can serve collectively—and not individually—all the sites. This approach has been implemented in Brazil’s biomass cogeneration, and its application has also been shown to be useful for analyzing alternatives in the Philippines. Such new tools are often able to process locational information on existing networks and potential renewable energy sites based on a geographic information system (GIS).

Tools that are used to plan transmission, while at the same time optimize the amount of renewable energy source that is tapped, are increasingly useful for proactive renewable energy planning. Such types of tools are increasingly useful to determine longer-term transmission investment needs to achieve certain renewable energy targets or to determine proxy solutions to the problem of minimizing renewable generation plus transmission costs. New tools in this arena are increasingly being developed and used in the United States to determine long-term transmission needs to achieve renewable energy targets at the national or regional levels. Tools to assist proactive planning require large amounts of data, especially on the projected output of renewable generation, such as solar and wind power output projects that ideally must be provided with an hourly resolution to capture the complementarities of different variable resources across the transmission network better. **Successfully applying new approaches and tools requires a certain level of technical capacity that may not be available to all utilities that provide transmission services and other entities involved in the planning process. For this reason, in some circumstances, it may be equally or more important to increase technical skills as new approaches and tools are adopted.**

**Maintaining overall efficiency of renewable energy support policies requires that transmission planners and regulators make trade-offs between the cost of transmission and, ideally, a value of renewable energy determined by policy makers.**

Based on the emerging experience in transmission development for renewable energy described above and on some of the established theory on transmission planning and pricing, the second part of this report focuses on proposed economic principles that should help guide designing the specific implementation of transmission expansion and pricing regulations for renewable energy. The guiding objective of these principles is that renewable energy policy goals should be achieved as efficiently and effectively as possible. *Efficiency* means achieving policy objectives—such as reducing emissions—at lowest cost, and *effectiveness* means attaining the final goals on time (such as a certain level of renewable generation penetration in a given year). *Chapter 4* describes how the cost of transmission could change the order of the lowest-cost generation options to achieve certain objectives, such as reducing emissions. It also describes the interactions between energy support mechanisms, such as feed-in tariffs and renewable portfolio standards mechanisms and transmission planning. We use the concept of a Pigouvian tax—a single price on carbon—as an efficient benchmark to determine how transmission planning should be approached in the presence of different subsidy levels for different technologies, which is a frequent situation in current renewable energy support policies. Making appropriate trade-offs between transmission and renewable generation cost should ideally be handled if a value of renewable energy is determined by policy makers. Options to determine the value of renewable energy include valuing externalities or other benefits of renewable energy briefly described in *Chapter 4*.

**Recognizing that policy goals, sector structures, existing regulations, and capabilities to implement new tools vary across countries, we offer some general principles to help guide the design of transmission planning and pricing regulations aiming at effectively and efficiently developing transmission for renewable energy.** The principles, presented in detail in *Chapter 5* and *Chapter 6*, are not policy proposals per se, nor do they provide a detailed roadmap for implementation. Taking specific country conditions and goals, these principles should help guide on designing specific implementations of transmission planning and regulation options aiming at ensuring renewable energy policy outcomes are as close as possible to the ideal efficient benchmark described in *Chapter 4*. The principles are summarized in the following box.



**Principle 1: Extra transmission is often worth the cost.** Renewable sources tend to require significant transmission expansion, because output—and cost—of these generators is particularly sensitive to their location. The required investment in transmission expansion is often worth the cost given that the incremental benefits of additional renewable generation frequently offset the incremental costs of transmission. This principle implies that transmission has been planned proactively, and the appropriate trade-offs and risks of Principles 2 and 3 below have been analyzed.

**Principle 2: Develop transmission proactively.** Expanding transmission can be approached in two opposite ways: reactive and proactive approaches. In the reactive approach, the transmission provider reacts to committed renewable energy projects, and in the proactive approach, the provider builds transmission with the intention of guiding the efficient growth of the power system. Under reactive transmission development, if renewable generation providers have limited cost responsibility, the decision process is likely to produce inefficient results and cause significant delays. Proactive planning is a better policy. Proactive planning does not mean perfect planning, but the outcome should be much more efficient than the reactive approach where the transmission needs are planned based on a large number of uncoordinated and self-interested generators. Proactive planning will result in more timely provision of transmission and building transmission to higher-quality resources, balancing the trade-off. An intermediate step is to perform anticipatory planning where transmission does not guide generation investment or intend to reach the best resources, but rather attempts to build lines in minimum cost areas where generators will be located.

**Principle 3: Maximize the net benefit of renewable transmission.** When transmission is built proactively, the transmission provider must strategize the network expansion; therefore, planning criteria guidance is needed. The first component of Principle 3 is to build transmission lines as if the planner had control over both the transmission and generation investment. This means maximizing the joint net benefit of transmission and generation. Even though the planner will not have direct control over generation, he can influence it through building and pricing transmission lines.

**Principle 4: Transmission tariffs for generation should use efficient pricing.** Building the right transmission is not sufficient; appropriate transmission pricing is also needed. First, it is needed to send the right locational signals to generators. Second, it is needed to capture some locational rents—excess profits—for consumers. When it comes to renewable energy, the locational signal intends to help achieve, through pricing, that the best combined transmission and renewable generation resources are developed. The suggested renewable generation transmission prices are not meant to and will not recover the full cost of transmission, so Principle 5 explains how to allocate the part of transmission costs not covered by transmission pricing.

**Principle 5: Broadly allocate uncovered transmission costs.** Transmission companies should recoup all efficient costs to ensure their sustainability. Any shortfall from allocation to generation should be compensated by a tariff that is fair and causes as little distortion to electricity generation and use as possible. Since the benefit of renewable energy does not come from the energy itself, but rather from the externalities it reduces, there is no rational way to charge those who use renewable energy for benefits that are not associated with it. Consequently, the additional transmission charges, beyond the pricing described in Principle 4, should be applied as broadly as possible.



**PART I**

**THE NEED TO ADDRESS TRANSMISSION ISSUES**

**WHEN SCALING UP RENEWABLE:**

**EMERGING PLANNING AND PRICING PRACTICES**



## 1. INTRODUCTION

The report is structured in two Parts. Part I focuses on describing why providing transmission services for renewable energy represents a new challenge, as well as reviewing some of the approaches different countries are using to face the challenge. Chapter 1 describes some of the investment needs identified in both developed and developing countries in the context of their scale-up efforts. Chapters 2 and 3 review emerging responses from governments and regulators with regard to transmission cost allocation and pricing and transmission planning for renewable energy. Planning aspects include institutional arrangements, methodological aspects, and tools.

Based on the emerging practices reviewed in Part I and with help from some of the established theory on transmission pricing and planning, Part II of the report focuses on analyzing the economic principles and providing recommendations on transmission expansion and pricing for renewable energy. Chapter 4 describes a basic trade-off between transmission and renewable generation that is used throughout the analysis in Part II. Chapter 4 also describes the economic interactions between renewables support policies and transmission policy. The concepts introduced in Chapter 4 are used to analyze the recommended principles to guide transmission expansion and pricing, which are described in Chapters 5 and 6, respectively. The principles are intended to help decision making on important issues that frequently arise in the context of delivering transmission services for renewable energy. These issues

include (a) which rules should be more adequate for the allocation of transmission cost to renewable energy; (b) which principles should be followed to understand the implications of transmission cost of achieving the policy goals being pursued with the introduction of renewable energy; and (c) how transmission expansion should be addressed to cost-effectively and efficiently help meet the goals of renewable energy policy.

### 1.1. Background

Renewable energy technologies, such as wind and solar power, are becoming an increasingly attractive complement to existing energy supplies, because of climate change and energy diversification concerns. From 2004 to 2009, global renewable energy capacity grew from 10 percent to 60 percent annually. In 2009, 38 GW of additional wind power capacity was added globally, a 41 percent increase from 2008, bringing global wind power to 159 GW. Additionally, solar photovoltaics (PV) continues to be the fastest-growing power generation technology in the world, adding 7 GW capacity to the grid and increasing the existing total by 53 percent to approximately 21 GW globally. As seen in Figure 1.1, wind and solar PV are the fastest-growing technologies, considering that the annual growth rates for hydropower, biomass power and heat, and geothermal power are at 3–6 percent (REN21 2010).

Clearly, governments increased their efforts to scale up renewable energy. By early 2010, more than 100 countries had developed policy targets or promotion policies, or both, related to renewable energy,

**Figure 1.1: Increase in Global Renewable Energy Generation and Wind and Solar PV Installed Capacity, 2000–08**

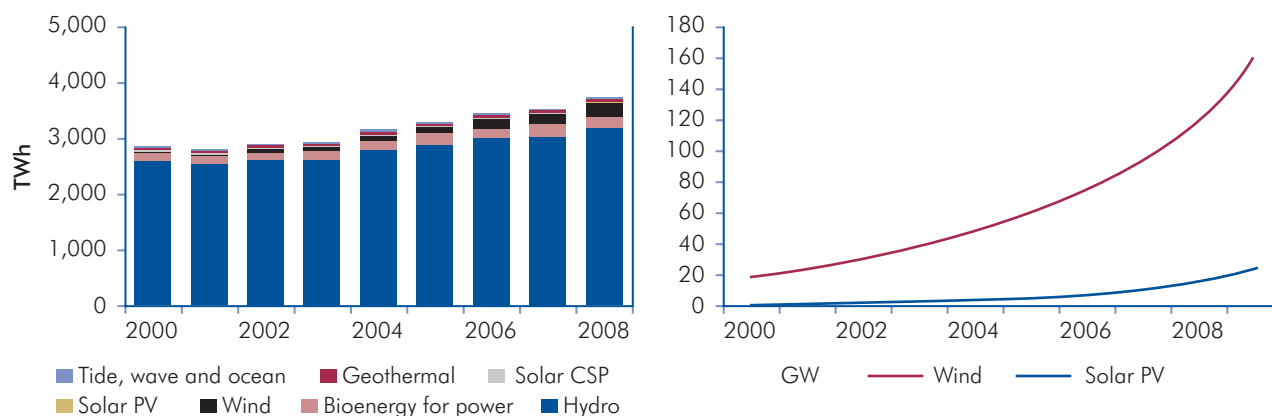

Source: IEA 2011 and the authors.

compared to 55 countries in early 2005 (REN21 2010). High and volatile oil prices, the need to diversify energy services, technology development and employment generation, and the need to decisively address the climate challenge are driving the deployment of renewable energy in developed and developing countries. While declining technology costs for wind and solar power have helped to increase their share in the global energy supply mix, the most considerable increases are linked to strong and decisive government support through various incentive mechanisms.

The objectives of increasing renewable energy technologies in developing countries include not only the reduction of emissions, but also diversifying energy supplies and reducing price volatility. Aiming at these objectives, several developing countries have established different renewable energy goals. For instance, China is pursuing integration of 20 GW of solar power generation by 2020. Meanwhile, Thailand aims to achieve a 20 percent share of power generation from renewable sources by 2022; Egypt aims for 20 percent of electricity consumption from renewables by 2020; Kenya is planning to install 4 GW of geothermal capacity by 2030; the Mexican congress approved the National Energy Strategy in 2010, which includes a targeted 35 percent share of renewable energy in power generation by 2024; and the Turkish government set its target to a 30 percent share of renewable energy generation of the total by 2023.

Achieving renewable energy goal requires introducing different policies and regulations to address the existing barrier of renewable energy. These barriers include, among others, the following: (a) addressing the higher-cost disadvantage of renewable energy by introducing subsidies to renewable energy, internalizing the negative impacts of fossil fuel options, or reducing their subsidies when possible; (b) creating a level playing field for renewable generation by reducing transaction costs related to land and resource concession processes; and (c) providing timely and efficient transmission services. These barriers, discussed in more detail in the subsequent section, are being addressed in different ways. While there is considerable theoretical and practical experience on addressing the additional cost issue, it is becoming more evident that other barriers, such as the lack of a timely and efficient provision

of transmission services, are becoming a larger impediment to achieving ambitious renewable energy targets. This report addresses the transmission barrier to renewable energy.

### 1.1.1. The Barriers to Renewable Energy

The barriers to the deployment of renewable energy have been largely documented, especially concerning the additional cost issue.<sup>1</sup> Empirical evidence and analytical work describe the strengths and weaknesses of different policies and financing mechanisms—carbon pricing, feed-in tariffs, cap-and-trade, or renewable energy certificates—used to address such barriers. In order to understand better other barriers to renewable energy, which have received less attention, it is useful to look at renewable energy from the perspective of a private renewable energy developer. A developer seeks a competitive return on its investment commensurate with the risk. The critical aspects to a successful renewable energy project from a developer's perspective are as follows:

- A site that is well suited to the renewable technology. For example, a good wind energy site should have persistently high wind speed and be located near the grid or load centers. Unfortunately, more often than not, good resource sites that are available tend to be located in remote areas. Obtaining rights to exploit the site will depend on the concession process and related social and environmental permits. Since the transaction costs associated with the above permitting are generally high, it would be desirable for a developer to keep such transaction costs to a minimum.
- A ready buyer willing to pay a reasonable price for renewable energy, often higher than conventional energy. This buyer is likely a vertically integrated utility, a distribution company, or an individual consumer.
- A long-term revenue stream to cover expenses and provide a reasonable return on investment. The source of this revenue stream could be a long-term power purchase agreement (PPA) or an equally stable revenue source determined by a specific regulation, which usually entails government support. Because of renewable technology's variable output (for example, wind or solar), a stream with a

<sup>1</sup> See, for instance, World Bank 2010a and Beck and Martinot 2004.

capacity-like payment that ensures full cost recovery and return would be desirable.<sup>2</sup>

- A transmission connection that links the project to the grid. Absent connection, projects will never materialize. Even if a connection can be made, high costs or delays can either modify the scale and scope of the project or prevent its development. Hence, a connection process that results in a reasonably fast and low-cost connection is an essential feature for a developer.
- A transmission service tariff that is cost-effective. Independent power generators pay for the use of the transmission network in various ways. Since many renewable energy technologies (such as wind, solar, and hydropower without storage) have variable output, a tariff based on peak or nameplate maximum output, megawatts (MW), could result in a prohibitive cost per megawatt-hour (MWh). Alternatively, if tariffs are determined based on distance measures, renewable generation projects far from their off-takers could also face high transmission costs. A cost-effective tariff is therefore a desirable feature. In addition to transmission costs, the costs of any other systemwide services (system operation charges or other services, such as imbalance energy or backup energy) should be competitive.

Considerable attention has been given to tackling the first three desirable features, which require making appropriate policy and regulatory decisions. However, less attention has been paid to addressing the last two issues, which are increasingly appearing as a major barrier to scaling up renewable energy. As discussed later in the report, providing transmission services to renewable energy is complex. Investment needs are increasing, and existing expansion practices both from the planning perspective and the regulatory perspective are challenged.

### 1.1.2. Why Developing Transmission is a Challenge to Scaling up Renewable Energy

The most viable solar and wind renewable energy sites are more often than not located far away from energy consumption centers and the existing transmission systems. Contrary to conventional fossil fuel-based

power sources, selecting a site to exploit certain renewable energy resources has few or no degrees of freedom. While the decision to locate a fossil fuel power plant can involve pondering two sites, given their differences in fuel or electricity transmission costs, locating a wind or solar power cannot make such trade-offs without structurally affecting the quality of the exploitable resource and its economics. In other words, renewable energy technologies, such as wind and solar power, are site-constrained. Transmission needs to get to the source and not the other way around.

Besides such location constraints, the dispersion and granularity of renewable sources, such as wind or solar, adds to the transmission challenge. Large hydropower may have scales (for example, 1,000 MW) whose economics can support the transmission investments (for example, with US\$100 million) required to deliver their energy production. Harnessing the same amount of energy from wind or solar power will likely require the development of several dispersed sites, all of which in turn will require transmission infrastructure. To understand the granularity issue, consider, for example, that the 26,047 MW of total wind power additions in the United States during 2006–09 came from 546 different sites whose average size was 90 MW (U.S. DOE 2008). Clearly, the dispersion and granularity of such renewable source is likely to trigger transmission investment needs whose cost could be harder to be absorbed by individual site developers. In addition, the dispersion or granularity characteristics bring implementation challenges for transmission utilities from the planning, construction, and environmental points of view.

The combination of the factors described above has led to a scenario where both developed and developing countries’ plans to scale up renewable energy are being challenged by the need to efficiently and effectively develop the required transmission facilities. On the one hand, some developed countries that had well-developed networks at the beginning of their scale-up efforts have found that achieving more ambitious targets will require a considerable overhaul of their transmission systems. On the other hand, developing countries are facing the transmission challenge even in the early stages of their scale-up efforts because of the location mismatch of renewable energy, and also

<sup>2</sup> *Variable or variability* is a term used to describe mostly uncontrollable power fluctuations from wind and solar photovoltaic generation that appear in the timeframe of a few minutes. Even though any generation technology output is not 100 percent and varies to some extent, the variability of new renewable energy technologies is highlighted because not all system operators are familiar yet with this different form of less controllable variability.

because their transmission systems are frequently less developed or extended across their territories.

While the need to scale up transmission investments is clear, the impact of these investments on renewable energy policies—for example, on selecting the best technology options to achieve certain policy goals—has not been consistently addressed. Although the implications of transmission costs to suppliers and consumers are highly dependent on the particular geographical conditions and existing state of development of the transmission network, the emerging evidence shows that planning is an important factor in ensuring that transmission investments are developed in a timely and cost-effective manner.

Short construction lead times for renewable energy technologies necessitate faster delivery of the transmission infrastructure if compared to most conventional power sources. The construction of transmission infrastructure for conventional power sources formerly was started after the construction of the power plan had begun. This had been possible, given that lead times for most conventional power sources (a few years) are longer than for building the transmission infrastructure (a couple of years). A wind power project of average size (100 MW) could take as little as eight months to complete from the beginning of construction to operation. This is much less than the time it would take to build an average, say, 100 km of transmission lines at 230 kV.

As detailed later in this report, planning for providing transmission facilities for renewable energy has become of paramount importance, not only for the timely connection of renewable energy, but also to reduce its cost. The need for transmission to be planned and developed ahead of time for renewable energy introduces an additional challenge. Traditional transmission planning practices can result in long delays in renewable energy projects. This, often called a “chicken and egg” problem, has added up to the other known transaction costs of renewable energy.

The location, granularity or dispersion, and lead times characteristic of renewable energy create some challenges not only to existing transmission planning practices, but they also bring questions to traditional pricing rules for transmission services. Traditional planning and transmission pricing regulations, whose main principles had been designed during the era when

competition and open access had been introduced to the industry, are often perceived as ineffective or disadvantageous for renewable generation. For example, cost allocation rules that require generators to pay all transmission expansions and reinforcement that are triggered by the request could be seen as disadvantageous to the smallest renewable developments located in remote areas.

This report focuses on these long-term aspects related to developing the required transmission infrastructure to renewable power sources. The report describes the investment challenges and reviews emerging policy and regulatory approaches. These approaches reflect the need to change the philosophy of the planning function from a reactive to a more proactive mode and, when required, to efficiently improve the cost allocation and pricing rules of the transmission system. Other aspects reviewed in this report include the need for rethinking the institutional model of transmission development. The report also describes the usefulness of new methodological approaches and tools for transmission planning. Finally, it defines some general economic principles that can help transmission utilities and regulators develop transmission planning and pricing policies in relation to renewable energy scale-up efforts.

### 1.1.3. Other Challenges Associated with Transmission Not Covered in This Report

Other network-related challenges must be tackled when scaling up renewable energy. In the short term, these challenges relate to real-time operational issues that arise when integrating considerable amounts of variable renewable energy, such as wind and solar power. Generation from wind and solar power is inherently intermittent, and current technologies still offer less controllability than traditional power sources. Even though transmission companies and system operators have always dealt with uncertainty and limitations in operating various power equipments, these technologies have brought two new dimensions to short-term power system operations. First, wind or solar power output can change drastically, within minutes, and require scheduling functions to quickly respond by pooling other generation sources and reserves in order to maintain the balance between supply and demand. As the amount of variable sources in the power system increases, the operational challenges multiply. The operational experience with renewable energy is rapidly increasing (for example, Denmark, Germany, Spain, and the United



States), and transmission and system operators are learning how to deal with this form of variability.

Second, variable renewable generation technologies do not always have the same control capabilities in voltage and frequency as other conventional, more controllable, power sources. In order to maintain the efficient and reliable operation of the system, system operators are implementing different software and hardware solutions to ensure that voltage and frequency (the two vital sign of the system) remain in normal operating condition despite the scarcer controllability characteristics of such technologies. These solutions include the use of improved forecasting in short-term dispatch operations, and better systemwide controls and protections. Advances in voltage and frequency control of newer wind power plants are also playing an important role in managing these challenges better. These include pitch control in newer wind power generation technologies, which offer some degree of controllability of the power output.

Besides these technical challenges, there are increasing complexities in obtaining rights of ways and addressing the social and environmental issues that surround the siting of new transmission facilities. Some countries are taking measures to make more efficient the process of acquiring land rights and obtaining social and environmental clearances when they relate to energy projects of national importance, such as a large hydropower development.

While these short-term technical operational challenges and social and environmental issues described above are equally important for transmission development, they require separate treatment. For this reason, they are not dealt with in this report.

The remainder of Chapter 2 focuses on describing how scaling up investment in transmission is a major effort to be undertaken when scaling up renewable energy. The challenge seems equally important in developed countries that have already substantially increased supplies from renewable energy, as well as in developing countries in their initial scaling-up efforts.

## **1.2. The Need for Scaling up Transmission When Scaling up Renewable Energy**

The transmission investment needs for renewable energy are increasing in both developed and developing countries. Considerable investment needs are being

reported by different countries in the context of their scale-up plans. Two primary avenues exist by which these investment needs are being identified. One is the results of long-term assessments that seek to determine investment needs related to specific renewable energy target programs or goals. The core of such assessments is usually a long-term technical planning exercise that focuses on determining transmission investment needs and other implications of renewable targets. The other avenue is transmission needs revealed from immediate needs to connect specific projects.

While the long-term assessments have different time horizons and assumptions about the level of renewable penetration considered, they demonstrate that scaling up renewable energy equally requires the scaling-up of transmission investments. On the one hand, some countries that have already reached a certain level of scale-up of transmissions for renewable energy, such as the European Union, United Kingdom, and United States, are setting up more ambitious targets for their transmission investment. On the other hand, countries that are in the initial stages of scaling up renewable energy are finding that transmission investment needs for specific projects are also considerable and have required new treatments from the planning and regulatory perspective.

The following sections describe some of the needs identified by both long-term plans to scale up renewable energy and by immediate needs triggered by specific projects in different countries, which at the time of writing this report are in the early or final stages of construction.

### **1.2.1. Findings from Long-Term Needs Assessments in Developed Countries**

In the European Union, United Kingdom, and United States, several studies to understand the implications of meeting different renewable energy targets on transmission needs have been undertaken. Each of the studies express the significant investment requirement for transmission expansion to achieve the set renewable energy targets. Following are transmission investment findings from long-term needs assessments in the developed countries.

To meet the increasing electricity demand and reach the 20 percent wind energy target, the United States would need to increase its wind capacity by 290 GW by 2030

(U.S. DOE 2010b). Most of the wind energy would be derived from the Midwestern United States, California, and Texas—all pursuing important renewable energy programs. According to the study by National Renewable Energy Laboratory (NREL), to accommodate the increase in wind energy, the United States needs to invest US\$60 billion for the period 2008–30 in order to achieve a 20 percent wind energy share in its energy supply (U.S. DOE 2008).

Detail assessments in certain regions within the United States are also revealing. The Midwest ISO service territory covers parts of 13 U.S. states and the Canadian province of Manitoba. For the period between 2015 and 2025, each state has established varying renewable energy targets from 3.5 percent up to 30 percent, which we expected to be satisfied mainly through wind energy. Based on the Midwest ISO Regional Generation Outlet Study (RGOS), the additional investment requirements for transmission facilities are estimated to be in the range of US\$13–15.1 billion, under varying Renewable Portfolio Standards (RPSs) target assumptions for each state, as well as various transmission overlay solutions. It is notable that the Midwest ISO is expanding its transmission significantly. In fact, the estimated investment needs for 2011 are estimated to be US\$5 billion—five times the average annual new transmission investment.

In Texas—which leads wind power generation in the United States and ranks fifth overall in the world with 9,528 MW of wind power installed capacity—transmission expansion is primarily driven by the scale-up of renewable energy generation, especially wind power. Thus far, Texas has invested US\$5.78 billion for the new transmission since 1999, and currently US\$8.2 billion are being spent under the five-year plan, including US\$5 billion solely to accommodate 18,000 MW of wind power capacity (ERCOT 2010a).

The United Kingdom, which consists of England, Ireland, Scotland, and Wales, has established the target of 20 percent renewable generation by 2020 through the Climate Change Act of 2008. As of 2008, total production of electricity from renewable sources accounted for 6 percent of total generation. This value is expected to reach the level of 31 percent, overtaking the target of 20 percent by 2020, provided that existing power plants are closed in line with existing retirement dates (DECC 2009). For the past 20 years, the renewable obligation (RO) mechanisms have been the main driver behind the growth of renewable energy with

biomass and wind power being the main contributors to this growth. To accommodate this rapid growth in renewable energy, the Office of the Gas and Electricity Markets (OFGEM 2009) estimated that the United Kingdom should invest about US\$7.7 billion over the next 10 years, based on the current investment plans of the transmission companies for reducing carbon emissions by 2020. The greater investment requirements specific to the United Kingdom are the result of interconnecting wind power generated in the north (Scotland) and transmitted to the main consumption centers in the south. Investment in the past six years has already been considerable. In 2006, when the allowed revenues for transmission companies for the period 2006–12 were established, it became evident that investment in transmission needed to be scaled up. The approved capital expenditures for the three transmission companies for the 2006–12 period more than doubled from £1,676 million to £3,786 million compared to the previous period. For the Scottish Power Transmission Limited (SPT) in southern Scotland, where most of the wind power potential is located, their approved capital expenditures tripled.

In order to continue the development and deployment of renewable energy technologies, the European Union adopted the 2009 Renewable Energy Directive, which included a 20 percent renewable energy target by 2020 for the European Union. In 2020, according to the Renewable Energy Directive's 27 National Renewable Energy Action Plans, 34 percent of the European Union's total electricity consumption should come from renewable energy sources, including 495 TWh from wind energy representing levels equivalent to 14 percent of consumption (EWEA 2011). Strong growth of renewable electricity sources have already started to cause network congestion resulting in certain regions of Spain and Germany to periodically switch off their wind turbines during periods with high winds. The European Union grids must be urgently extended and upgraded to foster market integration and maintain the existing levels of the system's security, but especially to transport and balance electricity generated from renewable sources, which is expected to more than double during the period 2007–20. A significant share of generation capacities will be concentrated in locations farther away from the major centers of consumption or storage. Up to 12 percent of renewable generation in 2020 is expected to come from offshore installations, notably in the northern seas, resulting in significant investment in transmission expansion. According to the European

Grid Study 2030/2050 by Energynautics (2010), the European Union would need to invest US\$66.5 billion to US\$93.1 billion for its transmission by 2030, or US\$164.9–198.2 billion by 2050. It is evident that for developed countries to achieve their more ambitious renewable energy targets, massive investments in transmission upgrade and expansion are required. Further details on each of the countries and regions can be found in Appendix A of this report. A summary of the different assessments is presented in Table 1.1.

### 1.2.2. Findings from Immediate Investment Assessments from Developing Countries

Countries at their early stage of the scale-up of transmission for renewable energy are focusing mostly on planning immediate investments for specific transmission expansion projects. Nonetheless, similar to developed countries, the immediate investment needs for transmission expansion for developing countries are significant. Following are some of the transmission investment requirements for developing countries.

The Government of Mexico has been increasingly supporting the development of renewable energy projects by allowing private participation in the generation sector since 1992. Specific targets for renewable energy generation in the electric power sector were introduced only until 2010 by the National

Energy Strategy (Secretaría de Energía 2010). The target includes achieving a 35 percent share of renewable energy in term of generation by 2024. The share of renewable generation technologies in 2008 (CFE 2010) was 23.7 percent, from which 21.7 percent was hydroelectricity, 1.8 percent geothermal power, and 0.2 percent wind power. La Ventosa, one of the richest wind resource areas in Mexico, has the wind potential estimated between 5,000 MW and 6,000 MW with capacity factors of up to 40 percent. The region is critical to achieve renewable energy targets. Currently only 84.65 MW of wind power capacity are operational in the area; however, projects in operation will increase to 2,745 MW by 2014 and majority of these projects (1,967 MW). La Ventosa is located far away from consumption centers and this has triggered the need for massive expansion to existing transmission network which will be owned and operated by the private sector supplying large industrial consumers at privately negotiated energy prices. To raise the current 84.65 MW of wind power capacity to 2,745 MW by 2014, US\$260 millions investment in transmission network is required. These investment needs triggered a new treatment for the planning and cost allocation of the facilities as will be described in future chapters of the report.

While the Government of Panama has not established specific targets for penetration levels of renewable energy technologies, the government has increased

**Table 1.1: Summary of Long-Term Investment Needs Assessments for the European Union, United Kingdom, and United States**

Country	Investment (US\$ billion)		Assumptions	Timeframe
United States	US	60 <sup>a</sup>	20% wind energy	2008–30
	Midwest ISO	13–15.3	Midwest RGOS	2015–25
	Texas	4.9	CREZ TSO Scenario 2 with 18,500 MW of wind generated power	n.a.
United Kingdom	UK	7.7 <sup>b</sup>	20 transmission investment projects during the period 2010–20	2010–20
European Union	66.5–93.1 <sup>b</sup> (€50–70)		Base Scenario 2030, by European Grid Study 2030/2050	By 2030
	164.9–198.2 <sup>b</sup> (€124–149)		2050 Grid without import, by European Grid Study 2030/2050	By 2050

Source: OFGEM 2009, U.S. DOE 2008, Midwest ISO 2010c, ERCOT 2008, and Energynautics 2010. See Appendix A for further information.

n.a. Not applicable.

<sup>a</sup> In undiscounted terms.

<sup>b</sup> IMF foreign exchange rates applied from the year the study was done.

its support to such technologies through the approval of different incentives. Law 45, approved by congress in 2004, sets forth a set of incentives for small power generation projects with renewable energy technologies, including hydro, geothermal, wind, solar, and other renewable energy technologies. Panama has especially rich hydro and minihydro renewable energy resources. While other sources, such as wind, are expected to increase their participation, small minihydro generators are the technology sources representing an increasing challenge for the transmission company. Post approval of Law 45, 21 projects with a total capacity of 172.2 MW in the basins of the rivers Chiriquí, Chiquiri Viejo, and Piedra have requested interconnection to the existing transmission grid. In order to interconnect these projects, the transmission company's expansion plan considers the expansion of caldera substation. which is estimated to cost US\$12.29 million to interconnect with a significant number of minihydro plants. While the total investment amounts seems small, the lack of clear cost-recovery rules for these assets is having important financial implication for the transmission company.

Egypt's current energy portfolio mix consists mainly of hydro, wind, and thermal generation. In February 2008, the Supreme Council of Energy of Egypt, headed by the prime minister, approved a plan to generate 20 percent of the total energy generated from renewable sources by 2020. To achieve this goal, New and Renewable Energy Authority (NREA) plans to add 600 MW in wind power and 140 MW in hybrid solar thermal technology generation in the by 2012, followed by 3,600 MW in wind power and 150 MW in concentrated solar power technology in FY12–17. The Wind Atlas of Egypt identifies several geographic regions with Gulf of Suez leading the wind resource potential. One of the projects supported by the World Bank and currently under way is the 250 MW, build-own-operate (BOO) transmission project that will connect the future wind parks at Gulf of Suez and Gabel El-Zait to the national transmission network. To integrate the high potential wind power in the region by connecting the Gulf of Suez-Wind farm, Gulf of Suez-Salamut, Gulf of Suez-Gabel El-Zait, and the extension of Salamut substations, the transmission investment is estimated at US\$299.70 million. Developing such transmission expansion required

support to the utility from the government and the international financial community.

Brazil has one of the world's cleanest energy matrixes, with 85.3 percent of overall energy production coming from hydro and other renewable sources. One of the most promising sites for biomass renewables in Brazil is the Center-West region, which includes parts of the states of Mato Grosso do Sul and Goiás. The challenge to integrating these small renewable projects comes from two factors: first, their dispersed location and, second, their distance to existing distribution or transmission networks. Brazil is working on Mato Grosso do Sul and Goiás project to integrate about 80 biomass cogeneration and minihydro plants of total capacity of 4,100 MW at an estimated cost of US\$400 million. The capital cost of the transmission networks to interconnect renewable had been found to be larger than the overall capital value of some of the distribution areas in the vicinity of the resources. This required a new treatment to plan and develop these investments by new sub-transmission service companies (TSCs). The Philippines is well known to have tremendous potential of wind, hydro, and other renewable energy sources and recently enacted the Renewable Energy Act (RA 9513; Congress of the Philippines 2008). The RA 9513 provides an institutional framework and general guidance to foster the development and utilization of renewable energy in the Philippine including specific provisions regarding transmission expansion. With support from the World Bank, the Philippines conducted a preliminary transmission planning exercise and reached a conclusion that the transmission investment needs can be highly considerable and depend on the planning strategy used to reach biomass, wind, and hydro potential renewable energy sites.

As evident by the above examples, similar to developed countries, the immediate investments for specific transmission expansion projects in developing countries are significant and are creating the need to adjust existing planning and regulatory models to develop transmission. Table 1.2 summarizes the transmission expansion projects in immediate needs for the aforementioned countries.

**Table 1.2: Immediate Investment Needs—Brazil, Egypt, Mexico, Panama, and the Philippines**

Country	Investment (US\$ million)	Projects	Related RE source
Mexico	260.00	La Ventosa project	Wind
Panama	12.29	Caldera substation expansion project	Minihydro
Egypt	299.70	Gulf of Suez and Gabel El-Zait	Wind
Brazil	400.00	Mato Grosso do Sul and Goiás project	Biomass, Minihydro
Philippines	170 or 192	Potential projects of biomass, wind, and hydropower for a total of 589.4 MW	Biomass, Wind, and Minihydro

Source: Various sources compiled by the authors. See Appendix A for further information.



## 2. TRANSMISSION COST ALLOCATION AND PRICING

As mentioned above, large-scale renewable energy generation sites are often located far from the existing transmission network or load centers. Therefore, as renewable generation increases, so does the need to expand infrastructure to connect these remote generation sites to the existing transmission network. Successful integration of renewable generation sites could require extensive investments in the transmission network. In order to understand the implications for the renewable energy generators and transmission providers better, the following section describes typical transmission investment needs triggered by generation projects. The section also overviews how the costs associated with these needs are traditionally allocated.

Pricing of transmission is seen frequently as disadvantageous for renewable energy. While transmission pricing is a highly complex matter and no standard pricing method is globally accepted, it is important to understand the primary aspects of transmission cost allocation and pricing and their potential impacts on renewable energy and consumers. This chapter will review these aspects and overview relevant international experience. In the context of this experience, Part II of the report analyzes and describes some general principles that any specific

implementation of efficient transmission cost allocation and pricing should follow.

### 2.1. Classification of Transmission Needs Triggered by Generation

The transmission needs triggered by the interconnection of generation projects, renewable or otherwise, can be broadly categorized as either connection assets or network assets. Connection assets are defined as assets required for the sole use of interconnecting generators with the existing transmission network. Connection assets could include enabler facilities or the immediate connection assets of the generator, such as the internal substation and transformer. Connection assets could also include the long-distance and high-voltage transmission facilities required to connect the enabler facility (generator substation) to the existing network. These transmission facilities are known as system extensions (see Figure 2.1). Traditionally, the system extension is considered part of the connection assets as long as the generator is the sole user of the extension (Scott 2007).

Network assets, by contrast, also known as reinforcements, refer to transmission network upgrades beyond the connection assets, which are required to accommodate the new generation capacity. Reinforcement may be required because existing trunk lines or substations may not be able to accommodate

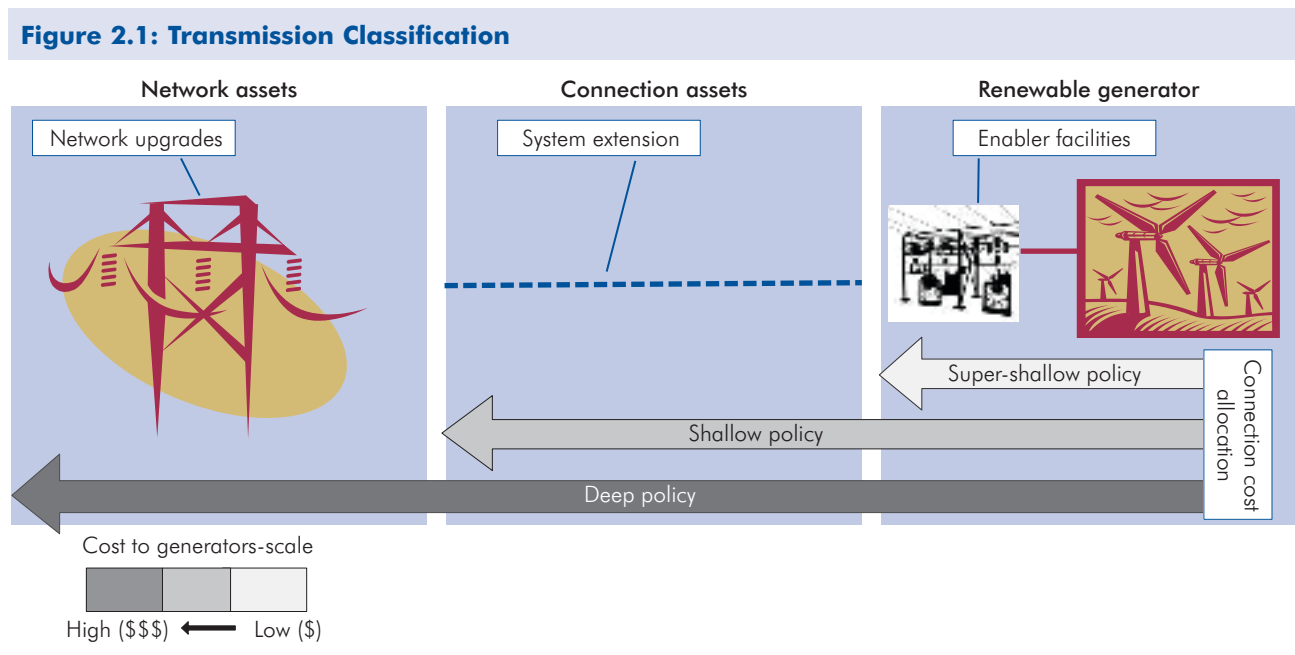

Source: Prepared by the authors.

the additional power injection under normal operating conditions or stay in compliance with the reliability standards under the new conditions. Reinforcements could include upgrades to existing high-voltage lines or additional lines, plus additional transformation capacity at substations.

Both connection assets and network assets collectively define the investment requirements for connecting new generation to the existing transmission network as depicted in Figure 2.1. The way in which transmission regulation recoups the costs of the needed investments can greatly impact the viability of renewable generation. In Chapter 2, the section on Interconnection Cost Allocation explains how connection and networks cost are traditionally allocated and qualitatively describes the potential impacts on renewable energy generation.

## 2.2. Interconnection Cost Allocation

As stated in the Chapter 1 section, The Barriers to Renewable Energy, one of the major challenges of renewable energy is the higher upfront cost of transmission investment triggered by new generation. In some cases, this network connection cost is allocated entirely to the project developer, while in other cases, the transmission investment is shared among various stakeholders. To address this issue, countries have adopted varying policies on network connection cost allocation, which will be overviewed in this section.

Traditionally, with conventional power generation, the project developer would bear all transmission network connection costs to put a generation plant online. The economic scales of conventional power generation projects traditionally allowed for absorbing transmission connection costs. Additionally, conventional power generation, such as fossil fuel-based generation, permits greater flexibility in selecting locations closer to demand centers and the existing transmission network. However, allocating the transmission connection costs to a renewable generation developer can have a much greater impact. This is especially acute when renewable generation resources are located far away from the existing network, for instance, offshore wind farms or solar power plants in desert areas.

To alleviate this impact on renewable developers, various cost-curtailling strategies are applied to redefine what is considered a connection or network asset and how their costs are allocated between the generator, the

transmission provider, and the consumers. Different jurisdictions have adopted varying policies to allocate the cost of connection and network assets, which are ultimately described in transmission pricing regulations. In most cases, connection assets boundaries are set at either enabler facilities, system extension, or beyond network upgrades (refer to Figure 2.2). These policies define the cost allocation boundary between the generation and the transmission system operator (TSO), leading to four broad connection cost allocation policies. These categories are usually described as (a) super-shallow, (b) semi-shallow, (c) shallow, or (d) deep connection cost allocation policies (Scott 2007).

### 2.2.1. Overview of Interconnection Cost Allocation Policies and Practices

The following subsection describes the four cost allocation policies and lists examples of various countries and jurisdictions that have adopted such cost allocation policies.

#### 2.2.1.1. Cost Allocation Policies: Super-Shallow, Semi-Shallow, Shallow, and Deep

Typically, transmission costs are allocated between the project developer and the TSO using one of the four cost allocation policies, which include (a) super-shallow, (b) semi-shallow, (c) shallow, and (d) deep connection cost allocation policies. In a super-shallow cost allocation policy, the connection assets boundary is set at enabler facilities. With such a connection cost allocation structure, the project developer is solely responsible for the costs of enabler facilities, which in certain cases are shared by the TSO. All costs associated with system extension and network upgrade are borne by the TSO and in turn shared by all the users connected to the grid, as determined by the applicable network pricing methodology. From a financial investment perspective, a super-shallow cost allocation policy would be an ideal scenario for a renewable generation developer, since it would bear the least cost of interconnection to the existing network.

In a shallow cost allocation policy, the connection assets boundary includes system extension costs, in addition to enabler facilities. This is typically the case in situations where system extension and enabler facilities are constructed for the sole use of the renewable energy developer requesting connection. With such a connection cost allocation structure, the project developer is solely



responsible for both the system extension and enabler facilities costs. This can require significant upfront investments from renewable developers, especially when offshore wind or remote solar power plants are considered. To ease the investment burden, some jurisdictions have adopted a semi-shallow cost allocation policy, whereby TSOs and renewable project developers share the costs associated with system extension. However, the costs associated with enabler facilities are still solely the responsibility of renewable developers.

In a deep cost allocation policy, the connection assets boundary also includes network upgrades. With such a connection cost allocation structure, the renewable project developers are responsible for all transmission costs, including enabler facilities, system extension, and network upgrades (reinforcements) associated with new generation. Because of the high upfront costs, the deep connection charging policy may discourage renewable project developers and, in certain cases, render the renewable energy projects economically unviable.

While the conditions are highly dependent on the location of the renewable resource and existing transmission

network, the above-mentioned connection cost allocation policies (super-shallow, semi-shallow, and shallow) can greatly impact the economic and financial feasibility of renewable energy generation. From the renewable generator perspective, a super-shallow connection cost allocation policy is always better, as long as other costs are allocated broadly through network pricing.

Independent of the connection cost allocation policy adopted, such costs are usually charged in one of the following ways. The first alternative requires an up-front and often on-time payment of the connection infrastructure cost prior to any commitments from the TSO to build an infrastructure. In the second alternative, connection costs are charged by means of a connection cost tariff that is paid exclusively by the interconnecting generator over a period of time. The tariff is determined on the basis of an amortization calendar of the connection costs and is usually paid in monthly installments, together with other network or system costs.

Table 2.1 display examples of interconnection cost allocation policies adopted by different countries and regions. Some are existing policies, while others were

**Table 2.1: Connection Cost Allocation Policy**

Country/ region	Infrastructure cost allocation policy	Cost bearer		
		Enabling facilities	System extension	Network upgrades
Spain	Shallow policy <sup>a</sup>	G	G	TSO
Germany	Shallow policy <sup>a</sup>	G	G	TSO
Denmark	Shallow policy <sup>b</sup>	G	G	TSO
United Kingdom	Super-shallow policy <sup>c</sup>	TSO	TSO	TSO
Texas	Semi-shallow policy <sup>c</sup>	G	TO (CREZ)	TSO
Mexico	Deep policy	G	G	G
Panama	Semi-shallow policy	G	TSO	TSO
Brazil	Shallow policy	G	G	TSO
Philippines	Semi-shallow policy*	G	G	TSO
Egypt	Semi-shallow policy*	G	TSO	TSO

Sources: a. Cambridge Economic Policy Associates Ltd. 2011. b. Scott 2007. c. Frontier Economics Ltd., 2009.  
 Notes: Panama—No infrastructure connection costs allocated to generator for renewable generation < = 10 MW. Brazil—Small-scale renewable generators use integrated network and share associated connection costs. Philippines—System extensions are initially financed by the TSO. Costs are later recouped from the generator.  
 G: Generator.  
 TO: Transmission owner.  
 TSO: Transmission system operator.  
 \*Denotes that the policy is under consideration and not currently enforced.

recently developed to address specific renewable energy integration efforts. Details about cost allocation policies for each country listed in the Table 2.1 are provided in Appendix B.

Several countries have adopted different policies to accommodate the higher investment costs to connect offshore wind farms to existing transmission systems. Table 2.2 summarizes jurisdictions that have adopted different policies for offshore wind generation.

Connection cost allocation policies can have direct financial implications on renewable generation projects and render them less attractive for investors. A shallower connection cost policy would be more attractive from the perspective of generators, but such policies do not allocate sufficient costs to generators to recoup total investment. The remaining transmission assets are considered part of the transmission network and, as such, they are part of the cost base used to determine network usage prices. The following section reviews the network pricing methodology and qualitatively describes how they can impact location-constrained renewable energy projects.

### 2.3. Network Infrastructure Pricing

In the previous section, we highlighted several connection cost allocation methodologies associated with connecting generation to the existing transmission infrastructure and shared examples of connection asset boundaries established by various countries and regions. In this section, we will provide an overview of the costs associated with usage of the transmission network. These network usage costs are relatively small compared to total energy delivery costs. Transmission usage costs reflect mainly the investment and operating

cost of maintaining and developing the transmission network, including losses and congestion. In addition to investment and operational costs, other costs that include ancillary services and system operator costs are also sometimes considered an integral part of the transmission.

Under most regulatory regimes, the transmission owner, which can also be a system operator or a vertically integrated utility in some cases, will receive regulated yearly revenues to cover the above-mentioned costs. The regulated revenues could include an adjustment for efficiency improvements or quality of service regulations. The regulated revenues will be obtained from tariffs applied to users of the network. These charges are usually called use of system (UoS) charges.

Although UoS charges typically amount to a small percentage of the total costs for consumers, depending on the transmission pricing methodology utilized, charges can have different impacts on renewable energy generators in remote locations. In addition to connection costs, UoS charges can also facilitate or hinder the development of renewable energy generation. This transmission regulation and pricing is still an ongoing debate; there is no clear answer as to the “best way” to regulate the transmission sector. This section will provide an overview on the most important aspects that seem to affect renewable energy.

One of the first important aspects of transmission network pricing is whether regulated revenues of the transmission system will be recouped from load consumers or generation consumers, or both. This is one of the first design aspects that transmission pricing faces in most institutional structures where the transmission activity is separated from other activities in the sector. While the users of the transmission system are generation and demand (distribution utilities, and unregulated and regulated consumers), transmission pricing methodology can allocate cost either to generation or demand, or both, in varied proportions. Since in the long term all transmission costs will be passed on to consumers, a line of thought suggests that generation need not be charged for transmission network costs. While the argument sounds reasonable, concerns still remain on the impacts of such an allocation on efficient short-term operation and investment by generation. These issues will be reviewed later in the report.

**Table 2.2: Connection Cost Allocation Policy**

Country/region	Offshore wind policy
Spain	Shallow policy* <sup>a</sup>
Germany	Super-shallow policy <sup>a</sup>
Denmark	Super-shallow policy <sup>b</sup>
United Kingdom	Super-shallow policy* <sup>c</sup>

Sources: a. Cambridge Economic Policy Associates Ltd. 2011. b. Scott 2007. c. Frontier Economics Ltd. 2009.  
\*Denotes a similar connection cost allocation policy for onshore and offshore renewable generation.

### 2.3.1. Overview Network Infrastructure Pricing Methodologies

Once the network connection costs have been allocated among the transmission users, the UoS charges to each individual generator and load must be determined. For the purpose of illustrating qualitatively how network pricing could affect renewable energy, this report overviews the principles behind the two major broad categories in which most network transmission pricing methodologies can be categorized. We will call these two categories postage stamp-based methods and usage-based methods.

#### 2.3.1.1. Postage Stamp Methods

Postage stamp methods refer to when all transmission users pay the same average rate regardless of whether the cost caused or benefit derived by that user from a given transaction varies from the average (Hempling 2009). This concept is similar to a postage stamp for in-country mail, which carries a flat rate irrespective of the sending or receiving destination.

This is the simplest pricing methodology where a user is charged a flat rate based on the amount of energy transmitted or injected on the network. Sometimes networks are divided into zones and each zone is priced using a postage stamp method (Stoft, Webber, and Wiser 1997). Postage stamp methods provide a simple and effective way to recover fixed costs, but they do not take distance-related or network congestion conditions and associated costs into account (Krause 2003). This flat rate can be derived either based on the energy (MWh) or maximum load (MW). For basic mathematical formulation of the network pricing methods discussed in this section, see Appendix B.

#### 2.3.1.2. Usage-Based Methods

Usage-based methods refer to when transmission network users are charged based on a metric that represents the extent to which they “use” the network. While it is theoretically impossible to clearly separate how different users place a burden on the network, there are some methods that could be used to come up with metrics that offer good engineering-based proxies for the use of the network. Most usage-based methods

use power flow simulations, which can determine how the flow in each network element changes as a function of a user (generation or demand). Usage-based methods can be categorized as flow-based or distance-based MW mile. The difference between these two is that flow-based methods place a heavier burden on energy transactions that “travel” a greater distance. See Appendix B of this report for further details.

With regard to renewables, determining UoS charges derived from usage-based methods can be disadvantageous. This will be especially applicable for bilateral transaction where the supplier is a renewable generator located far away, in flow or in length terms, from its off-taker. If the connection cost allocation policy does not allocate the cost of the connection to a generator, but the network pricing methodology is based on usage, UoS charges place the full cost of the connection back on the generator. While the full range of situations can vary greatly with the geographical conditions and the characteristics of the network, usage-based methodologies are usually considered disadvantageous for renewable energy generation. Similarly to postage stamp, implementing usage-based formulas in per-megawatt measures, and not megawatt-hours, would further hinder the growth of renewable energy.

Network pricing methods often use a combination of the above-mentioned methods to take advantage of their desirable features for a particular application. Sometimes when a short-term locational priced energy market is in operation, the congestion rents generated in the short-term market are counted toward the total cost of transmission.<sup>3</sup> As is well known, congestion rents make up only a fraction of the total cost, and the majority of the costs are still determined based on any of the UoS charges mentioned above. Appendix B provides a brief description of infrastructure pricing methodology adopted by various countries, which is summarized in Table 2.3.

Figure 2.2 provides the broad categories in which interconnection costs and network costs can be allocated to generation and load and depicts a qualitative representation of the cost impact on generation. The least connection cost allocated to generation (super shallow policy) will have the least impact on renewable

<sup>3</sup> Congestion rents are the difference between payments of generators and loads in the short-term (nodal or zonal) spot energy trades. Congestion rents are zero only if the transmission network is decongested.

**Figure 2.2: Allocation and Pricing of Transmission Costs**

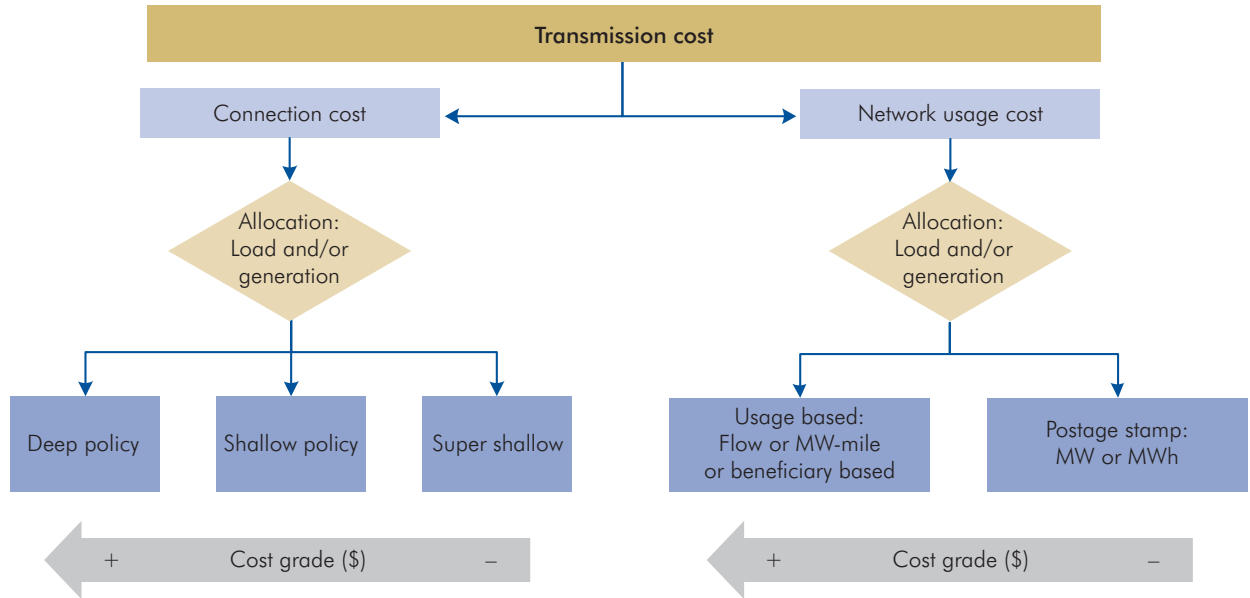

Source: Prepared by the authors.

energy. Similarly, the farther away renewable energy is located from consumption and the more usage-based network pricing methodologies are used, the more the impact will be on renewable generation.

### 2.3.2. An Example of the Impact of Transmission Cost Allocation and Pricing

An illustrative example on the impacts of different cost allocation and network pricing methods on the equivalent levelized costs of electricity for renewable energy is presented next. As seen in the example, the equivalent cost is highly dependent on the approach followed. While this is also true for any discussion on the impacts of transmission pricing options for conventional sources, the objective of the example is to illustrate that smaller-scale and more remote sources can be highly sensitive to transmission costs from the generator perspective.

The analysis uses a simple financial model, which estimates the levelized cost of electricity (LCOE) from a 50 MW wind farm with 30 percent capacity (see Figure 2.3). Different pricing assumptions are made for both the transmission connection and network usage costs. The characteristics of the network are presented in Figure 2.3. The figure describes characteristics of both the existing transmission and generation system.

The wind generator cost characteristics were derived using data from ESMAP (2006). A real discount rate of 5 percent is assumed. The costs of the substations and high-voltage lines were derived from typical values using the catalogue of transmission costs published by the Comisión Federal de Electricidad (CFE) in Mexico for substations and voltage lines with similar technical specifications. The cost of the 115 kV line connecting the wind generator to the main transmission system substation is considered at US\$220,000 per kilometer.

The analysis compared three options for connection and network cost pricing, as shown in Table 2.4. The analysis assumes that the transmission connection cost is incurred only in the first year (up-front payment), whereas the transmission usage cost is incurred every year for the lifetime of the wind farm, which is assumed to be 20 years.

As illustrated in Figure 2.4, the highest LCOE scenario occurs when the connection costs of the transformer and the connection line are included (option B), along with the transmission usage cost based on the flow-based method (option B). The lowest-cost scenario occurs when the transmission connection cost is considered zero cost by incorporating super-shallow policy (option C) and the generators are not allocated

**Table 2.3: Connection Cost and UoS Pricing Summary by Country/Region**

Country/ region	Connection cost allocation policy	Network pricing policy	Locational or nonlocational (zonal or nodal)	Transmission pricing cost allocation (%)	
				Generator	Load
Spain	Shallow policy <sup>b</sup>	Postage stamp <sup>f</sup>	Nonlocational—n.a. <sup>b</sup>	0 <sup>b</sup>	100 <sup>b</sup>
Germany	Shallow policy <sup>b</sup>	Postage stamp <sup>b</sup>	Nonlocational—n.a. <sup>a</sup>	0 <sup>a</sup>	100 <sup>a</sup>
Denmark	Shallow policy <sup>f</sup>	Postage stamp <sup>f</sup>	Nonlocational—n.a. <sup>c</sup>	2–5 <sup>c</sup>	98–95 <sup>c</sup>
United Kingdom	Super-shallow policy <sup>e</sup>	Hybrid <sup>e</sup>	Locational—Zonal <sup>a</sup>	27 <sup>a</sup>	73 <sup>a</sup>
Texas	Semi-shallow policy <sup>e</sup>	Hybrid <sup>e</sup>	Locational—Nodal <sup>a</sup>	0 <sup>a</sup>	100 <sup>c</sup>
Mexico	Deep policy	Hybrid	Two-voltage zones maximum	100	0
Panama	Semi-shallow policy	Usage flow-based	Locational—Zonal	70	30
Brazil	Shallow policy	Usage-flow-based	n.a.	100	0
Philippines	Semi-shallow policy	Postage stamp	n.a.	50	50

Sources: a. Wilks and Bradbury 2010. b. CEPA 2011. c. ENTSO-E Working Group Economic Framework 2010. d. López and Ackermann 2008. e. Frontier Economics Ltd. 2009. f. Scott 2007. g. Farias 2010. h. Pérez-Arriaga, n.d.  
 Notes: (i) Spain—Network UoS charges are uniform nationally. (ii) Germany—UoS charges are postalized within each separate TSO region. (iii) United Kingdom—UoS Hybrid charges include Locational (zonal) plus Usage (flow-based). Additional Balancing Service UoS charges are applied and equally shared. (iv) Texas—UoS Hybrid charges include locational and postage stamp. The charges have recently shifted from zonal to nodal in the last quarter of 2010. (v) Mexico—UoS postage stamp-based charges only apply to wind farms, otherwise flow-based usage for nonrenewable energy. (vi) Panama—UoS charges do not apply for renewable generation <= 10 MW. (vii) Philippines—UoS postage stamp charges are determined based on megawatt-hours of consumption/generation. (viii) Brazil—Small scale renewables using the integrated network use Distance MW-mile UoS methodology. (ix) Philippines—Refers to existing UoS charges for any type of source main interconnected network. (x) New policies in the Philippines are under consideration. n.a. Not applicable.

**Figure 2.3: Transmission Infrastructure—Connecting a Wind Farm to an Existing Transmission Network**

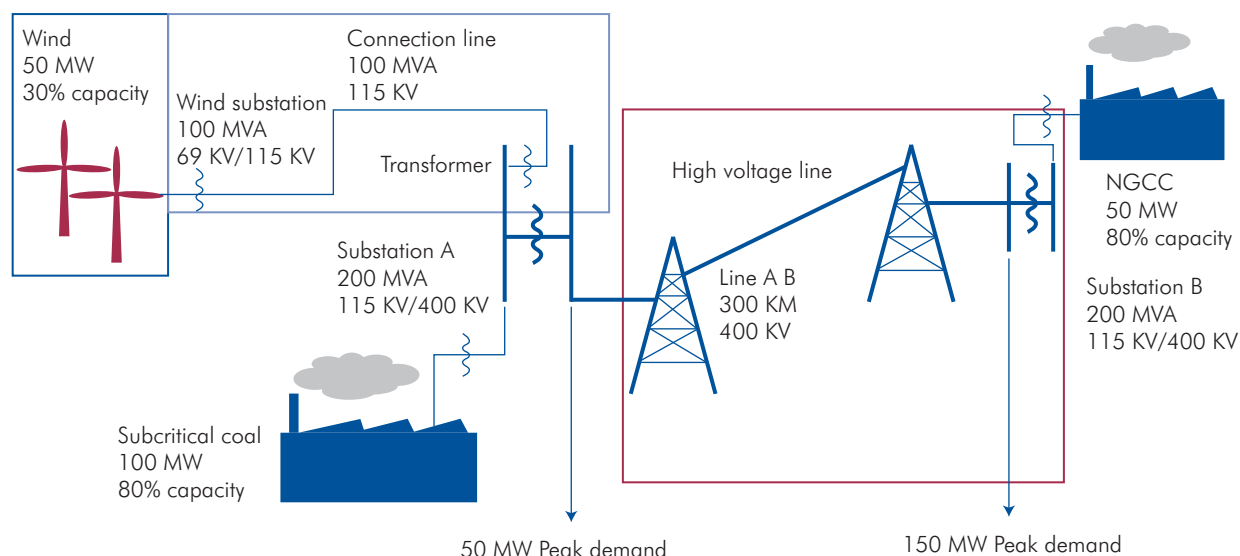

Source: The authors.

**Table 2.4: Transmission and Usage Cost Options**

Option	Transmission connection cost	Transmission usage cost
A	Deep connection policy: Includes costs of transformer, connection line from wind farm, and upgrade substation	Postage stamp-like, usage-based method
B	Shallower policy: Includes costs of transformer and connection line from wind farm	Flow-based method (average participation method)
C	Zero cost (super-shallow policy)	Zero cost (0% network cost to generation)

Source: The authors.

any network costs (option C). The difference in the LCOE between the highest- and lowest-cost scenarios is 15 percent. A 15 percent cost adder could easily consume, from the generator's perspective, a great part of an incentive for the production of renewable energy received by the generator.

This type of result is highly subject to the specifics of each situation—distance, voltage levels, existing network condition, and the composition of the other generation sources, as well as to the specific implementation details of the network pricing options. In fact, such variability is what leads to frequent disagreements when selecting

network pricing approaches. Not only that, there is no standard solution.

While the example is not a suggestion that pricing options that lead to lower costs are better, the example illustrates the importance of transmission costs in the economics of renewable energy. The following section will describe the great diversity of approaches that have been used to deal with cost allocation and pricing. In a broader context of achieving renewable energy policy objectives efficiently, Part II of the report will explain some general principles that specific pricing implementations should follow.

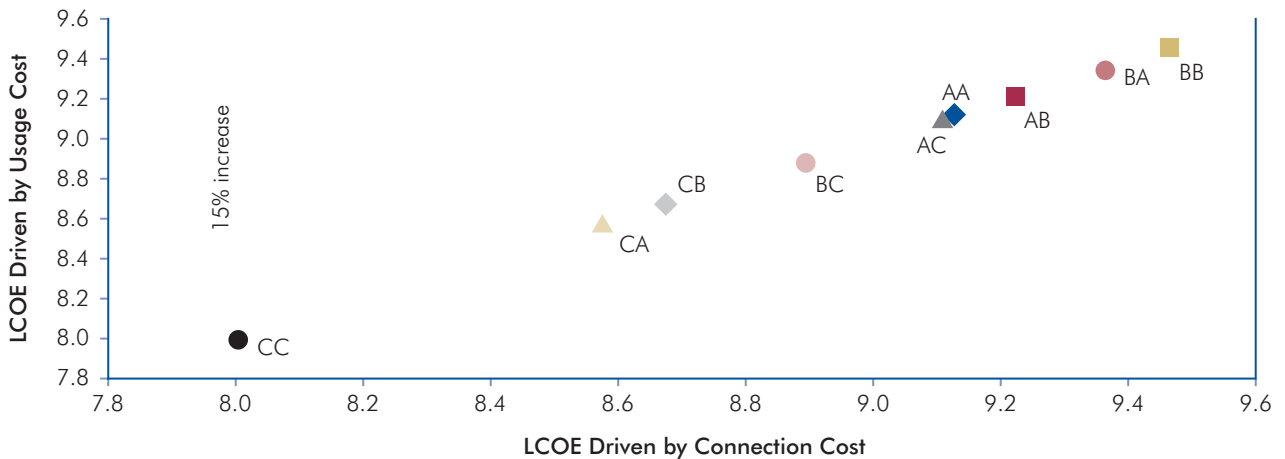
**Figure 2.4: LCOE Scenarios**

Source: Authors' calculations.

Note: AB means Connection cost option A and Usage cost option B.

### **3. PROACTIVE PLANNING AND OTHER INSTITUTIONAL ARRANGEMENTS TO EXPAND TRANSMISSION FOR RENEWABLE ENERGY**

#### **3.1. Summary**

The previous chapters described how scaling up renewable energy requires a considerable scaling-up of transmission investments. The chapters also described how different cost allocation and network pricing methodologies can impact the development of renewable generation. Emerging transmission pricing practices introduced to support the integration of renewable energy have also been described. These practices focus on reducing the cost of transmission burden faced by renewable energy providers. Besides network connection and UoS costs, there is another barrier to renewable energy associated with transmission. The barrier refers to costs associated with the interconnection-queue process. Traditionally, where the transmission sector has independent regulators or where a vertically integrated utility acts as the transmission counterpart, a renewable energy generator must request an interconnection.

The objective of the interconnection-queue process is to identify the needs that will be required to adequately and reliably interconnect the requesting generator. The investment needs determined in this process are used to establish what constitutes a connection or a network asset as described in the previous chapter. While the interconnection-queue process can work well for circumstances when just a few generation additions are made over a given year, the process can be highly challenged if large numbers of generators request interconnection. Scaling up renewable energy usually requires managing tens or hundreds of interconnection requests, which can clog the interconnection queue. This situation can lead to project delays and great burdens on human resources for the technical planning department of transmission companies. This chapter will describe how moving away from a queue of a “wait for request” strategy to a process where investment needs are identified “proactively” can greatly reduce the transaction cost to interconnecting generators. At the same time, planning proactively leads to a more timely delivery of the requisite transmission investments.

In addition to reducing waiting times, a proactive planning process can greatly reduce the transmission

investment needs required to integrate renewable energy. Using shallower connection cost policies and allocating little or no network costs to the renewable generator evidently helps renewable generation, but it does not ensure that transmission costs to consumers are minimized. In this chapter, we will present how better transmission planning practices can help reduce the transmission investment needs to connect renewable energy. New proactive transmission planning processes are emerging, which combine new open and participative process and improved analytical tools to make the connection process more time effective and in turn reduce transmission costs to both generation and demand.

The chapter will first describe some of the specific planning solutions implemented in different countries to address the timely and cost-effective extension of networks for renewable energy. Second, the chapter describes new analytical tools that are increasingly useful in transmission planning for renewable energy. Finally, the chapter also presents some concepts on transmission planning in general that are required to illustrate the above concepts.

#### **3.2. Proactive Planning Practices and New Institutional Arrangements**

Transmission investments needs have historically been driven by the increase in electricity demand and the reliability criteria used in the planning process. Geography (topology and location) has always been a factor that greatly affects transmission. For instance, the development of large hydropower complexes in remote locations has historically required huge transmission investment needs. At the same time, the location of the primary consumption centers and fossil fuel import or production locations has always been an important driver of transmission needs. Tapping into large amount of newer renewable sources, such as wind and solar power, requires bringing transmission services to multiple dispersed locations. As described in Chapter 1, tapping into these sources warrants considerable increases in the investment needs of transmission. However, as evidenced by country and regional experiences shared in this chapter, if the planning for transmission is organized to collectively and proactively address the needs of different generators, transmission costs can be reduced and the effectiveness of the process to develop the requisite transmission can be greatly improved. The following sections share examples

of varying planning practices adopted by different countries/regions.

### 3.2.1. Brazil

Brazil offers one of the world's cleanest energy mixes with 85.3 percent of overall energy production derived from renewable sources, including hydropower. In the last five years, biomass, small hydropower (SH), and wind energy have entered the renewable energy mix and significantly increased their share because of shorter construction times, the need for smaller investments, and lower overall investment risk. In fact, Brazil is the world's largest producer of sugar and ethanol. One of the most promising sites for renewables in Brazil is the Center-West region, which includes parts of the states of Mato Grosso do Sul and Goiás. As shown in the Figure 3.1, hundreds of candidate bagasse cogeneration and SH projects are spread over 200,000 square kilometers. However, because of their dispersed and remote locations away from the existing grid, integrating these small renewables has brought some challenges to existing transmission planning and regulatory practices.

From the procedural standpoint, Empresa de Pesquisa Energética (EPE)—the government planning agency—has no mandate to plan distribution level investments. By the same token, both the EPE and the distribution companies in the zone where transmission services had been required, lacked the personnel capacity to plan network expansion. In certain cases, the need

for transmission for the requesting renewable energy providers was greater, in terms of size and capital cost, than the current distribution network managed by many distribution companies in the area. To circumvent the human resource capacity challenge, the renewable developers were held responsible for preparing a transmission plan to interconnect all developers to the existing networks. The plan is elaborated under technical specifications provided by the EPE, which authorizes the plan prior to submission and approval of the electricity regulatory agency ANEEL. By allowing the generators to take the lead on network planning, the EPE and distribution companies are able to ease their capacity burden, yet regulators are able to keep control and provide oversight on transmission network expansion and upgrades. Additionally, by participating in the planning process, all costs associated with transmission are known by the generators. This is crucial, since renewable energy developers contract their energy output in a government-run energy auction. Winners of the auction receive a long-term energy purchase contract. By knowing the costs ahead of time, generators can safely bid in the auction and ensure a sufficient return on their investment. The entire process of planning, allocating costs, and developing the transmission network is built around the energy auction process.

The process is similar to the Open Season Process implemented in Mexico discussed in the Chapter 3 section, Mexico. However, in the case of Brazil, the generators are competing to sell their energy to an

**Figure 3.1: Location of Bagasse Cogeneration and SH Plants (left), Renewable Candidate Projects in Mato Grosso do Sul (right)**





auction, and the resulting transmission needs are developed by a new transmission company following a competitive procurement mechanism. Figure 3.2 highlights the Competitive Process to Develop Shared Transmission Networks (CPDST) for Renewable Energy adopted in Brazil.

From a high-level overview, renewable developers interested in developing generation within a particular region prepare a technical plan that is supervised and approved by the EPE. Once finalized, these plans are submitted to ANEEL for review and approval. Renewable generators express their intent to pay for the connection costs and network prices that result from the shared network. ANEEL is responsible for reviewing and ensuring regulatory compliance for all submissions. If approved, the renewable developers turn toward the energy auction market where they compete to win the energy contracts. At this point, the renewable developers are aware of the transmission connection costs and UoS charges they will incur from the shared transmission networks. Winners in the energy auction reaffirm their need for transmission services, at which time the final shared transmission network is designed to include any

potential changes derived from more or less interested interconnecting parties after the energy auction.

Once the final shared transmission network is defined and approved, ANEEL initiates a competitive bidding process to select a new transmission owner to finance and maintain the shared transmission network utilized by the renewable energy developers. Similar to the process used for the expansion of the main transmission system, the bid is awarded to the participant that requires the lowest allowed annual revenues to develop and maintain the line. The winner receives a transmission concession for a period of 30 years. The allowed revenue (resulting from the bidding process) is fixed for the first 15 years and reduced by 50 percent for the remaining 15 years. The revenues for the transmission concessionaire are derived from network charges applied only to the renewable generators connected to the shared network as described in the Chapter 2 section, Overview Network Infrastructure Pricing Methodologies.

An energy auction in Brazil, similar to the development of the shared networks based on the above described

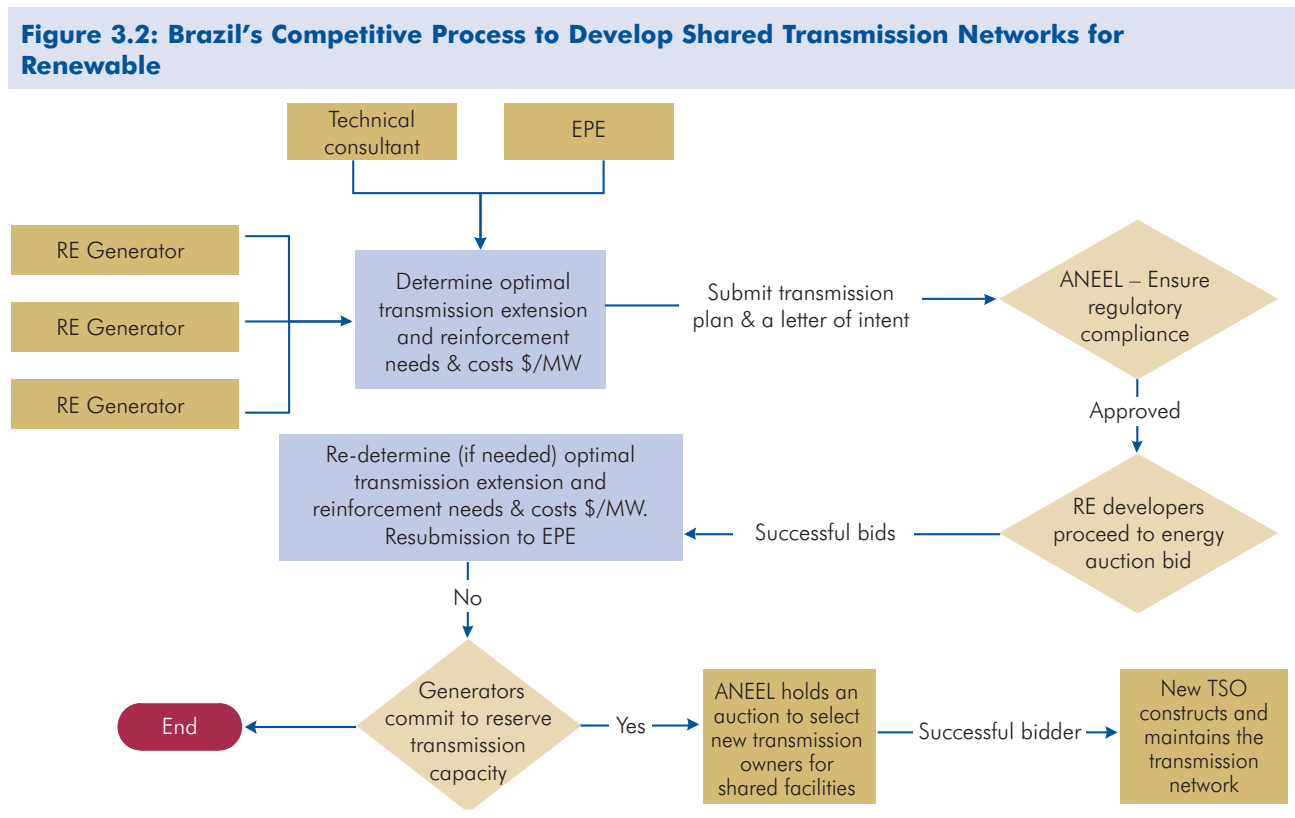

Source: Prepared by the authors.

process, is triggered on an as-needed basis. The CPDST process not only helped develop transmission needs that were outside the scope of existing regulations (regulatory “void”) or institutional capacities of existing distribution utilities, but it also helped create certainty for renewable energy developers about the process that should be followed to fulfill their needs.

The process also has important implications for minimizing infrastructure and operational costs needs, including system losses. By developing shared networks, whose development requires an organized process, renewable generators can greatly reduce connection costs by sharing the integration network costs.

Using an anticipatory approach to plan an integrated network eliminates the need to develop individual connections exclusively for each renewable generator to the high-voltage grid and also reduces the higher costs associated with such exclusive connections. Generators are responsible for bearing the enabling facilities and system extension cost to the shared network. The shared network, which makes for the bulk of the costs, is allocated among all the renewable generators sharing the facilities based on distance MW-mile methodology, as described in the Chapter 2 section, Overview Network Infrastructure Pricing Methodologies.

In addition to reducing overall transmission costs, the existing model in Brazil, which awards new transmission concessions using a competitive scheme, has been extended to the shared facilities to reduce the burden of up-front costs from renewable energy developers. The procurement process helps reveal the efficient cost of delivering such infrastructure, and private sector participation is attracted.

### 3.2.2. The Philippines

The Philippines, as mentioned earlier, has tremendous potential for renewable energy sources, and the enactment of the Renewable Energy Act (Congress of the Philippines 2008) provides an institutional framework and general guidance to foster the development and utilization of renewable energy. Advancing the development of transmission networks to connect the renewable energy potential would represent an important challenge, for which the act made some specific provision, as was discussed in the Chapter 1 section, The Need for Scaling up Transmission When Scaling up Renewable Energy.

The consideration in the act and in the implementing rules and regulations touches on three important subjects related to the development of transmission for renewable energy: first, the need to make sure these connections are considered and planned for by the transmission company (TRANSCO); the need to price transmission services for variable renewable energy on a per-megawatt-hour basis; and last, recognition that cost recovery of interconnection plays a major role in the economic viability of remotely located generation projects. All these provisions are being designed in detail at the same time the main support scheme, feed-in tariffs for renewable energy, are being designed.

In addition to the Renewable Energy Act, the National Renewable Energy Board (NREB), the Energy Regulatory Commission (ERC) in the Philippines, and the transmission company formed a technical group to address the aspects of planning for renewable energy. The objective of this group is to organize and plan the development of transmission based on interconnection requests for different zones where service contracts for renewable energy have been awarded. Such planning is aimed not only to reduce the inefficiencies in the process of interconnection requests, but also to reduce the significant transmission investment needs triggered by renewable generation.

A comparative case study assessing the transmission connection impacts for renewable energy in Luzon Island using the traditional reactive (wait-for-connection-request) approach against anticipatory planning, which was conducted recently by the World Bank. The objective of this study was to obtain an indicative quantitative assessment to compare the impact of the two planning approaches. Anticipatory planning would systematically look at given regions where the private sector has expressed interest in developing renewable energy sites. For each of these regions, a special planning model identifies minimum-cost transmission networks that can deliver transmission services to a group of projects rather than serving individual projects.

A summary of the results of the approach is provided in Table 3.1. Although in all subsystems, the net present value (NPV) of total transmission connection costs is similar or lower in the anticipatory planning approach, the impact varies depending on the characteristics of each subsystem. Average reductions in each subsystem range from about US\$3,000 per installed megawatt (La Trinidad Subsystem) to about US\$247,000 per installed

megawatt (Tuguegarao Subsystem). There is an average reduction in NPV of total connection costs for the area around US\$37,000 per installed megawatt, calculated by dividing the total reduction of US\$22 million in the total NPV by total installed capacity of 589.4 MW. While the

investment costs are based on traditional capital costs for transmission costs in other regions, the results highlight the importance of the planning approach. The proactive planning approach leads to overall improvements to most of the renewable projects' internal rates of return (IRRs),

**Table 3.1: Summary of Results—NPV of Total Costs and IRR**

Renewable energy project		NPV, total costs [kUS\$]		IRR [% p.a.]	
Subsystem	Name	Reactive	Proactive	Reactive	Proactive
Tuguegarao	TAREC 2	23,671	22,128	6.1	6.3
	TAREC 4	16,898	9,684	2.6	5.5
	DUMMON	7,964	1,831	1.2	4.7
	PINACAN	7,692	5,546	3.4	4.1
	ALL PROJECTS	56,225	39,189	—	—
Mexico	SWEET CRYSTAL	4,547	4,737	3.5	3.3
	BASECOM	3,624	3,181	4.1	4.7
	BATAAN 2020	5,744	5,744	8.7	8.7
	ALL PROJECTS	13,914	13,661	—	—
Laoag	PAGUDPUD	11,129	12,260	8.6	8.3
	BURGOS	10,967	10,575	9.5	9.6
	ENERGY LOGICS	10,725	8,636	9.9	10.1
	ALL PROJECTS	32,821	31,471	—	—
Bacnotan	SABANGAN	14,028	12,675	4.4	4.5
	LOMBOY/SUYOC	5,994	5,848	3.9	4.0
	LON—OU	19,635	18,789	4.8	4.8
	MAN-ASOK	3,663	3,080	0.6	1.3
	SAN GABRIEL	2,838	2,846	3.1	3.0
	ALL PROJECTS	46,158	43,239	—	—
La Trinidad	AMPOHAW	4,781	4,778	5.0	5.0
	KAPANGAN	13,865	13,865	4.8	4.8
	OMINONG	2,802	1,792	2.9	3.9
	EDDET	3,586	4,238	4.0	3.7
	KABAYAN	13,972	13,972	4.4	4.4
	BINENG	3,616	3,614	5.0	5.0
	ALL PROJECTS	42,622	42,260	—	—
	ALL SUBSYSTEMS	191,739	169,820	—	—

Source: World Bank 2010.

Note: Results intent to compare reactive vs. proactive approach using cost assumptions, resource quality, and financial parameters by the authors. Results should not be read as expected project's financial performance, which will depend on each project terms and conditions.

except for a few projects (Sweet Crystal, Pagudpud, San Gabriel, and Eddet). In some regions, cost reductions are considerable. Take, for instance, the Tuguegarao region, where the total cost of transmission was reduced by more than half and indicative IRR almost doubled.

The difference between the reactive transmission plan and the anticipatory transmission plan for the Tuguegarao region can be appreciated in Figure 3.3. The left side displays the transmission network layout connecting each of the four projects individually (reactively), and the right side presents the transmission network that results from the anticipatory planning process. More details of this case can be found in the Madrigal and others (2010).

Currently in the Philippines, the costs of transmission are borne by the developers. However, there are mechanisms by which the transmission company can finance and build the interconnections and recoup the investment through monthly installments from the generators. Such mechanisms ease the upfront investment burden on the renewable developers and encourage growth. Furthermore, the NREB is working on defining the draft regulation to establish feed-in tariffs for renewable energy providers that may

include incentives for transmission connection costs. This regulation is still under consideration, although incorporating such a policy, along with the proactive planning currently utilized, can significantly reduce the interconnection investment costs for renewable generation and further facilitate its growth.

### 3.2.3. Mexico

The government of Mexico, under the National Energy Strategy, has established a target of reaching 35 percent of the nation's energy mix from renewables. As mentioned in the Chapter 1 section, The Need for Scaling up Transmission When Scaling up Renewable Energy, one of the richest wind resource areas in Mexico is located in southeastern state of Oaxaca. The area has long been named La Ventosa, with estimated wind power potential between 5,000 MW and 6,000 MW with capacity factors of up to 40 percent. Approximately 2,745 MW of wind power capacity projects are estimated to be online by 2014. The majority of these projects, approximately 1,967 MW, will be owned and operated by the private sector to supply industrial consumers at privately negotiated energy prices—hence, this is considered nonpublic service demand. However, La Ventosa is located away from the consumption

**Figure 3.3: Reactive vs. Anticipatory Transmission Plan to Connect Renewable Energy Sites**

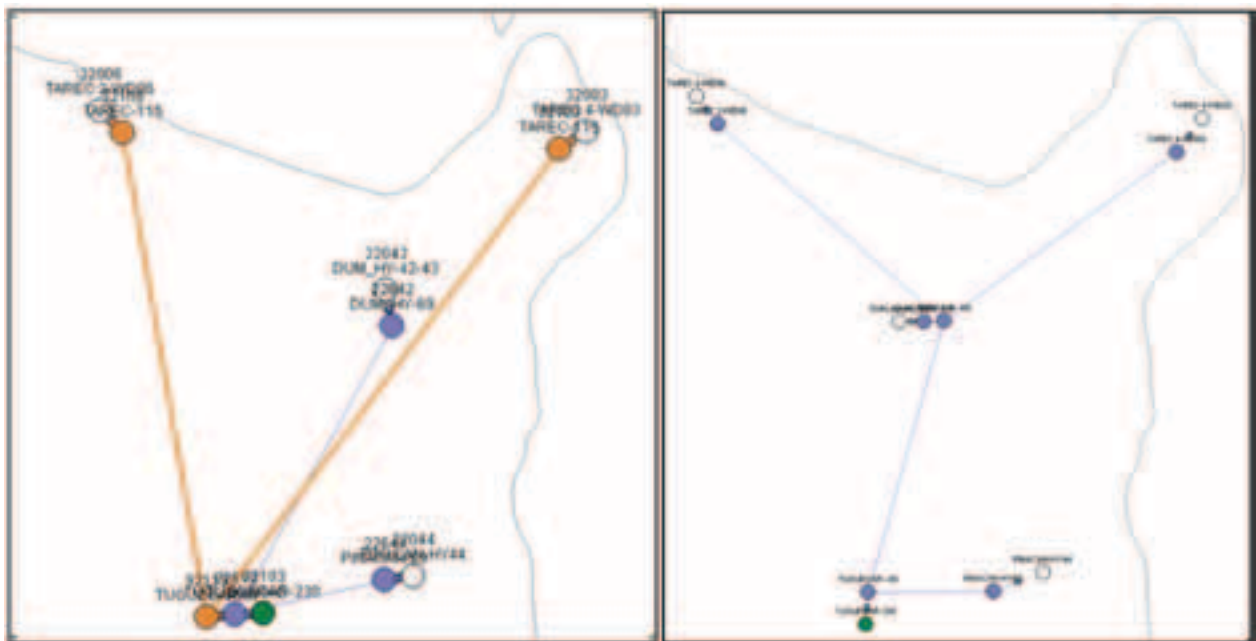

Source: World Bank 2010.

Note: green = 230 kV; orange = 115 kV; blue = 69 kV; dark gray = 34.5 kV; light gray = 11 kV.

centers and requires approximately US\$260 million in transmission network expansion and upgrade costs to connect these wind farms.

Mexico follows a deep connection policy whereby generators are responsible for all transmission connection costs, including reinforcement. Additionally, the CFE—a vertically integrated, state-owned utility—owns and operates the entire transmission network in the country and currently has no legal responsibility to expand its networks, including reinforcement, for generation projects that will not be supplying public service demand.

This creates a regulatory void, whereby neither party—neither renewable generators nor the CFE—can move forward unless the other party can guarantee its commitment. On one hand, generators are not able to secure the required financing until there is a commitment from the CFE that sufficient transmission infrastructure will be developed to accommodate their generation. On the other hand, the CFE requires generators to commit prior to commissioning the construction of any transmission expansion. This is commonly known as the chicken and egg dilemma.

To resolve this dilemma, Mexico, similar to Brazil's CPDST process, implemented an Open Season Transmission Planning Process. The process, mandated by the Ministry of Energy, is managed by the regulator (CRE) and triggered on an as-needed basis. The entire process from start to finish takes approximately six months to complete and thus far, the process has been carried out twice solely for the La Ventosa region. The objective of Open Season Process is (a) to identify the transmission investment needs to serve all wind power projects in the Ventosa region, (b) to determine the best minimum-cost expansion strategy for such needs, and (c) to define the cost-sharing ratio or firm transmission rights price for wind developers. The introduction of the Open Season has been seen as one of the major breakthroughs that had led to the financial closure and commitment of several wind power generation projects in the area. By 2010, 2,745 MW of wind power projects will be in operation in La Ventosa region (see Figure 3.4).

The first step in the Open Season consists of a period in which all interested renewable generators within La Ventosa region must express their interest in entering into a firm transmission service agreement with the utility (see Figure 3.5). Generators specify their location within the

**Figure 3.4: Wind Power Capacity in Operation in La Ventosa Region**

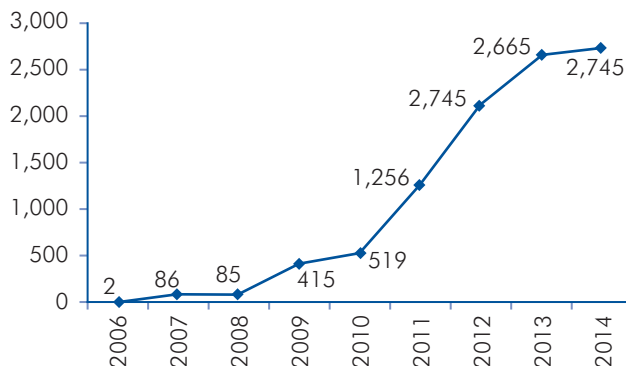

Source: CFE 2010.

Note: All projects are committed or under construction.

zone, size, and expected time to enter into operation, as well as other relevant technical information. Once this period is over, all project proposals are taken into account by the CFE, which performs the technical planning studies to determine the lowest-cost transmission network to serve all generators that have expressed interest. Once the transmission network is defined, the price of the firm transmission services agreement is determined by dividing the total cost by generation capacity in megawatts of all generators to be served by the network. Such prices and infrastructure development plans are shared with all involved parties. If renewable developers are interested in moving forward with their development plans after reviewing the costs, they must submit a letter of commitment to the CFE, along with a payment of 5 percent of the total costs to enter into the firm transmission service agreement.

Once the letter of commitment reserving firm transmission capacity is received by the CFE along with the 5 percent payment, the CFE includes the network expansion and upgrade in the official budget and overall investment planning of the utility. If at any time during the process a renewable developer backs out its commitment, the CFE must re-evaluate the transmission extension, along with the needs and associated costs, and communicate these changes with all parties. If no changes are necessary or if developers accepted all changes, developers are required to submit 25 percent of the payment related to their transmission service contract (investment costs) once the shared network appears in the official government budget that approved the utility

**Figure 3.5: Transmission Planning Open Season Process—Mexico**

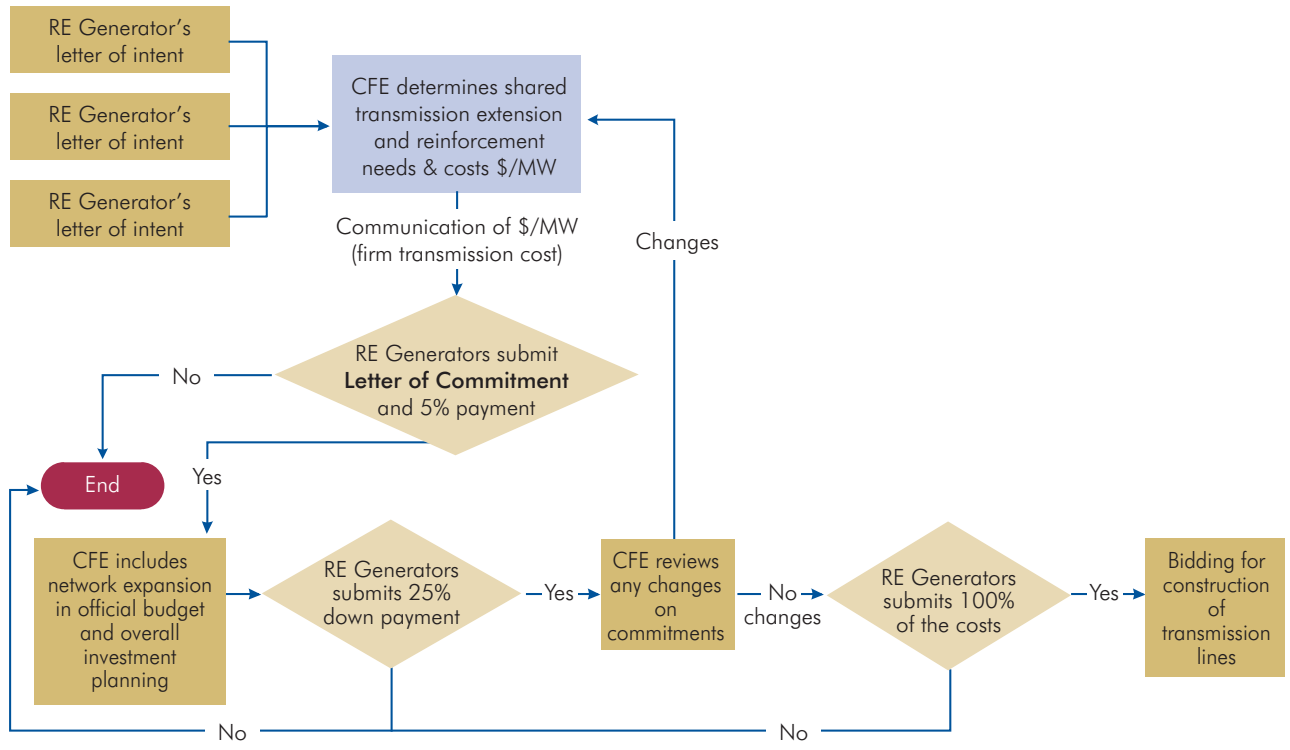

Source: Prepared by the authors with data from the CFE and CRE.

investments. Once the budget has been officially published, the utility starts the preparatory work to bid out for the construction of the transmission facilities. A month prior to the bidding, wind power producers commit fully by submitting 100 percent of their shared costs and signing the firm transmission services agreement with the CFE.

Both Brazil and Mexico follow an anticipatory approach to planning transmission. However, it is important to emphasize that, unlike Brazil, the renewable developers contract their energy sales directly with industrial consumers (self-supply) and do not participate in an energy auction. Additionally, investment costs of the shared network are paid upfront by renewable energy developers. The costs are shared on a per-megawatt basis and are due along the way through the Open Season Process with full payment due before the bidding process for construction of the transmission lines starts. This is the first time large investment needs

for the transmission system have been developed with the participation of the private sector. This is supported under an existing regulation of general application to all sectors, which allows for public and private sector participation in developing projects with productive uses. The CFE owns and operates the transmission lines, while the renewable energy developers pay for firm transmission service agreements that are necessary to finance the infrastructure. At the conclusion of the process, which has been launched twice up to 2010, a total of 1,927 MW of wind power generation projects have committed to sharing the cost of the transmission infrastructure that was identified by the CFE as necessary for all projects. Out of the 1,927 MW, 406 MW will be owned and operated by the utility, and the majority, 1,521 MW, will be owned and operated by the private sector under the scheme of self-supply.<sup>4</sup> Figure 3.6 presents high-level details of the transmission infrastructure that will be built as a result of the Open Season.

<sup>4</sup> Self-supply is a form of private participation in the generation sector in Mexico, by which a group of consumers implement a generation project to exclusively supply their consumption needs. Generation cannot be sold to third parties or the utility.

**Figure 3.6: Transmission Infrastructure to Connect RE as Result of the Open Season**

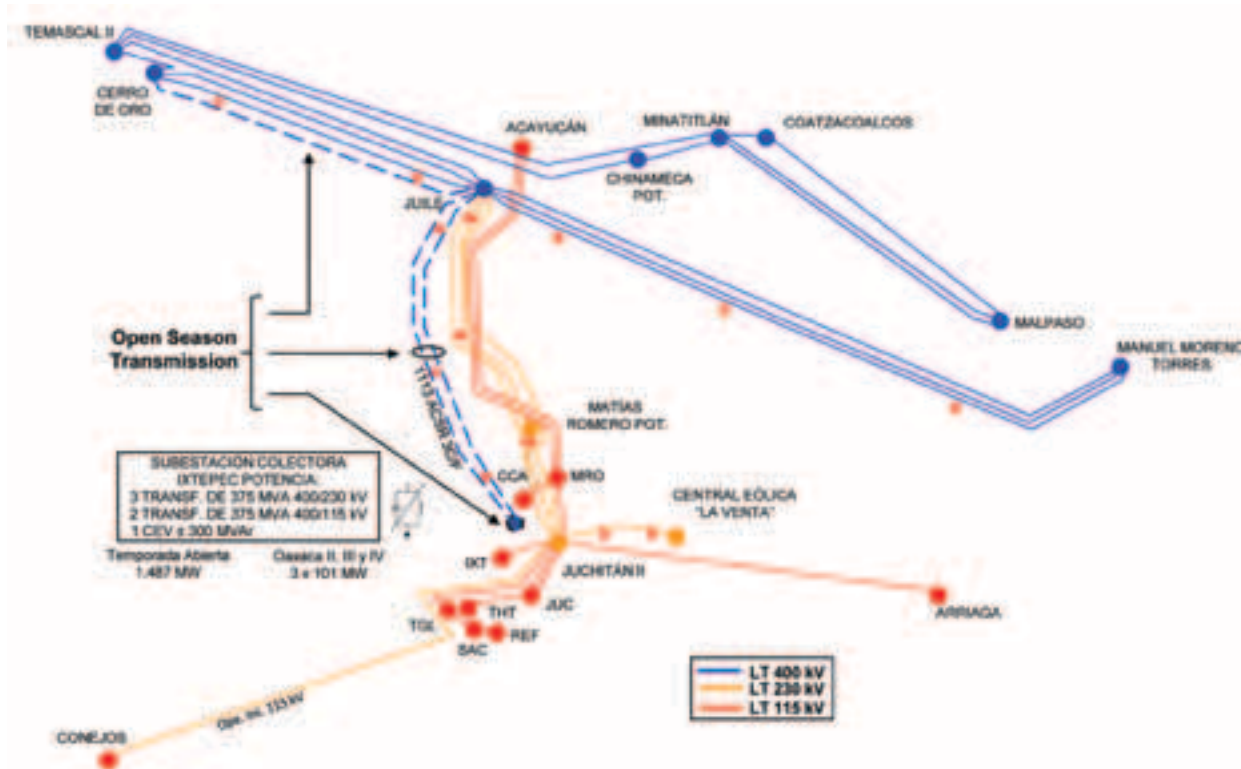

Source: CFE 2010.

Note: Transmission open season infrastructure is indicated by dashed lines.

### 3.2.4. The United Kingdom

As mentioned in the Chapter 1 section, The Need for Scaling up Transmission When Scaling up Renewable Energy, the Renewables Obligation mechanism has been the main driver behind the growth of renewable energy in the United Kingdom for past 20 years. In the United Kingdom, under the existing framework, the regulator assesses the transmission expansion plan and issues the final decision on the allowed capital and operation expenditures for the transmission utilities for a period of five years. These expenditures are recouped by transmission utilities by applying transmission charges to network users. However, because of the significant increase in renewable generation from RO mechanisms, investment needs in transmission and distribution have drastically increased. The higher investment needs specific to the United Kingdom are the result of interconnecting wind power generated in the north (Scotland) and bringing it to main consumption centers in the south. In fact, the capital expenditures approved

for 2006–12 period for the SPT tripled because of the higher investment needs needed for transmission network expansion resulting from increasing renewable generation.

As part of the decarbonization strategy in the United Kingdom and in Europe, the regulator entered into a lengthy process to review the existing regulatory models for energy networks (electricity and gas, transmission and distribution). The main driver of this review was to identify a new regulatory model to respond to the new context of the industry driven by the need for lower-carbon development. The review has led to two significant changes; first, the introduction of a procurement process for the development of offshore networks and, second, the approval of a new regulatory model for onshore transport energy networks that will apply starting in the year 2013. Each of these changes in are discussed in detail below. Another review is focusing on determining if changes to the connection and network cost allocation methodologies are required.

### 3.2.4.1. Offshore Networks Development

OFGEM and the Department of Climate Change established a new regulatory scheme to develop the transmission needs for offshore power development. The scheme seeks to ensure that new transmission networks for offshore renewable generation are developed efficiently and economically. The main feature of the scheme consists of granting transmission licenses to finance, build, and maintain networks to connect offshore development. The concessions will be awarded under a competitive procurement process to be conducted by the regulator. The procurement process is seen as a mechanism that encourages innovation, new sources of financing, and technical expertise to ultimately reduce costs for generators and consumers. Thus far, two rounds of procurement have commenced, although only Round One has concluded.

**Round One:** OFGEM commenced the first transitional round of bidding in June 2009. Transitional bids are for projects that have been or are being constructed by developers meeting certain preconditions. These are projects in the transitional regime, where the assets will be transferred to an offshore transmission owner (OFTO) upon completion of construction. Successful bidders were granted licenses in June 2010 (OFGEM n.d). Table 3.2 lists

**Table 3.2: Round One Projects—U.K. Transitional Procurement**

No.	Project name	Size (MW)	Completion date
1	Barrow	90	Operational
2	Robin Rigg East and West	180	Operational
3	Gunfleet Sands 1 and 2	164	Operational
4	Sheringham Shoal	315	April 2011
5	Ormonde	150	March 2011
6	Greater Gabbard	504	November 2010
7	Thanet	300	May 2010
8	Walney 1	178	October 2010
9	Walney 2	183	August 2011

Source: Compiled by the authors with data collected from the OFGEM website.

the projects, their size, and their completion date, which were included in Round One.

**Round Two:** OFGEM commenced the second transitional round of bidding on November 17, 2010. Unlike in Round One, transitional bids in Round Two are for projects where the transmission assets have been or will be constructed by the offshore developer, then transferred to the OFTO (OFGEM n.d). The decision on preferred OFTO for the projects in Round Two will be issued in July 2011. Table 3.3 list the projects and their size, as included in Round Two.

### 3.2.4.2. New Regulatory Model for Onshore Energy Networks

Traditionally, the U.K. transmission networks have been regulated by an incentive mechanism known as RPI-X. Under this process, capital and operational expenditures submitted by transmission owners are assessed by the regulators using several audits and technical studies to determine consumer tariffs on five years' duration. Once transmission companies respond to the assessment, the regulators release the final decision on the price control review. This review determines the capital and operational expenditures that are deemed necessary and efficient for the companies to provide their services. The RPI-X process has been conducted four times thus far, although the last regulatory period (2007–12) was extended until March 2013, when the regulation will take effect.

Regulators in the United Kingdom recognized the challenges faced by transmission and distribution networks driven by huge and rapidly growing investment needs. For instance, the expected investments in transmission and distribution networks are estimated to be £32 billion by 2020, which is nearly double the expenditures of the last 20 years. The new RIIO

**Table 3.3: Round Two Projects—U.K. Transitional Procurement**

No.	Project name	Size (MW)
1	Gwynt y Mor	576
2	Lincs	250
3	London Array Phase 1	630

Source: Compiled by the authors with data collected from OFGEM website.



model (revenue = incentives + innovation + outputs) has been designed specifically to meet the needs of delivering expanding networks required for the sustainable and low-carbon development of the power sector. The RIIO model will place more emphasis on the long term by first extending the regulatory review period from the traditional five-year to eight-year period and will first be implemented in 2013 to determine consumer tariffs for 2013–21 (OFGEM 2006). One of the main considerations of the new model is to make an up-front determination of revenue requirement by transmission operators to guarantee financial viability, timely delivery, focus on timely and efficiently delivery of services, transparency and predictability, and balancing costs paid by current and future consumers. The new model will be implemented by means of incentives, innovation, and transparency and predictability, and will balance the costs of existing and future consumers and provide clear definition of expected output.

In addition to the review of the regulatory model, OFGEM initiated a process to review the network pricing mechanisms for electricity and gas transmission networks. The review will assess whether existing connection and network pricing mechanisms, largely based on cost-causality measures, are adequate to facilitate a timely move to a low-carbon energy sector while providing safe, secure, and high-quality network services at a good value for the money for existing and future consumers. The process began in September 2010 and, after a first round of consultation, some priorities were identified. On interconnection cost pricing issue, the priority objective is to review the existing interconnection commitment arrangements between interconnecting generators and the network. The existing user comments arrangement describes the amount of guarantees that interconnecting generations should provide from the time they request interconnection to the time the facilities of individual are commissioned for construction.

The objective of the guarantee scheme is to protect transmission operators from incurred costs in case the interconnecting generator withdraws (OFGEM 2010b). The review process is focused on ensuring that the risks between new and existing network users are balanced, as well as the risks between any user and the transmission companies. The objective is to ensure that excessive or inappropriate connection costs do not fall to consumers and they are transparent, proportionate, and nondiscriminatory, and do not act as a barrier to entry to any generator, including renewable energy.

The overall review will be guided by the principles of the new regulatory model, which is to encourage network companies to play a full role in the delivery of a sustainable energy sector and to deliver valuable network services for existing and future consumers (OFGEM 2011a). On network pricing, the review recognized that all options are still open, from eliminating the short-term locational component of transmission pricing, but improving the long-term location signal, to further improving the short-term locational signals in transmission prices (OFGEM 2011a).

### 3.2.5. Texas

As mentioned earlier, Texas currently not only leads the nation with 9,528 MW of installed wind power capacity (ERCOT 2011) and its success is partially attributed to the RPS. The RPS was first introduced in Texas as part of the state's electricity restructuring legislation in 1999 under Senate Bill 7 to ensure continuous growth in the renewable energy generation in Texas despite the increasing competitiveness in the electricity markets. The RPS in Texas mandated that electricity providers generate 2,000 MW of additional renewable energy by 2009. This 10-year target was met in just over 6 years and, in part because of its success, Senate Bill 20 was introduced in 2005. Senate Bill 20 increased the targets and mandated that the state's total renewable energy generation must reach 5,880 MW and 10,000 MW by 2015 and 2025 respectively. The bill also mandated that 500 MW of the 2025 renewable energy target be derived from nonwind sources. However, because of the relatively low cost and abundance of wind resources, wind power dominates renewable energy generation in Texas. By instituting the RPS, wind power development in Texas has more than quadrupled and, because of its competitive pricing, available federal tax incentives, and the state's immense wind resources, wind power is expected to remain competitive with coal- and gas-fired plants (SECO 2011).

Introduction of the RPS has led to concentrated efforts in developing wind farms, although inadequate transmission was cited as the most significant obstacle to development. Wind-endowed regions, such as around McCamey, Texas, which has a tremendous capacity to generate renewable energy, have been handicapped from the lack of transmission infrastructure. To further prevent such hindrances, and to respond to the tremendous transmission needs triggered by renewable generation, Texas has adopted proactive transmission planning (discussed later) as part of their legislative strategy.

In 2008, the PUC issued a final order designating five renewable wind energy zones and a transmission expansion strategy to transfer renewable energy from the zones to the load based on the most optimal and cost efficient way. This transmission expansion plan would interconnect 18,456 MW of wind power from West Texas and the Panhandle at the total project cost of approximately US\$7.8 billion. Table 3.4 summarizes the capacity, cost, and total distance for each competitive renewable energy zone (CREZ).

Senate Bill 20 laid the groundwork for large transmission lines in order to accommodate present wind industry needs and to further accelerate the use of wind power in the state. The bill requires that CREZs be designated in the best wind energy resource areas in the state and that an electric transmission infrastructure be constructed to move renewable energy from those zones to markets where people use energy (SECO 2011).

A CREZ is meant to get transmission out to prime wind energy areas before wind farms have even been developed. This overall CREZ process is managed and regulated by the PUC and follows the procedures described below and pictorially defined in Figure 3.7 (PUC 2009b):

- **Designation of CREZs:** In the initial step, the PUC initiated a contested case hearing that allowed any interested entity to nominate a region for CREZ designation. Simultaneously, the Electric Reliability Council of Texas (ERCOT) initiated a wind study, commissioned by the PUC, detailing wind energy production capacity statewide in conjunction with the transmission constraints that are most likely to limit the deliverability of electricity from wind energy resources. The report is prepared in consultation with independent system operators (ISOs), regional transmission organizations (RTOs), utilities, and other independent organizations, and also includes analysis of wildlife habitats that may be affected by renewable energy development in any candidate zone provided by the Texas Department of Parks and Wildlife. Within six months of the report submission, the PUC issues a final order designating a CREZ. For each CREZ designated, the PUC must also specify (a) the geographic extent of the CREZ, (b) the major transmission improvements needed to deliver the renewable energy in a cost-effective manner, (c) an estimate of the maximum generating capacity of the region that transmission is expected to accommodate, and (d) other requirements included in the Public Utility Regulatory Act.
- **Level of financial commitment by generators for designating a CREZ:** Once the CREZs are designated, various documents that include pending or signed interconnection agreements for planned renewable energy resources, as well as leasing agreements with landowners in a proposed CREZ, are reviewed to determine the financial commitments of generators for the designated CREZ. In addition, financial commitments from investors to build transmission facilities dedicated to delivering the output or renewable energy in a proposed CREZ are also assessed.
- **Plan to develop transmission capacity:** After the level of financial commitment is assessed, the PUC is responsible for developing a plan for transmission

**Table 3.4: Texas Transmission Expansion Projections**

CREZ	Wind capacity (MW)	Total cost of project (US\$ million)	Total CREZ miles
Panhandle A	3191	833	523
Panhandle B	2393	444	258
Central West	1859	280	186
Central	3047	1,098	704
McCamey	1063	5,188	320
Base case capabilities*	6903	n.a.	n.a.
<b>Total</b>	<b>18,456</b>	<b>7,843</b>	<b>1,991</b>

Source: Compiled by the authors with data obtained from (PUCT-CREZ 2010) and Cross Texas Transmission. n.a. Not applicable.

Note: Base case: the generation capacity was either operational or had signed interconnection agreements.

**Figure 3.7: CREZ Process, Texas**

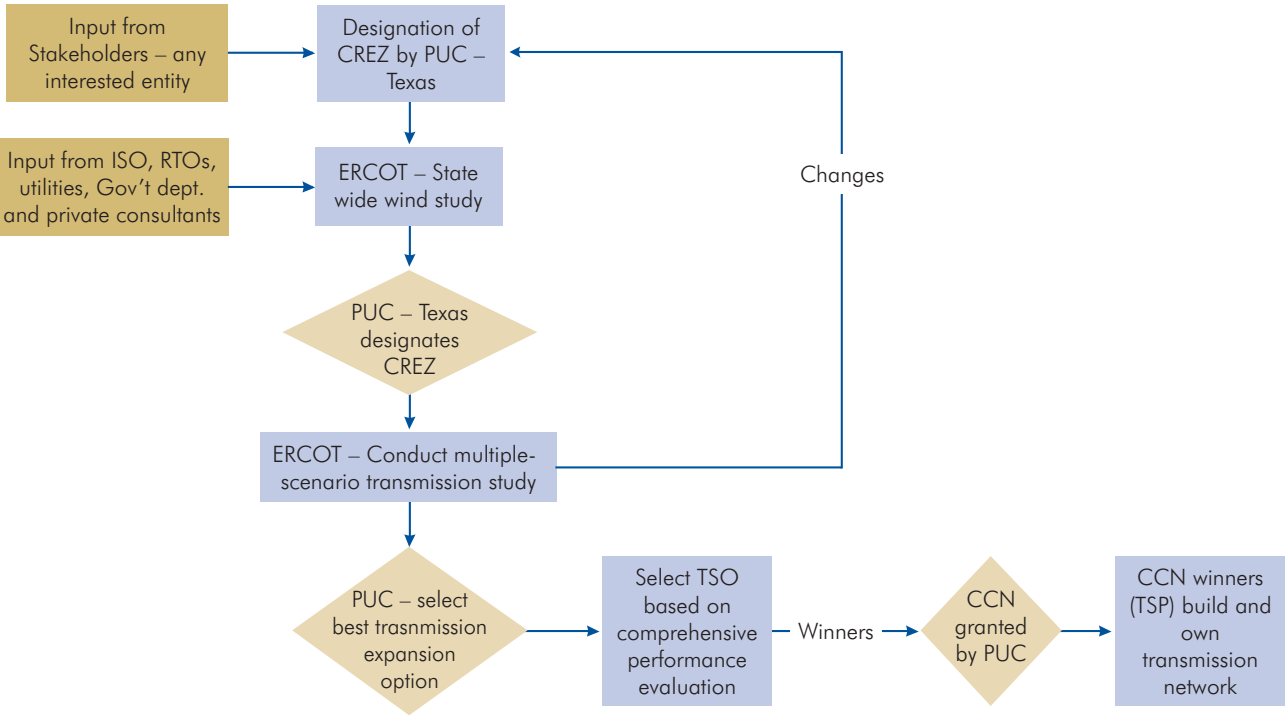

Source: Prepared by the authors.

networks that will accommodate renewable energy in the designated CREZ in a manner that will be most beneficial and cost effective to the customers. The PUC is also responsible for selecting one or more entities responsible for constructing and upgrading the transmission network. All parties interested in construction of transmission improvements are required to submit expressions of interest to the PUC after the issuance of final order.

- Certificates of convenience and necessity (CCNs):** One of the main features of a CREZ is a CCN. A CCN guarantees that all costs associated with building and maintaining the transmission network will pass through to consumers via tariffs. All (100 percent) of the transmission costs are passed on to the load. Hence, TSOs recover their investments through the postage stamp method from consumers (Diffen 2009). Each TSC selected to build and own transmission facilities for a CREZ is required to file a CCN application. Rule 25.216 in the Texas legislature dictates that incumbent utilities or owners will be responsible for the upgrades for all existing facilities, unless there is a good reason or owner’s request otherwise. Unlike in Brazil where TSOs are determined based on a

two-part, sealed-envelope bidding process, in Texas the TSOs are selected based on a comprehensive performance evaluation performed by the regulator. To further elaborate, Rule 25.216 states that in order to become a qualified TSC, the TSC must demonstrate that it is capable of building, operating, and maintaining the facility identified in the CREZ plan. The PUC will then select TSCs based on their ability to provide the needed CREZ transmission facility in the manner that is the most cost effective and beneficial to consumers (PUC 2009b). The decision factors include the “TSP’s [TSC’s] ability to finance, license, operate, and maintain facilities; the TSP’s [TSC’s] cost projections and proposed schedule; its use of historically underutilized businesses; and its track record and understanding of the project” (Diffen 2009). The PUC ensures sufficient financial commitment from renewable generators prior to granting the certificate of convenience and necessity to the TSC. TSCs may propose modifications to the transmission facilities at this time if those modifications can reduce cost or improve capacity for the CREZ. All modifications are reviewed by ERCOT based on the PUC’s directions. Approval by the PUC is

permitted through CCNs that grants permission to TSC to move forward with constructing the project and exercise the power of eminent domain where necessary (RS&H 2011). To protect the TSO or utilities responsible for building the transmission from developers backing out, the developers are required to post a deposit, which is returned when the generation plant is complete and ready for interconnection. In return, CCN guarantees TSOs that they will recoup their cost via a postage stamp method through consumer tariffs.

Although this process may seem similar to the anticipatory planning in the case of Brazil and Mexico, the differences are quite significant. Texas uses a proactive approach determined on the basis of RPS. The RPS sets the state's renewable energy targets and forces regulators to aggressively plan ahead in order to reach those targets within the set timeframe. As opposed to a reactive approach where transmission networks are extended in response to the request filed by the renewable developers or an anticipatory approach where the network is efficiently designed based on a specific region to exploit the immediate needs of investors, the regulators in Texas ambitiously plan cost-efficient transmission network strategy five years in advance. The transmission network expansion strategy is based on comprehensive research and stakeholder participation to determine the optimal renewable energy zones, which allows for maximum generation capacity and cost efficiency for consumers and transmission. Based on the process described above, the transmission network is extended to the designated CREZ prior to the development of renewable generation facilities to prevent delays and facilitate growth.

This proactive transmission planning approach has enjoyed phenomenal success in Texas. In response to this legislative action, the PUC issued a final order in Docket No. 33672 in 2008, establishing five CREZs in Texas and designating a number of transmission projects to be constructed to transmit wind power from the CREZs to the highly populated metropolitan areas of the state (RS&H 2011).

Initially, the study conducted by ERCOT presented the top 25 wind regions in the state based simply on the wind capacity factor and did not take into account the availability of transmission. The zones (displayed in Figure 3.8) are numbered according to wind generation

potential with Zone 1 having the strongest and zone 25 having the weakest wind resources (Diffen 2009). These sites were selected based on a complex meteorological and terrain model that provided localized prediction of wind patterns and resulting wind power output across the state (ERCOT 2006b).

Once the zones were identified, ERCOT developed several transmission plans to accommodate the zones with various transmission options. These data were used by the commissioners in the CREZ proceedings to help make well-informed decisions. During the legal proceedings, 65 parties intervened and more than 1,400 documents were filed, including financial commitment testimony to support more than 24,000 MW of CREZ projects across 16 zones. Because of the high volume of materials filed and the breadth of the issues presented during the hearings, the final order deadline was extended. However, an interim order was issued designating the five competitive zones for which various transmission options would be investigated to derive accurate cost estimates. From the initial 25 zones suggested by the study, 9 were eliminated because of no evidence filed, and 8 others demonstrated a lower level of financial commitment. The commissioned ensured that the remaining 8 zones displayed sufficient renewable energy resource and suitability for wind development. There also needed to be nonrenewable generation available to provide ancillary services, such as backing up the wind by ramping up as wind output decreases. And finally the PUC also factored in system reliability, environmental sensitivity, economics, and geographic diversity (Diffen 2009). These eight zones were combined to form the five CREZs identified in Figure 3.9.

Once the CREZs were designated, the PUC's interim final order outlined four scenarios for building transmission capacity for wind generation specified in the Table 3.5, depending on cost and the number of wind farms to be built. Table 3.5 summarizes the four scenarios.

After evaluating all four scenarios based on total and incremental cost, transmission system capacity, congestion, economies of scale, incremental costs, environmental benefits, and fuel cost savings, the PUC issued its order selecting Scenario 2 on October 7, 2008, with its associated transmission plan to interconnect 18,456 MW of wind power from West Texas and the Panhandle. The total cost of these projects is estimated to be approximately US\$7.8 billion

**Figure 3.8: Potential Wind Resources, Texas**



Source: Woodfin 2007.

related to new renewable generation technologies as summarized in Table 3.4.

Based on the April 11, 2011, quarterly CREZ progress report (PUC 2011), a number of the CREZ projects have been completed and others are in various stages of completion. Based on information provided by TSCs, the estimated schedule completion date for the last project is December 31, 2013, which is in alignment with the PUC's stated program completion goal of the close of 2013. However, many projects are still in the early stages of development, which can cause delays in the overall timeline. Additionally, the estimated cost of the CREZ program based on current reported data is US\$6.5 billion, a decrease from the initial estimate of US\$7.8 billion.

Texas legislature set ambitious renewable energy targets to RPS while simultaneously laying the necessary groundwork to enable proactive, planning which has resulted in tremendous success. The CREZ process

enables proactive planning, which includes stakeholder consultation, and it provides transparency, reduces cost, and ensures optimal network expansion benefitting TSOs, generators, and consumers.

### 3.2.6. Midwest ISO

The Midwest Independent Transmission System Operator, Inc. (Midwest ISO) is the first RTO approved by the Federal Energy Regulatory Commission (FERC). It serves as an independent, nonprofit organization responsible for the safe, cost-effective delivery of electric power. Midwest ISO provides unbiased grid management and reliable transmission of power in 13 states and the Canadian province of Manitoba.

With a massive footprint that covers 93,600 miles (920,000 square miles) of transmission with a combined market generation capacity of 138,556 MW, Midwest ISO manages one of the world's largest energy markets using security-constrained

**Figure 3.9: Texas CREZ Map**

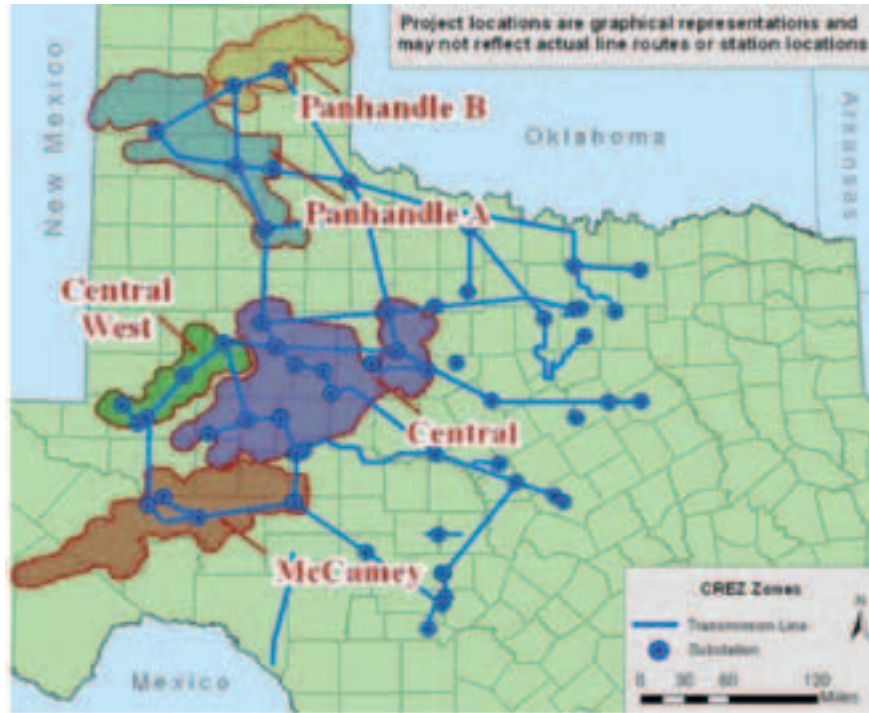

Source: PUC 2010.

economic dispatch of generation, clearing more than US\$23 billion in gross market charges annually. However, Midwest ISO does not generate or buy electricity. Nor does it own transmission; instead, it operates at a regional dimension and administers the market for electricity producers and users on a wholesale level and provides reliability to the electric grid. Besides its responsibility of operating the grid, the Midwest ISO facilitates value-based regional planning for reliable generation and transmission of

energy through its annual Transmission Expansion Planning. Furthermore, Midwest ISO also serves as the region’s balancing authority, providing oversight to 25 local balancing authorities, 26 TSOs, and 3 regulatory bodies. Figure 3.10 details the balancing authority alignment. This is a complicated task, since some transmission owners are vertically integrated and regulated by individual states, while others are independently owned and regulated by FERC. In addition, only a few states within the

**Table 3.5: Megawatt Tiers for ERCOT CREZ Transmission Optimization Study**

	Scenario 1 (MW)	Scenario 2 (MW)	Scenario 3 (MW)	Scenario 4 (MW)
Panhandle A	1,422	3,191	4,960	6,660
Panhandle B	1,067	2,393	3,270	0
McCamey	829	1,859	2,890	3,190
Central	1,358	3,047	4,735	5,615
Central West	474	1,063	1,651	2,051
CREZ Wind Capacity	5,150	11,553	17,956	17,516

Source: ERCOT 2008b.

**Figure 3.10: Balancing Authority Alignment**

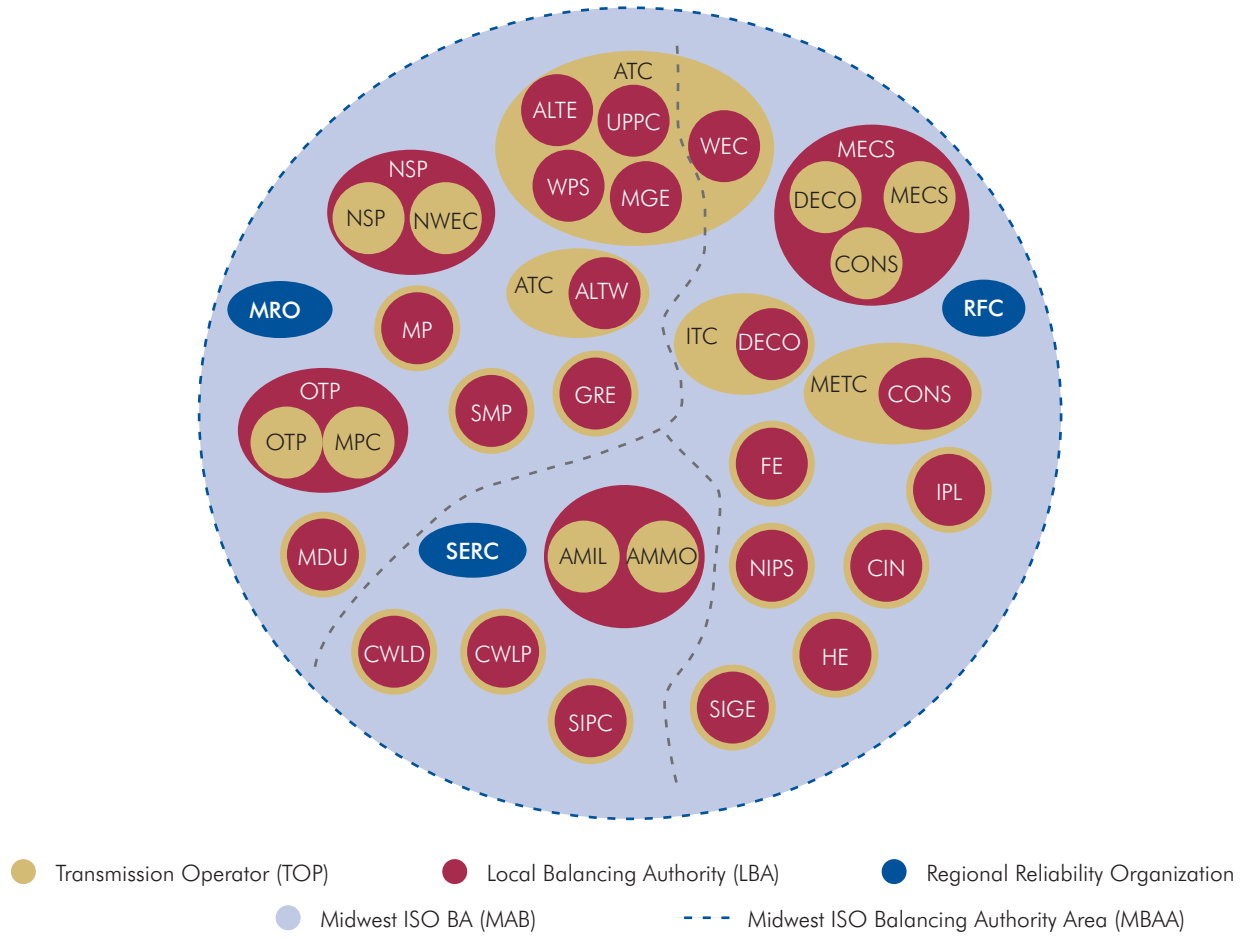

Source: Chatterjee 2010.

Midwest ISO offer retail choices, and each state has varying recovery mechanisms for new transmission investments.

In addition to the structural and operational differences in the energy market within each state, renewable energy targets established by individual states vary in specific requirements and implementation timing (Midwest ISO 2010c). This adds further complexity, since some states within the Midwest ISO purview—that is, Illinois, Iowa, Michigan, Minnesota, Missouri, Montana, Ohio, Pennsylvania, and Wisconsin—currently have RPS mandates. North Dakota and South Dakota do not have an RPS, but they do have renewable goals, while Indiana and Kentucky currently have neither RPS mandates nor goals (Midwest ISO 2010c). Figure 3.11 displays the RPS and renewable goals for individual states within the Midwest ISO.

Figure 3.12 summarizes the percentage of renewable energy requirements on yearly basis for respective states within the Midwest ISO.

Ambitious legislative renewable energy requirements or goals have been a significant driver for transmission expansion efforts led by Midwest ISO where the majority of the renewable energy requirements would be met through wind energy. To build the optimal transmission expansion plan that will offer the lowest delivered dollar per megawatt-hour cost, Midwest ISO, with the assistance of state regulators and industry stakeholders, conducted the Regional Generator Outlet Study (Midwest ISO 2010c).

The study evaluated 14 different renewable generation options, which included (a) only local generation, which requires less transmission to be delivered to load centers;

**Figure 3.11: RPS and Renewable Goals for Individual States**

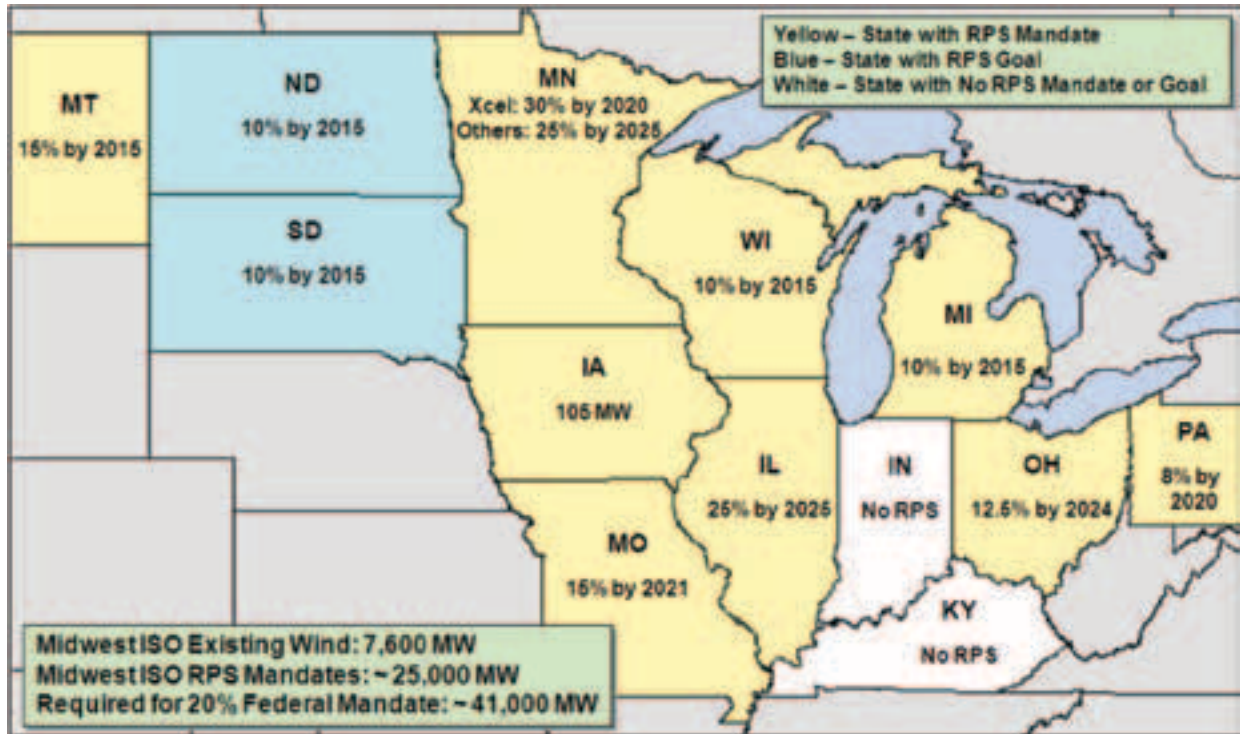

Source: Midwest ISO 2010c.

**Figure 3.12: RPS or Renewable Goals for Respective States within Midwest ISO**

Year	WI (% of energy)	MN (w.o Xcel) (% of energy)	MN (w.o Xcel) (% of energy)	IL (% of energy)	MI (% of energy)	OH (% of energy)	MO (% of energy)	MT (% of energy)	PA (% of energy)	SD (% of energy)	ND (% of energy)	IA (MW)
2015	10.00	12.00	18.00	10.00	10.00	3.50	5.00	15.00	5.50	10.00	10.00	105
2016	10.00	17.00	25.00	11.50	10.00	4.50	5.00	15.00	6.00	10.00	10.00	105
2017	10.00	17.00	25.00	13.00	10.00	5.50	5.00	15.00	6.50	10.00	10.00	105
2018	10.00	17.00	25.00	14.50	10.00	6.50	10.00	15.00	7.00	10.00	10.00	105
2019	10.00	17.00	25.00	16.00	10.00	7.50	10.00	15.00	7.50	10.00	10.00	105
2020	10.00	20.00	30.00	17.50	10.00	8.50	10.00	15.00	8.00	10.00	10.00	105
2021	10.00	20.00	30.00	19.00	10.00	9.50	15.00	15.00	8.00	10.00	10.00	105
2022	10.00	20.00	30.00	20.50	10.00	10.50	15.00	15.00	8.00	10.00	10.00	105
2023	10.00	20.00	30.00	22.00	10.00	11.50	15.00	15.00	8.00	10.00	10.00	105
2024	10.00	20.00	30.00	23.50	10.00	12.50	15.00	15.00	8.00	10.00	10.00	105
2025	10.00	25.00	30.00	25.00	10.00	12.50	15.00	15.00	8.00	10.00	10.00	105

Source: Midwest ISO 2010c.



**Figure 3.13: Total Generation and Transmission Cost for Each Option, Midwest ISO**

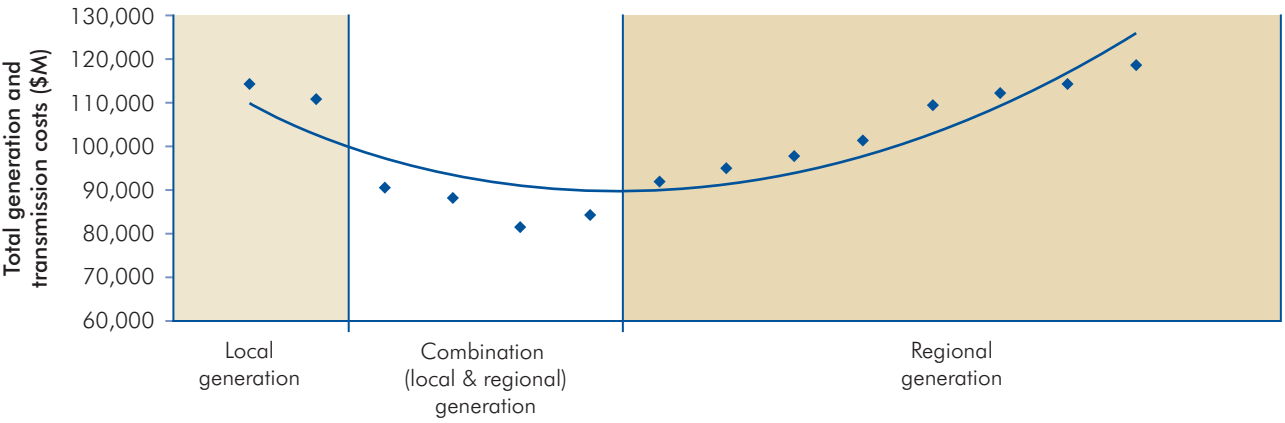

Source: Midwest ISO 2010c.

(b) only regional generation where generation is placed in the regions with the highest wind capacity; and (c) several combinations of local and regional generation. Transmission overlays were developed for each of the 14 scenarios in consultation with the transmission owners on a high-level, indicative basis. The graph in Figure 3.13 illustrates the capital cost of each of the 3 options. Based on the RGOS, it was determined that the least-cost approach to developing renewable generation and expanding the corresponding transmission network would be option 2 where a combination of local and regional wind generation locations. This approach was affirmed and endorsed by the Upper Midwest Transmission Development Initiative and the Midwest Governors Association (Midwest ISO 2010c).

The RGOS also narrowed its focus to the development of three transmission expansion scenarios that met respective state renewable energy targets by integrating wind from the designated zones: (a) Native Voltage: overlay that does not introduce new voltages in the

area; (b) 765 kV: overlay allowing the introduction of 765 kV transmission throughout the study footprint; and (c) Native Voltage with DC: transmission that allows for the expansion of direct current (DC) technology with the study footprint. Figure 3.14 provides the summary of transmission cost based on each transmission expansion option. These costs represented the comparative measure of total megawatt-hour cost if wind served as the only energy source relative to RGOS wind and transmission (Midwest ISO 2010c).

Based on the results indicated by the study, the optimal and most cost-efficient approach for the states to meet its renewable energy targets would be a combination of local and regional renewable energy generation efforts. These options represent a potential investment of US\$16–22 billion over the next 20 years and consist of new transmission mileage of 6,400–8,000 miles. Midwest ISO is leading the charge on coordination and development to achieve the renewable targets of all states within the region.

**Figure 3.14: Transmission Cost Based on Three Expansion Scenarios, Midwest ISO (US\$ millions)**

Category	Graphic purview	Native voltage	765 kV	Native DC
Transmission	<b>Total</b>	<b>\$1,686</b>	<b>\$2,064</b>	<b>\$2,188</b>
	Midwest ISO	\$1,419	\$1,537	\$1,304
	PJM	\$209	\$424	\$227
	Joint/DC*	\$57	\$102	\$656

Source: Midwest ISO 2010c.

Planning for these large investments and geographically diverse transmission portfolios is very different from the traditional planning driven by load growth. To tackle this challenge, Midwest ISO established a more comprehensive planning approach—Value Based Planning illustrated in Figure 3.15.

Through its stakeholders, Midwest ISO developed a strategy to decrease total system cost by combining generation deliverability, loss of load expectation, generation and future transmission costs, system economics, and market rules with existing and future policy needs. This strategy deals with complex questions by constructing a series of scenarios representing alternate futures that can be used by planners to design system enhancements, and by policy makers to understand the context of the choices they are asked to make. The value-based planning process takes a long-term view of system needs to establish an efficient plan that is value driven and, when integrated with shorter-term needs, endeavors to produce the most efficient and reliable transmission system achievable. Similar to CCNs in Texas, cost recovery policy for Multi-Value Projects (MVP) allows 100 percent of the transmission cost to be passed onto load. A postage stamp method based on per-megawatt-hour charge is applied for load-serving entities, export transactions, and pass-through transactions to recover costs.

Criterion 1 specifically relates to transmission expansion to meet the RPS within Midwest ISO states. The high-level steps involved with the first MVP study were as follows:

1. *Short-Term Energy Delivery Analysis*: The main objective of this analysis was to ensure that with the transmission expansion portfolio, the incremental increase in deliverability of wind energy was adequate to meet the state mandates in the planning horizon 10 year out. The critical first step in this study was to model the geographically diverse wind regions (wind zones) at the agreed-upon appropriate amounts. The National Renewable Energy Laboratory (NREL) published spatially diverse hourly wind generation output (developed by AWS True Wind, LLC). Wind zones in Midwest ISO were then modeled using these same hourly wind profiles. The study relied heavily on hourly security-constrained economic dispatch simulations that measure congestion and curtail generation, including in this case wind to relieve congestion. The same wind curtailments were then measured using the model, which included the transmission expansion. A comparison between the without and with new transmission simulation results provided the incremental increase in wind energy delivery. In addition, these simulations also provided both pre- and post-contingent hourly thermal loading on the new transmission lines.
2. *Short-Term System Performance Analysis*: Various studies were included in this analysis—Steady State, Transient Stability, Voltage Stability, Short

**Figure 3.15: The Value-Based Planning Approach Used by Midwest ISO**

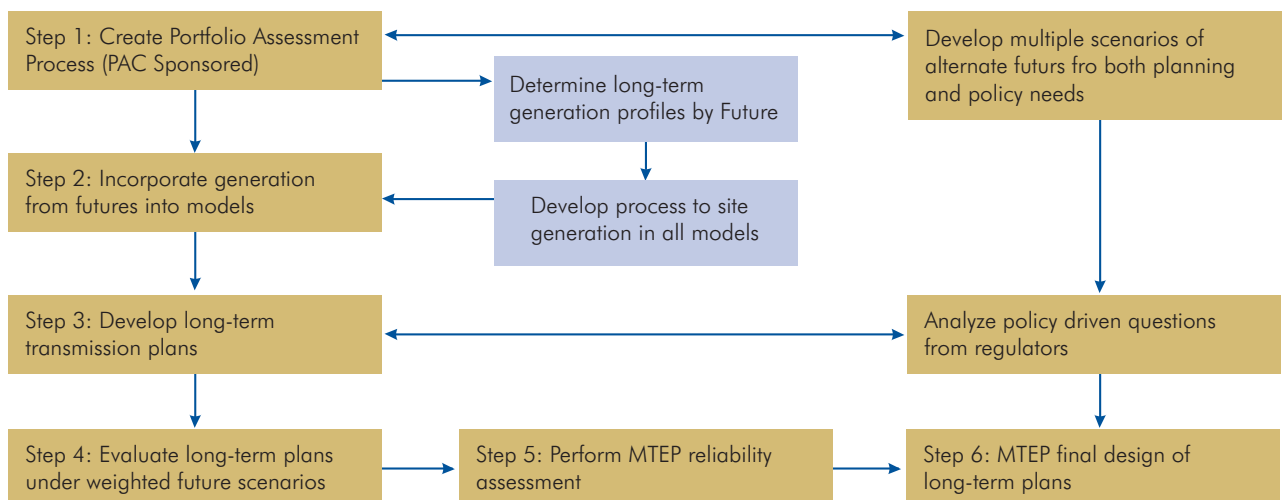

Source: Chatterjee 2010.

Circuit, and Production Cost. The objectives of these studies were to (a) ensure the transmission expansion meets all applicable reliability standards; and (b) if not, to include within the portfolio mitigations to identify constraints or, in other words, develop an alternate transmission plan. The production cost simulations were intended to help compare benefits in the case of multiple reliable transmission alternatives.

- 3. *Long-Term Economic Analysis:* While the short-term analysis focused on a 5- and 10-year-out planning horizon, the long-term analysis incorporated a 15-year-out horizon in addition to the short-term models. The objective of this analysis was to ensure that the selected transmission expansion was a “best-fit” robust plan when tested against a range of modeled future scenarios. These future scenarios developed with stakeholders essentially investigated different generation portfolio mixes and their impact on the developed transmission expansion. Some examples of these future scenarios are a 20 percent federal renewable mandate, carbon cap legislation, high energy growth rates.

By adopting the Value-Based Planning, Midwest ISO is able assess scenarios based on performance and short- and long-term economic analysis to ensure that the proposed transmission expansion plan meets all regulatory standards, as well as satisfies all current and future regulatory and consumer demands.

While the planning processes in Midwest ISO and other RTOs noted above have been long established processes, requirements to plan proactively to meet state mandates have increasingly become more urgent and have pushed Midwest ISO to make significant revisions to its planning process. The Midwest ISO is currently evaluating its first Candidate Multi-Value Projects Portfolio targeted for recommendation to the board for approval in its 2011 planning cycle. This group of projects (MVP starter projects) includes transmission lines in every region of the Midwest ISO footprint and represents about US\$4.6 billion in investments in the Midwest ISO region, to be developed over the next 10 years. In addition to advancing the integration of renewable energy projects necessary to meet defined public policy requirements, the Midwest ISO has determined that the MVP starter projects would alleviate major areas of congestion in the Midwest ISO, which would allow for the more efficient delivery of energy to load and also would result in substantial production cost benefits. Midwest

ISO projects that the MVP starter projects developed within the first 5 to 10 years following approval of the proposed MVP cost allocation methodology are expected to generate between US\$400 million and US\$1.3 billion in aggregate annual adjusted production cost savings. In addition to production cost savings, the Midwest ISO estimates development of the MVP starter projects to result in an annual reduction of approximately 2 million MWh in transmission system losses. About US\$104 million of additional savings are attributable to this reduction in losses. Moreover, reducing system losses also reduces capacity reserves required to maintain reliability, resulting in an estimated US\$110 million savings from deferred capacity investment. The reduction in system congestion resulting from construction of the MVP starter projects could also lower the planning reserve margin (PRM) requirement for the Midwest ISO. Even a relatively small reduction of 0.5 percent in the PRM would result in the deferral of about 500 MW of capacity investment, saving approximately US\$500 million. In addition to the projected savings in congestion costs and losses, development of MVP projects will provide regional reliability and other benefits.

As set forth in Midwest ISO Attachment FF (Midwest ISO 2010a) per the approved FERC order, in order for a transmission project to qualify as an MVP, it must meet at least one of the following three criteria:

- *Criterion 1:* The project must be developed through the transmission expansion planning process for the purpose of enabling the transmission system to deliver energy reliably and economically, and support documented energy policy mandates or laws that directly or indirectly govern the minimum or maximum amount of energy that can be generated by specific types of generation in a manner that is more reliable and/or more economic than it otherwise would be without the transmission upgrade.
- *Criterion 2:* The project must provide multiple types of economic value across multiple pricing zones with a total project benefit-to-cost ratio of 1.0 or higher, as defined in Section ILC.6 of Midwest ISO Attachment FF (Midwest ISO 2010a). In conducting the benefit-to-cost analysis, the reduction of production costs and the associated reduction of locational marginal prices resulting from a transmission congestion relief project are not additive and are considered a single type of economic value.
- *Criterion 3:* The project must address at least one transmission issue associated with a projected

violation of a North American Electric Reliability Corporation (NERC) or Regional Entity standard and at least one economic-based transmission issue that provides economic value across multiple pricing zones. In this case, the project must generate total financially quantifiable benefits in excess of the total project costs based on financial benefits and project costs, as defined in Section ILC.6 of Midwest ISO Attachment FF (Midwest ISO 2010a).

The flow chart in Figure 3.16 summarizes the planning process followed by Midwest ISO at a high level.

### 3.2. New Technical Planning Options

As described in the previous chapter, transmission planning plays an important role in ensuring that transmission costs for renewable energy are reduced and that interconnection requests by renewable energy providers are addressed more effectively. For instance, using the anticipatory approach to develop shared networks for renewable energy providers in a given resource zone can greatly reduce the costs, as shown in the case of Brazil and the Philippines. Similarly, as shown in the case of wind power development in La Ventosa region in Mexico, an organized planning process helps by responding more effectively to all interconnection requests in a given region rather than treating them individually. Furthermore, as displayed in the case of Texas and Midwest ISO, transmission planning can be further optimized by proactively

ensuring that transmission reaches the zones where the renewable energy potential is more effective.

Anticipatory or proactive planning for transmission requires new tools and an open participatory process to implement the transmission planning function. On the tools side, determining transmission expansion options for a large number of projects in a wide geographical area becomes a challenge. The number of possible combinations of high-, medium-, and low-voltage solutions to create shared or unshared networks that save on cost could be so high that heuristic methods—trial and error or experience-based—would be very limited or could not be used to find good solutions. In addition, proactive planning to bring transmission for the zone with the best resource potential requires tools that can link resource assessment with combined generation and transmission planning methods. Additionally, geospatial information becomes a crucial tool to determine resource potential zones and integrate such zones more effectively in transmission planning methods. When the costs involved in expansion options to achieve long-term renewable energy plans are considerable and subject to uncertainty, transmission planning needs are implemented using risk-based or robust assessment options. Gathering the information required for all the modeling approaches, ensuring that opportunities are not being left out, and making sure that other important parts of the planning function are not forgotten requires an open and participatory process for planning.

This section initially will provide a brief overview of traditional transmission planning methodologies, followed by explaining some of the new analytical tools and implementation processes. These tools and processes are emerging as highly valuable to determine low-cost expansion options and to effectively expand transmission services to renewable energy zones.

#### 3.3.1. Basics of Transmission Planning

Until about a decade ago, transmission planning was primarily driven by one or more of the following needs: (a) the need to interconnect single developers' large power plants to the grid, (b) the need for load growth, or (c) the need for reliability improvement. The time needed to take generation planning to commissioning was generally well over the time needed to take transmission planning to transmission construction. Now wind farms, for instance, can get commissioned within as little as six months. In addition,

**Figure 3.16: Midwest ISO Transmission Planning Process**

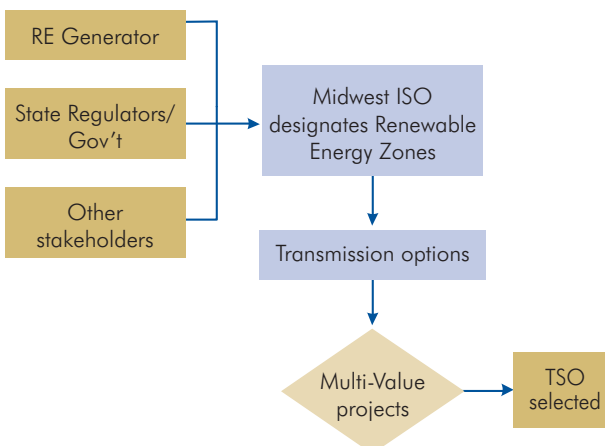

Source: Prepared by the authors.

these wind farms may be built by multiple developers located generally in rural areas where transmission networks are intended to bring power to remote loads, not to carry power to the main interconnected system or load areas. Transmission congestion or the lack of transmission became a big hurdle in the interconnection process. The traditional “reactive” transmission planning approach to integrate native generation just does not work within the renewable planning context. Waiting for generators to express their interest in interconnecting to network and attending to such requests individually can strain utility resources and finally delay the interconnection process. In addition, reacting to interconnection requests individually can lead to significant cost inefficiencies.

These issues have challenged the entire transmission industry to rethink planning studies and processes. Some of the most important improvements will be described in this paper. While some adjustments have been made by introducing new techniques and tools, some of the main principles behind transmission planning remain valid and important. These principles have been guiding transmission planning for a number of years and are described next.

### 3.3.2. Overall Principles and Methodology of Traditional Transmission Planning

Historically, the objective of transmission planning is to determine the required transmission equipment to satisfy the needs of transporting energy from supply to demand following certain requirements. These requirements are usually driven by specific guiding principles, such as cost minimization, reliability, and environmental considerations.

Transmission planning can have different time scopes. Short-term planning focuses on determining immediate needs, while midterm planning focuses on determining needs for the next two to five years. Usually short-term or midterm planning is carried out in connection with regulatory requirements for cost recovery of the transmission assets. Short-term planning could focus on immediate reliability and interconnection needs in specific areas of the system or the system as a whole. Long-term planning refers to identifying transmission needs for usually a 5- to 20-year timeframe. This type of planning is usually carried out in connection with generation expansion planning to identify a long-term development vision of the network as a whole.

Cost minimization has historically been the driver for planning transmission; it is always desirable for the necessary buildup proposal to be the minimum-cost option to avoid wastage of resources. Since supply must meet demand instantly, the interconnected network needs to be designed in such a way that the loss of an element in the networks does not necessarily lead to large disconnections of load or, worse, to systemwide blackouts. The reliability of the network will ensure that despite anticipated or unanticipated events, the transmission system will be able to provide the service required to deliver electricity to consumers. The construction of transmission infrastructure can also have important implications for the environment. Analyzing alternatives with less environmental and social impact is also an important principle of the transmission planning function. Avoiding impacts on natural parks and reserve zones, or minimizing impacts on vegetation and diversity can also affect the on the selection of alternatives.

There are trade-offs among the principles that transmission planning usually follows, especially when it comes to cost and reliability. A highly reliable network will be more costly (see Figure 3.17), since it will require more investment to achieve redundancy and extra equipment to ensure that a wide range of unexpected events can be handled by the network without disrupting electricity services. A low-reliability network will be less costly, but it could lead to high economic losses. To manage these trade-offs, reliability criteria are traditionally established by the planning or regulatory agencies. Transmissions planners internalize these criteria in the planning methodologies to ensure that these trade-offs are managed properly. There are different ways to determine such criteria, but the basic principle is to balance between costs and benefits. That is, criteria can be set as high as society can afford.

**Figure 3.17: Cost and Reliability Trade-Off**

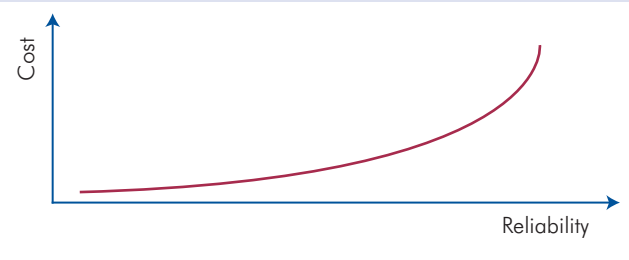

Source: The authors.

Reliability can be separated into two groups, steady-state and dynamic-state reliability. *Steady state* refers to the operation of the system at a given point in time during normal operating conditions—a snapshot of the system once the dynamic behavior of the network has settled. *Dynamic state* refers to the behavior of the system after system, generation, or load changes, usually from a few milliseconds to seconds and before the system may reach a steady state. Steady state is reached if voltages and frequency in the network reach their normal operating levels without any further variations in time and little or no load shed.

One of the most widely known steady-state reliability criteria is the so-called N-1, which means that the transmission systems should be able to deliver all electricity from generation to demand despite the loss of any single network element. For instance, if a city is supplied from a major transmission substation, it would be desirable that the substation be fed from two different transmission routes, so that the loss of one line does not leave the city without electricity. In some systems, such reliability criteria is extended to the N-2 contingency, which means the transmission system should be able to supply all the load despite the loss of two network elements. To verify that such criteria are being met by a proposed transmission buildup, steady-state or power flow models must be used.

Dynamic-state reliability criteria usually verify that, after loss of an element or fault in the systems, the system voltages and frequency fluctuations cede to a stable condition with minimal load loss. The dynamic behavior of the systems depends on the severity of the changes in the system, the time and place in the system where it occurs, and the way the load, transmission, generation, controls, and protections in the system interact. The transmission system plays a more critical role in certain dynamic behaviors of the system than others. Appendix C lists some steady-state and dynamic reliability criteria. As mentioned before, choosing a larger number of criteria or stringent criteria will always require understanding the implications. Utilities in developing countries have implemented alternatives to manage such trade-offs and determine the right level of reliability given the specific system conditions.<sup>5</sup>

While planning methodologies can be highly complex, the basic building blocks of any methodology

could be summarized as follows: (a) generation and demand projections; (b) reliability criteria considerations; (c) analysis of alternatives or minimum cost selection; and (d) reliability or trade-off analysis (see Figure 3.18). Practical implementation of the building blocks will depend on the key characteristics of the system that can impact the planning of such a composition of generation sources and interconnection with other regions or countries. Refer to Appendix B for an illustration of the building blocks of technical planning used by the planning agency in Colombia.

Given the uncertainties involved in longer-term planning studies, more emphasis is usually placed on the economic analysis of alternatives and on steady-state reliability criteria. For shorter-term planning studies, more detailed steady-state and dynamic reliability criteria are required, while the economic alternatives to expand transmission may be limited to fewer options and exhaustive identification of alternatives may not be required.

**Figure 3.18: Building Blocks of a Basic Transmission Planning Methodology**

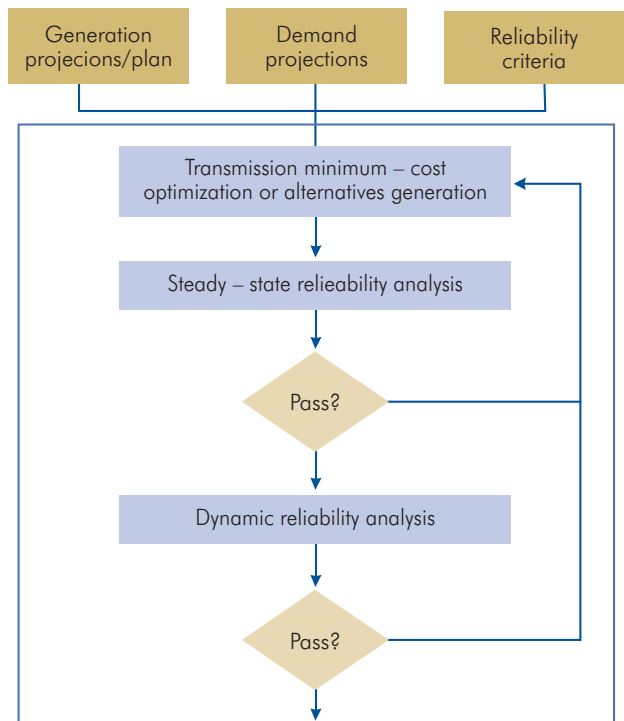

Source: The authors.

<sup>5</sup> See, for instance, the regret analysis implemented in Peruvian electricity in Cámac and others 2009.

### 3.3.3. Overview of Tools to Assist Traditional Transmission Planning

Unlike generation planning, the technical process of transmission planning will always require several tools. The different stages in a transmission planning methodology (alternatives, reliability analysis) require different modeling approaches. For instance, identifying expansion options for particular areas of a small network in a short-term planning process could be done by means of load-flow simulations with inputs from the planner experience. However, for a large meshed network, and especially for long-term planning processes, the number of alternatives could be exponential, and tools for automatic selection or generation of minimum-cost alternatives might be required. Analyzing the economic implications of transmission projects would, in addition, require production simulation models. Unlike load flow models, production simulation models do determine the operation cost of the system, given a specific combination of generation, demand, and transmission network. They are useful for determining the economic benefits of transmission additions.

Analyzing the reliability of the network requires different tools. Refer to Appendix B for a table describing the objective of various models and how they assist in the planning function, including the names of some commercially available models. All steady-state reliability criteria can be analyzed using load-flow models, which can determine the loading condition of all elements in the system and the steady-state conditions after elements are taken off the system. However, analyzing the dynamic behavior of the system during disturbance conditions requires different tools. These tools include angle stability models, voltage-stability models, and time and frequency domain simulation of small-signal frequency and voltage analysis.

The selection of tools depends on a number of factors, including cost, capability of the models, and the knowledge of the users. More importantly, the specific characteristics of each system will play an important role in selecting the model. For instance, planning for a small and radial system may not require sophisticated models to generate hundreds of alternatives, since most of the alternatives will be evident to the experienced planner. If the transmission planner is also responsible for generation planning, new generation and transmission planning tools are becoming increasingly available.

Technical planning, as described above, is just part of the overall planning process. The overall planning process (see Box 3.1) depends on the industry regulatory framework, as well as on the characteristics of the transmission system in question. Systems with considerable connections to other neighboring regulatory jurisdictions (states or countries) should require full interaction with the planning processes of the neighbors. In addition, especially for short-term and midterm planning, all generation stakeholders, environmental agencies, and consumers groups should ideally become part of a consultative process. An open and consultative process is important for making sure that all interested network users provide their inputs to the planning process. A more open process ensures that opportunities to reduce costs further are not missed and that other forms of transmission development, such as merchant transmission, if allowed by the regulatory framework, are also considered in the process. Transmission planning in most regulatory frameworks serves a specific purpose; it is rarely a pure, indicative process. The final stages of the planning process are usually related to regulatory or budgeting approvals by the respective regulatory or other agencies.

Independent of the body that is responsible for planning, the process should be consistent and well established. A

Box 3.1: The Overall Transmission Planning Process



well-established transmission process should be repeated annually. The preparations for the next year's planning process should traditionally commence before the current year's process has culminated.

### 3.3.4. New Useful Modeling Approaches for Transmission Planning with Renewable Energy

The existing modeling tools and approaches described above can be used effectively to plan transmission for systems with and without renewable energy. Combining short-term simulation models with long-term simulation models can suffice to provide an understanding of the impacts of the variability of renewable sources in line utilization and provide adjustment to the solution identified with long-term planning models, whose highest resolution tends to be monthly or seasonal. In addition, when planning to integrate a number of projects in a given geographic area or even for longer-term targets, it will be necessary to evaluate a tremendous amount of network options to interconnect high numbers of small and dispersed sites. In such conditions, models that can automatically generate transmission expansion options using geospatially referenced coordinates and greatly speed the planning function. Long-term planning is subject to a number of uncertainties that cannot be easily modeled. These include technology prices, regulation regarding carbon prices, and the timing of investment decision outside the control of the planner. Even though risk-based planning has been already embraced for a number of years in power planning, it has become increasingly useful when planning for long-term integration of renewable energy targets. This section briefly overviews these modeling approaches and provides examples of their applications, as well as pointers to the tools.

### 3.3.5. Risk or Trade-Off Scenario Planning

Risk and uncertainties are constantly present in the energy sector. When it comes to making long-term planning decisions, not incorporating uncertainties and understanding the associated risks of decisions can lead to incorrect decisions. While some uncertainties are better understood and can be modeled, other uncertainties are less understood and harder to model. For instance, the seasonal variability of hydropower production has long been considered in hydropower planning, dual stochastic dynamic approaches have been developed in the power industry to incorporate such risks in long-term and short-term planning

and operations tools, which have been available commercially for a number of years. However, uncertainties, such as the cost trend of new technologies, the introduction of a new regulation, and other decisions outside the reach of the planner, cannot be easily modeled. Risk or trade-off scenario planning is a better tool for incorporating such risks in long-term planning.

In addition to the above uncertainties, policy makers require better tools for understanding the trade-off of strategic decisions or inputs to a planning process. Examples of such strategies could include considering that renewable energy targets can also be met with imports, incorporating new technologies to a system (such as DC tie-lines), or requiring that transmission across borders be limited or not to a given size. Risk bases or scenario planning is an extremely useful tool for understanding the long-term implication of such choices in terms of their cost, benefits, and risks. That is, scenario planning is a framework for more robust decision making. Scenario planning does not substitute the tools that are necessary for transmission planning. Scenario planning is a framework for robust decision making based on the results of such tools. That is, scenario planning does not necessarily require specific additional planning tools.

Table 3.6 briefly describes a number of applications where scenario planning has been used for different transmission planning problems, including the combined planning of transmission and renewable energy zones.

### 3.3.6. Long-Term GIS-Enabled Generation and Transmission Planning with Hourly or Sub-Hourly Resolution

Another helpful characteristic of new planning models is their ability to process geographical information data that contain the location of the renewable energy sources that will be considered in the planning process, as well as the exact location of existing transmission infrastructure. Given the territorial dispersion and the huge number of renewable energy sites that need be explored, the use of geospatial information systems and of planning models that can process such information has become critical. If planning models can handle time-step resolutions in their simulations that can represent the most important variations of new renewable sources, such as wind and solar, transmission-size decisions will be more efficient.



### Table 3.6: Risk-Based and Scenario Planning Approaches in Transmission and Renewable Energy Planning

#### Planning large interconnections across countries: The case of the SIEPAC interconnection in Central America.

**Planning problem.** Determining the right size of the transmission line that had to be built among the six countries in Central American (Costa Rica, El Salvador, Guatemala, Honduras, and Panama) in order to increase the benefits of integrated operation and trade in a market environment. \*

**Uncertainties.** Since power generation development is outside the control of the transmission planner and each country has its own mechanism to ensure generation adequacy, assumptions on generation development and the level of generation trade that could happen in the future are highly uncertain. Other uncertainties, such as the availability of natural gas in the future and the development of large hydropower plants, are also considered.

**Strategic options.** Decisions on introducing different transmission line strategic options, such as 500 kV, 400 kV, and 230 kV lines with different capacities.

**Risks.** The uncertainties and major risks that are associated with selecting a strategic option can lead to wasting resources, such as a transmission line whose expected benefits are not realized. This includes avoiding construction of a transmission line whose capacity is too large if the assumption (for example, availability of hydropower) does not materialize.

**Trade-off analysis and decision approach.** The trade-off analysis is based on comparing the cost and benefits (reduction in operational and investment costs) of all strategic options and determining how these benefits change with different assumptions concerning the primary uncertainties. The most robust option is whose benefits are more conservative (or less regrettable) among all possible uncertainties. The costs and benefits are computed with production simulation models.

**Other benefits of the approach.** Robust analysis is a framework that facilitates strategic decision making by policy makers who are not necessarily familiar with all complexities of power system planning and operation. This gives a clear description of the attributes of each strategic option and how these attributes (costs and benefits) could change, given major uncertainties. This framework avoids biases by planners toward higher buildup options and effectively incorporates uncertainties that cannot be easily modeled.

#### Proactive scenario-based planning for joint wind zone and transmission development—the case of Midwest ISO

**Planning problem.** Determining the most cost-effective way to expand transmission and achieve varied-state renewable energy across the 13 states in which Midwest ISO is the system operator.

**Trade-offs.** The main trade-off to analyze is whether renewable energy mandates in each state should be met with renewable energy produced inside the state, possibly at lower transmission costs, or if it should be met by outside the state, possibly at higher transmission costs.

**Alternatives.** Fourteen different generation production options were developed to meet state renewable targets. There are options in each extreme—targets met only with in-state generation and targets met with best regional sources—and options in between.

**Scenarios.** For each generation alternative, transmission plans were developed using inputs from all transmission-owning companies and guided by production simulation models. For each scenario, the combined generation and transmission cost is computed.

**Analysis and decision.** The total cost of each alternative is compared, and the trade-off becomes evident, as presented in the figure. Meeting targets with local generation would be costly, but so will meeting targets with regional generation. Given the specific conditions of the Midwest ISO region (existing transmission, location of demand, resource site locations), it is most cost-effective (transmission and generation cost) to meet targets with a combined in- and out-of-state generation mix, even if transmission needs to be built up. See Figure 3.13.

**Other benefits of the approach.** The approach does not necessarily require specialized tools to generate combined generation and transmission plans. The two-stage process is a proxy to combined generation and transmission planning, subject to renewable energy targets.

\*More details of the approach can be found in de la Torre and others 1999.

Intrahourly or hourly wind power variations can only be captured if the models have such resolution. Introducing relaxed reliability criteria would be very helpful for analyzing when “spilling” wind or solar energy would be worth saving the extra transmission costs.

These modeling approaches lead to problems that are computationally hard to solve (for example, nonlinear combinatorial problems). For this reason, most of these models have limitations on accurate modeling of the transmission network. For instance, most models in this category will consider DC or other linear-network approximations of the load-flow equations, which cannot determine voltage and reactive power behavior of the network. This will require the use of other more complete models (such as load flows) to verify that other technical viability factors are complied with (for example, overloads resulting from voltage variations). In most cases, these models are extremely useful for providing a long-term vision of investment needs and the best overall technological and transmission strategies (for example, identifying voltage levels and the type of technology—alternating current (AC) or DC—and defining strategic corridors).

Box 3.2 presents some of these modeling approaches and describes the renewable energy integration planning studies that have used them. Most of the investment needs presented in the first chapter of this report were obtained from studies using this or a similar type of long-term modeling approach.

These approaches can consider an hourly simulation resolution and geographical information data within the context of long-term planning problems. These models have been developed for the specific purpose of addressing a transmission planning issue related to renewable energy and have been used to inform policy decisions or to identify actual transmission needs for a number of projects in a given region. While a combination of existing models (see Box 3.2) can also be used to generate expansion options—for example, using operator experience aided by production cost simulation and load flows models—the models presented in this section have some useful characteristics that are worth highlighting, because their characteristics speed up the planning process and make it more efficient.

Since some of the models described above have the capacity to automatically generate transmission expansion alternatives to bring transmission to different sites, they tend to be highly useful when it comes to designing shared networks for renewable energy projects in a given zone. Appendix C presents the mathematical model of shared network planning as implemented by the PSR model in Box 3.2.

### 3.3.7. Methods for Developing Renewable Energy Zones for Planning Studies

Long-term proactive planning to identify the best combined renewable generation and transmission

#### Box 3.2: Some GIS-Enabled Transmission Expansion Models with Emphasis on Renewable Generation

##### United States: NREL Wind Development System (WinDS)

**Model description.** A multiregion, multiperiod, GIS, and linear programming model of capacity expansion for the electricity sector.\* The model, developed by NREL, is focused on the United States. The model’s main objective is to assess the cost of transmission to integrate a large amount of renewable energy into the system and to understand some of the intermittency issues of wind power. The model is a linear programming formulation whose objective is to minimize the cost of generation and transmission, including capital and operational costs, as well as the cost of ancillary services. The model considers 25 2-year periods. Each year is divided into 16 subperiods, and each day is subdivided into four subperiods. The latter subdivision allows for understanding some of the short-term variability aspects of wind.

**Primary model application.** Used to produce a generation and transmission expansion for the United States that will achieve a 20% wind energy penetration by 2030. Based on the combined cost of generation and transmission (plus operational cost), the model determined that 293 GW of new wind generation capacities need be installed. The model determined the optimal renewable energy sites to develop, along with the required transmission lines. The figure below describes the new (optimal) transmission corridors required to develop this much wind.

(continued on next page)

Box 3.2: Some GIS-Enabled Transmission Expansion Models with Emphasis on Renewable Generation  
(continued)

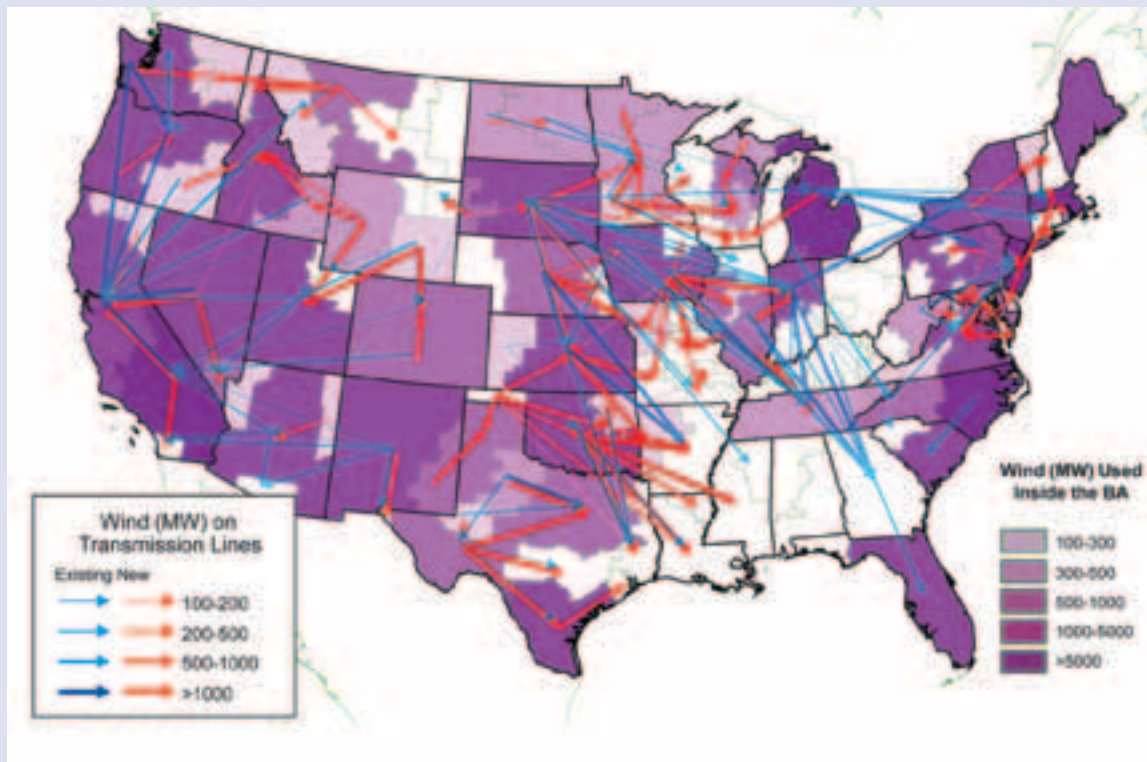

Source: U.S. DOE 2008.

Investments of approximately US\$60 billion in transmission to achieve the 20% wind penetration by 2030 were identified by the WinDS model. This would be approximately US\$3 billion per year over the next 22 years. As can be seen, the transmission capacity that has increased in high-quality wind resource areas in the Midwest is the result of the generation and transmission combined-cost minimization method.

### PSR—Netplan Suite

**Model description.** A transmission planning model whose objective is to find the minimum-cost transmission network to connect a set of generators in a geographical area. The model minimizes both capital and operational costs (losses) of transmission and uses GIS data as inputs to generator locations. The model is a mixed integer quadratic formulation and, as such, it can evaluate a number of industry standard transmission voltage and conductor size options to define the best interconnection to a group of generators. The model generates an optimal arrangement of collectors and intermediate substations to connect generators. A detailed description of the model can be found in Box C.1.

**Primary model application.** The model has been used to determine the subtransmission network to interconnect baggage cogeneration in certain regions in Brazil, specifically the zone described in Chapter 3 of this document. The model has also been used to determine the best connection strategies for potential renewable generation projects in the island of Luzon in the Philippines, which was also presented in Chapter 3.

\*For a detailed description of the model and documentation, consult the WinDS website, <http://www.nrel.gov/analysis/winds/>.

options requires new data previously not collected by planning studies with conventional generation. Such data refer to reliable projections of the renewable energy source potential and their locations. Creating reliable projections of renewable potential is a task that requires handling huge amounts of data that need to be preprocessed to create manageable and meaningful data for long-term planning purposes. The characterization of the resource (for example, wind speed and solar irradiance variation), together with their locations, needs to be transported into power production patterns by considering specific technologies. For a large territorial area, wind or solar projections will identify thousands, or millions, of sites that are good candidates for generation installation because the wind and solar irradiance there can be considered of good quality. However, from the planning perspective, it would be unrealistic and computationally intractable to manage millions of sites as individual candidate power stations. For this reason, most proactive long-term renewable integration studies need to perform large amounts of preprocessing to identify only a subset of the areas with the highest potential in order to be considered candidates in the power planning scenarios. This basically reduces the number of variables and makes the setup of the model more credible and manageable.

Box 3.3 summarizes the process followed by Midwest ISO to identify the wind power resource and process all the information until it becomes usable for traditional planning models. The main objective of zone development is to reduce the number of sites to be considered in the transmission planning study, which would make the problem tractable. In doing so, the process already identifies zones that are of higher resource quality and at the same time avoids zones that are evidently nonexploitable for other reasons or for their evident high transmission costs.

### **3.3.8. Open and Participative Stakeholder Process to Improve Planning Outcomes and Broad Stakeholder Process**

The value of stakeholder input in the transmission planning phase simply cannot be overstated. Planning around large-scale renewable energy is driven by a number of factors besides reliability cost, reduction in emissions, and renewable energy targets. A diverse stakeholder group is critical in providing input on

reasonable assumptions in planning study, as well as quantification of a range of benefits commensurate with transmission investment. An organized stakeholder process is a prerequisite for obtaining all the relevant information on potential renewable generation development that is required to perform proactive cost-effective planning.

### **3.4. Combined Impact of Transmission Planning and Pricing on Renewable Energy Development**

The last two chapters highlighted the impacts of connection cost allocation, network pricing, and planning practices on delivering transmission for renewable energy. On the pricing side, it is evident that low, or not at all, transmission charges that are applied to renewable generation can lead to more effective (rapid) development of renewable resources in settings where renewable generation is provided by multiple, public or private, participants. On the planning side, it is also clear that planning proactively plays a key role in reducing cost and improving the effectiveness of transmission companies to provide the requisite transmission.

A survey performed in the context of this work for 14 transmission jurisdictions in North America and Europe concluded that jurisdictions where cost allocation is low and planning practices are more proactive have larger shares of renewable in their systems. While this result may be mainly influenced by the policy mechanisms used to support renewable (such as FIT or RPS), as found also by additional research at the Bank (World Bank 2010a), it is clear that transmission cost allocation and planning practices play a role in reducing the transmission barrier, which leads to greater development of renewable sources (see Figure 3.19).

The review found that this result does not depend on the market structure of the jurisdiction under review, such as the level of unbundling or the size of the market. A detailed description of this survey is presented in the Madrigal and Energy and Environmental Economics (2010).

Part II of the report will focus on proving some general principles to help design transmission pricing and planning policies that should seek both efficiency and effectiveness.

### Box 3.3: Site Selection Methodology Midwest ISO Transmission Planning Study

- **Developing a Wind Resource Dataset:**

- Using the data compiled from state and regional sources, a detailed map of 11 years of wind speeds at 80 meters was developed. The data were used to estimate the net capacity factor for a composite IEC Class 2 wind turbine. In addition to the capacity factor, other layers, such as land area, topography, lakes, rivers, cities, metropolitan areas, state and federal lands, airports, and slope, were incorporated.
- Using the capacity factor map and an assumption for how many wind turbines could be placed in a specified area, a total potential wind capacity and energy in the eastern United States was estimated. Any areas deemed undesirable or impossible for locating wind turbines were excluded from consideration.
- Several methodologies, such as geographic diversity and maximum wind park size, were used to further prioritize the wind farms. From the 7,856 sites in the site selection list, NREL identified 1,513 sites totaling 651,091 MW, for AWS Truewind to apply the three years of 10-minute mesoscale (a three-dimensional numerical weather model) wind data. These 1,513 sites are referred to as the “selected sites.”
- The mesoscale model was validated for various potential configurations based on temperature, pressure, wind speed, wind direction, wind density, turbulent kinetic energy at five heights, specific humidity, incoming long-wave and short-wave radiation, and precipitation.
- From this reviewing process, Midwest ISO identified an additional need outside the scope of the original request of AWS Truewind. Midwest ISO performed a gap analysis of the wind sites selected and identified additional sites where it wanted mesoscale wind data developed. NREL was able to work with AWS Truewind to incorporate these additional sites, and the data are included on the NREL website.

- **Generating Wind Plant Output:**

- AWS Truewind ran a simulation model to convert the mesoscale wind data to the selected sites. Blended power curves were then created and used to calculate the power output of each site based on composites of various turbines.
- The 10-minute data may be converted to hourly data by taking the average output for each hour. This methodology was accomplished by Midwest ISO and NREL in their studies. The bulk of the sites fall between 200 MW and 600 MW in size. A small number of megasites located in the Great Plains with rated capacities exceeding 1,000 MW were also chosen.

- **Developing a Renewable Energy Zone Scenario:**

- Several capacity factor metrics were calculated to analyze the wind data to determine the appropriate measures for ranking the renewable energy zones. This was to answer the questions about the variability and timing of wind production and also to determine whether there were areas where wind energy performed better.
- A range of statistics was created based on time and applied to each site, which included correlation of wind to load, ramp, and correlation of wind sites to distance from each other.
- Based on the above steps and procedures, RE zones were considered options for generation expansion in planning models.

Sources: World Bank with information from Midwest ISO 2008.

**Figure 3.19: Impact of Transmission Planning and Cost Allocation on Renewable Energy Penetration**

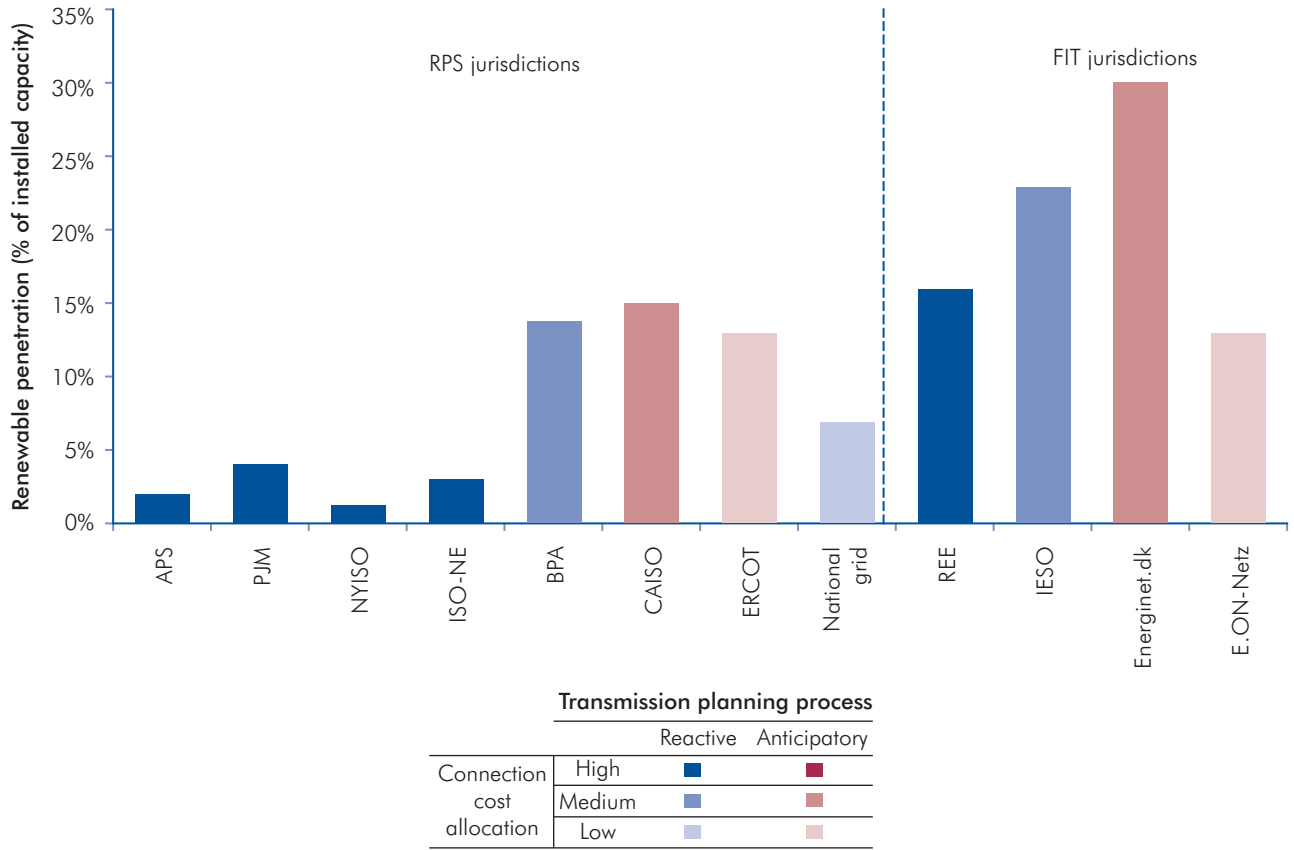

**PART II**  
**RENEWABLE TRANSMISSION DEVELOPMENT:**  
**ECONOMIC PRINCIPLES**





## 4. TRANSMISSION AND RENEWABLE ENERGY, THE BASIC TRADE-OFF

Part I of the report discussed the increasing need to develop transmission for renewable energy scale-up. Emerging cost recovery and pricing practices, as well as new planning approaches, have been reviewed. These experiences provide important insights on the different efforts to improve the effectiveness and cost efficiency of delivering transmission services for renewable energy. Taking from the emerging experience described in Part I, Part II of the report focuses on developing general economic principles that could guide transmission expansion planning, pricing, and cost allocations for renewable energy in different contexts.

### 4.1. Different Types of Entities that Provide Transmission Service

Some transmission companies build and maintain transmission, but have no role in deciding what transmission will be built or what prices will be charged for transmission. Such companies are not of interest in the present context, because this report is concerned only with transmission investment decisions and the design of transmission tariffs. There are, however, many types of private and government entities that do make transmission investment decisions. To understand their behavior, it is useful to group them according to their incentives. Four different types are briefly described in this section, and some of the incentives or functions regarding transmission planning are described.

The first type (Type 1) comprises unregulated generation owners that supply some of the transmission facilities that are specific to their needs. These include connection costs, and sometimes “shallow” transmission investments as well. Second, in Brazil, there is an example of a number of renewable investors working cooperatively to build shared lines. These two categories of investors comprise our first type of transmission provider (World Bank 2010b). Cost-sharing agreements require cooperation among competitors, so cooperative transmission investment should not be expected to be generally successful even for shallow transmission needs. However, the Brazilian scheme takes advantage of a natural focal point for cooperation that occurs when transmission is radial and serves only generation. In this case, there is no ambiguity about how much power flowing on each line is attributable to each

generator, so costs can be assigned unambiguously in proportion to power flows.

The second type (Type 2) is Unregulated Merchant Transmission Investors. These are unregulated transmission private investors that develop lines and charges for their use at negotiated (not-regulated) prices. So far this activity is almost completely limited to DC lines because the flow on these lines can be controlled easily, while the flow on AC lines is expensive to control.

Type 3 comprises Independent System Operators and Transmission Service Companies and is similar to the previous case in that its business is only transmission and not generation. Type 3 includes these regulated TSCs. Usually they are paired with a deregulated generation market. A prime example is the National Grid Company in England. Independent system operators are regulated private companies that run electricity markets. They also often play the role of transmission provider. They are similar to TSCs, but have somewhat different incentives because of their greater concern with market power in the wholesale power markets they regulate. They also do not own the wires, as regulated transmission providers do.

Lastly, Type 4, or Vertically Integrated Utilities and Government-Owned Power Companies both typically own most of the generation they need and the entire transmission system within their territory. This gives them the best incentive for co-optimizing generation and transmission. However, they may have poor incentives for providing transmission for independent power producers. These independent producers may be viewed as competitors with the utility’s own generating facilities.

Each of these four types of transmission investors has different incentives and different limitations. Within the regulated types, each implementation has its own individual set of rules and incentives. Because of this variety, no attempt will be made to specify particular incentives that could be applied to induce a transmission provider to build the right transmission upgrades. Instead, Part II will investigate only how to determine which upgrades should be built. Upgrading transmission wisely requires transmission planning. This should be possible for Types 3 and 4. However, any of the Type 3 or 4 transmission providers will need to be instructed as to their appropriate goal, and some form of incentive will need to be provided.

## 4.2. Primary Objectives: The Reduction of Fossil Fuel Externalities

Two of the main reasons that renewable energy is pursued are its global climate benefits and its fuel diversity benefits. There are other benefits, such as job creation, which are not necessarily particular to renewable energy. In the case of global warming, the benefit of emitting 1 ton less carbon dioxide is constant, regardless of how much renewable energy is generated. In this case, renewable energy should, in theory, receive the same subsidy per ton of emissions avoided regardless of how much renewable energy is produced in total.

Fuel diversity is a different objective. As the percentage of fossil fuel used by a given region is reduced, the value of increased fuel diversity is also reduced. Hence, it makes sense for a subsidy rate to decrease as the overall production of renewable energy increases. However, at low levels of renewable penetration, this effect is generally too small to consider.

Although reducing CO<sub>2</sub> emissions (which will also increase fuel diversity) is the primary motivation for a renewables policy, policies should not be judged to be more successful simply because they “accomplish more.” Any level of emissions reduction can be achieved by spending enough. A more comprehensive policy objective requires balance and trade-offs. A useful objective might be to obtain a certain level of renewables use, say, 20 percent at the least possible cost.

Another reasonable objective would be to produce as much renewable energy as possible for a subsidy of US\$30 per megawatt-hour or less. This objective is called a price target, and the previous objective is a quantity target. In either case, however, it is important to maximize renewable output for a given cost and to minimize cost for a given output. These are two ways of saying the policy should be economically efficient. This may seem obvious, but, in fact, it rules out many policies that simply fail to take into account standard methods of reducing costs. This idea is captured in Chapter 5, which discusses how the transmission provider can maximize the net benefit when making the basic trade-off between transmission costs and generation costs.

Having said this, it must be admitted that other political and institutional strengths are required to avoid the adoption of non-least-cost policies. However, it is important to keep this central economic efficiency principle in mind when designing a renewable transmission policy. When such principles are violated by design, it is important to be aware of this fact and the resulting inefficiencies.

While the impact of transmission costs in end user energy prices may be low if compared to the cost of support mechanisms to support renewable energy, these transmission costs could change the least-cost order of alternatives to achieve certain policy objectives, such as emissions reductions. An example that illustrates such a situation is described in Box 4.1.

### Box 4.1: Transmission Cost and Choice of Greenhouse Gas Mitigation Options

The cost of power transmission can alter the economic viability of generation technology choice to abate greenhouse gas (GHG) emissions as illustrated by the simplified marginal abatement cost analysis example below. The simplified marginal GHG abatement cost analysis uses a bottom-up approach to compare five-generation technology-based GHG emissions mitigation options and their costs adjusted for transmission.

The analysis compared subcritical coal without carbon capture and storage (CCS), combined-cycle gas turbine (CCGT), hydropower, wind, and concentrated solar power (CSP) plants with 400 MW installed capacity each.\* The generation technology’s baseline cost characteristics, fuel costs, and technical specifications were derived from existing technical and economic studies (ESMAP 2007; CSP Today 2009). A real discount rate of 12 percent, an auxiliary consumption of 11 percent, and a lifespan of 30 years were assumed for all generation technologies. Capacity factor of 80 percent was assumed for subcritical coal and natural gas, 50 percent for hydro and 30 percent for CSP and wind power. The transmission infrastructure cost characteristics for all the generation technologies were derived from IEA estimates for the United States (IEA 2011). Additionally, the 400 MW of wind generation was assumed to consist of four 100 MW wind farms with a cumulative 330 km of 230 kV transmission lines. Similarly, the 400 MW of CSP generation was assumed to consist of four individual 100 MW parabolic trough sites with a cumulative 400 km of 230 kV transmission lines. The analysis estimated the levelized cost of transmission (LCoT) to be US\$18.5/MWh for wind, US\$3.15/MWh for CCGT, US\$5.87/MWh for hydro and US\$13.43/MWh for CSP.

(continued on next page)

### Box 4.1: Transmission Cost and Choice of Greenhouse Gas Mitigation Options (continued)

A 400 MW subcritical coal plant without CCS was assumed to be the reference case scenario in estimating the GHG emissions reductions from the generation technologies. The carbon dioxide (CO<sub>2</sub>) and nitrogen oxide emission factors, as well as the heating value for coal and natural gas, were obtained from NETL and the U.S. DOE (U.S. DOE/NETL 2007). Methane emissions were assumed to be negligible from the CCGT plant. The emissions from the subcritical coal and the CCGT plants with 80 percent capacity factor each were estimated to be 828 Kg CO<sub>2</sub>eq/MWh and 318 Kg CO<sub>2</sub>eq/MWh per year, respectively.

As illustrated by the charts below, adjusting the marginal abatement costs (US\$/ton CO<sub>2</sub>) of the generation technologies for transmission swaps the economic attractiveness of the wind and CCGT technologies. Wind generation was a more economic alternative for GHG emission mitigation than the CCGT plant prior to the transmission adjustment. However, inclusion of transmission capital and operating costs resulted in the CCGT generation's becoming a marginally cheaper alternative to wind. Prices of US\$18.1/MWh associated with 325 km of transmission line for wind and US\$3.5/MWh associated with 120 km of transmission line for CCGT are the threshold at which wind technology becomes a less economic GHG abatement choice. While the costs of transmission are highly circumstantial, this example shows that transmission can modify the abatement cost associated with generation technology.

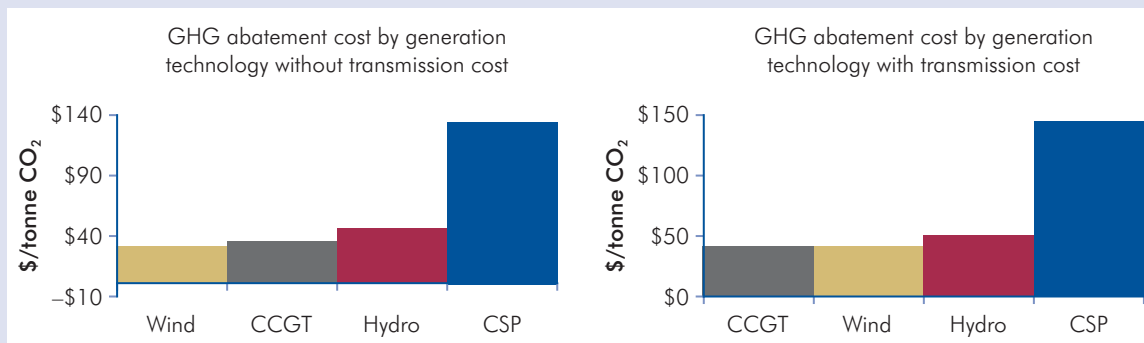

Source: U.S. DOE/NETL 2007. Subcritical coal, CCGT, hydropower and wind technology's baseline cost characteristics, fuel costs and technical specifications were derived from ESMAP 2007. The cost and technical characteristics of the CSP parabolic trough technology with storage were derived from CSP Today 2009.

\*Subcritical coal, CCGT, hydropower and wind technology's baseline cost characteristics, fuel costs and technical specifications were derived from *Technical and Economic Assessment of Off-Grid, Mini-grid and Grid Electrification Technologies* (ESMAP 2007). The cost and technical characteristics of the CSP parabolic trough technology with storage were derived from *CSP Today 2009*.

Note: The natural gas cost of 4.12 U.S. cents/kWh used in the analysis was based on the price of natural gas at US\$7/ MMcf (ESMAP 2007).

CCGT results in 62 percent GHG emission reductions whereas wind, hydro, and CSP result in 100 percent GHG emission reductions.

### 4.3. Interactions Between Renewable-Policy and Transmission Efficiency

This section describes some economic principles for dealing with negative externalities, as well as the concept of a Pigouvian tax, which is the basis of many modern approaches. These concepts will be used to understand how different support mechanisms for renewable energy affect the design and application of sound transmission expansion policy.

#### 4.3.1. A Pigouvian Tax as a Benchmark "Subsidy" Policy

A Pigouvian tax is the standard economic policy solution to the problem of a negative economic externality, such as carbon emissions. An externality is an effect that is external to the market and consequently is not included in the market price of the good or service whose production causes the externality. The classic negative externality is

environmental pollution, which was the concern of the English economist Arthur Pigou who formulated a tax for addressing such a problem.

A carbon tax is a Pigouvian tax, and cap-and-trade is a modern variation of such a tax. It is simply a Pigouvian tax whose rate is set by the market to ensure that a quantity target is achieved. Some form of a Pigouvian tax is advocated by almost all economists in preference to direct subsidies, which are considered more distortive in nature. This view was well testified to by the “Economists’ Statement on Climate Change,” which was signed in 1997 by more than 2,600 economists, including 9 recipients of the Nobel Memorial Prize in Economic Sciences. It concluded that “[t]he most efficient approach to slowing climate change is through...market mechanisms, such as carbon taxes or the auction of emissions permits.”

Some renewable policies make transmission planning more efficient and consequently make renewable generation cheaper and hence more likely to succeed, but if transmission efficiency comes at the cost of less-efficient subsidies for renewable generators, the policy that improves transmission planning cannot be recommended without careful study of the trade-off. However, if a policy modification will improve the efficiency of the renewables subsidy and also improve the efficiency of transmission investment, no complicated trade-offs need to be examined.

We now take a look at why a tax, or equivalently, a carbon price established by a permit market, is favored by economics. The purpose of this section is not to suggest the use of such a policy, but to understand it so that it can be used as a benchmark against which to compare the various policies that are in use. If these policies are found to make renewable transmission policy more difficult, but for a reason more aligned with an efficient economic benchmark, the transmission policy should be considered adequate. However, if the support policies exacerbate transmission planning difficulties and thus reduce economic efficiency, there is an indication to consider alternatives.

As mentioned above, a Pigouvian tax is the standard economic remedy for this type of problem. If a unit of product does \$X of damage, that product should be taxed at the rate of \$X per unit. The term *tax* should be interpreted broadly, as any charge that makes using the product cost \$X more per unit. So if a permit is needed

to burn a unit of fossil fuel (as under a cap-and-trade system), and the permit costs \$X, that is equivalent to a tax of \$X per unit. So this is also a Pigouvian tax. Subsidizing specific alternatives to the product that reduces the externality can be shown to be inefficient; the same can be said about mandating certain amounts of specific alternatives.

Subsidies are less efficient than a tax for several reasons. First, subsidies are likely to create an uneven playing field for all alternative products because there are simply too many such products. The cost and other characteristics are not well known to regulators. Second, alternative products substitute for the offending product to different degrees. For example, wind generation may take place more at night so it may replace more coal than solar power, which takes place in the daytime when gas is on the margin. A solar plant in one location might replace more fossil fuel generation than it would in another location. A Pigouvian tax handles these variations better by focusing on the undesired product (such as fossil fuel generation) instead of the myriad of alternatives to reduce the output of the undesired product, all of which have a different level of effectiveness. Subsidies would need to be extremely complex to take account of these effects.

Furthermore, taxing carbon will directly encourage other, more cost-effective, alternatives, such as conservation. However, even though a carbon tax (or a cap with traded permits) is the most economically efficient proposal, it may not be politically feasible. In such cases, it may be better to subsidize alternatives in an efficient way than to do nothing at all.

Since current renewables policies are mainly subsidy policies, we will focus on those instead of the more efficient carbon tax. However, understanding a carbon tax still serves as a useful benchmark. The closer a policy comes to mimicking a fossil tax, the more efficient it is likely to be. In other words, the more similar in effect it is to a fossil tax, the more it will accomplish for any given cost. The Pigouvian tax is the least-cost renewables policy.

#### 4.3.2. The Effects of Different Renewable Subsidies on Transmission Planning

A number of systems are in effect throughout the world for subsidizing renewable power. Perhaps the most popular of these is the feed-in tariff (FIT), which

generally sets a different energy price for each type of renewable energy project. A related approach is the production subsidy, which adds a constant subsidy on top of a fluctuating market price for energy, so the combined payment fluctuates. A third approach is the RPS, which determines a fluctuating, market-driven subsidy (similar to cap-and-trade), and which is then added to a fluctuating market price. This is a riskier form of subsidy from the investor’s perspective, but it is designed to meet a quantity target and, if fully enforced, it will meet that target.

These different approaches and the variations on them have different implications for what renewable generation will be built and how hard that will be to predict, and hence how hard it will be to plan transmission for what will be built. Box 4.2. presents some of the main implications of the different subsidy mechanisms on transmission planning. The following discussion examines in detail this question and also compares the subsidy mechanisms with the efficient benchmark.

### 4.3.3. Production Subsidies

Production subsidies have been used in many countries, including in some specific wind projects in Mexico and also in the United States. For example, in the United States, the largest wind subsidy has been the federal production tax credit, which is currently set at about US\$20/MWh. For the purpose of simplicity, we will assume that the credit is simply a direct payment for energy produced.

#### Box 4.2: Subsidies and Transmission Planning

A transmission planner will find it simplest to plan for a renewable policy that specifies the quantity of renewable energy that will be subsidized and built.

Policies that required the planner to predict quantities from price are more difficult for the planner, and the more quantities (for different technologies) that must be predicted, the more difficult the planning process.

If, however, the policy maker targets price for a sound reason, such as that the externality cost of emissions is known, or to mesh with a global emissions policy, the resulting planning burden is justified. However, if the renewable subsidy approach is inefficient and causes planning difficulties, it should be replaced.

If the wind generator is only in competition with coal-fired generation (either in a wholesale market or in a regulated setting), this is equivalent to about a US\$20/ton tax on CO<sub>2</sub>, assuming coal-fired power plants emits 1 ton of CO<sub>2</sub> per MWh produced. However, when wind is competing with gas, which is much less affected by a carbon tax, a US\$20/MWh production subsidy for wind is equivalent to a tax of between US\$30 and US\$40/ton of CO<sub>2</sub>. If wind is competing mainly against a combination of nuclear and solar, with much lower emissions, the production credit would be equivalent to a much higher carbon tax. This indicates inefficiency in the production tax credit, since it would be more efficient to reward any renewable generation type in direct proportion to its reduction of CO<sub>2</sub> emissions—as does a carbon tax.

A production subsidy causes no special problems for transmission development. However, if the production subsidies are unpredictable, they will create more uncertainty in the transmission planning process. Since transmission must be planned years in advance and will last for decades, planning for unpredictable generation investments is quite risky, and can lead to significant errors even if such risks are properly considered. If too little transmission is planned and built, this will discourage investment in wind, as well as cause the investments to be poorly located. If too much transmission is planned and built, the cost of the transmission could inefficiently rise. Of course, besides the regulatory risk of changes in the subsidy, there is also the market risk of changes in the price of electricity caused by changes in fuel costs and capital costs.

Finally, it should be noted that a production subsidy could easily be extended to other renewable technologies. If the credit were given to all fuels in proportion to how much less CO<sub>2</sub> they emitted than coal, it would come close to the efficiency of a carbon tax. This would make it more efficient and would significantly reduce the cost of achieving the twin objectives of less CO<sub>2</sub> emitted and greater fuel diversity.

### 4.3.4. Uniform Feed-in Tariffs

Some of the earliest feed-in tariffs (FITs) were simpler than the present-day FITs, because they treated most sources of nonfossil power equally, giving them the same price for the electricity produced. We will call this a *Uniform* FIT. These FITs can be thought of as leading

to a level playing field, since they do not give greater incentives to higher-cost technologies.

The difference between a FIT and a production subsidy is that a FIT sets the price paid for energy, while a production subsidy is added on top of the market price or regulated price. In other words, a FIT can substantially reduce market risks by disconnecting renewable energy from the market price of electricity. This means a FIT can be less risky than a production credit. A Uniform FIT is fairly similar to a carbon tax because it treats all renewable energy in a similar fashion. This means it does not provide far higher subsidy levels to projects that are far more costly. Consequently, it is reasonably efficient, although it cannot compensate for variations in (a) the value of power with different time profiles or (b) variations in the carbon content of the power replaced. It also will tend to underreward conservation.

This reduction in risk makes predicting the amount of renewable investment somewhat easier and hence should make planning transmission for that investment somewhat less risky. A uniform FIT can also simplify renewable transmission investments because it will encourage only the most economical technologies—many fewer than a standard FIT (described below). Lower risk benefits the transmission planner, but it also benefits renewable investors and consumers, both of which find the market risks associated with electricity prices costly.

#### 4.3.5. The Standard Feed-in Tariff

Feed-in tariffs typically “guarantee transmission service,” but usually fail to specify the meaning of this guarantee clearly. They do not specify whether the guarantee means providing the service regardless of the cost or how quickly the service must be provided. Sometimes this requirement even conflicts with preexisting transmission regulations. Besides such problems, this requirement makes proactive transmission planning more difficult. If transmission services need to be individually guaranteed to each FIT generator, inefficient solutions are likely to be picked. In addition, as explained in Part I of the report, such a reactive

approach could lead to implementation delays and less timely connection of generation providers.

Present-day feed-in tariffs are rarely uniform. Instead they set a different price for each type and scale of technology in a manner designed to make all of them break even—that is, be profitable, but without excess profits.<sup>6</sup> This concept is not well defined, because, for any technology, the break-even tariff will differ with location and other factors. For example, if a US\$100/MWh price makes a wind turbine in the location with the best wind resource break even, it will not be sufficient for wind turbines in other locations with poorer resources. Therefore, it will be impractical, if not impossible, to determine break even for any location.

The point is, however, that there is no one price that makes wind turbines break even. The higher the FIT tariff is set, the more renewable generation will prove to be profitable and the more will be built. Picking the “break-even price” could mean that only the best generator will break even, or that the tenth best will break even, or the one hundredth best, and so on. So when the designers of a FIT set a subsidy level for each technology at “the break-even level,” this provides little, if any, guidance for the transmission planner or transmission regulator. So the transmission planner must, instead, rely for guidance on the level of the FIT and attempt to predict from this level how much renewable generation will be built. However, this level may change long before transmission can be built if the resulting level of renewable investment proves to be too far from the goal of the FIT designer, as has sometimes happened.

It would be helpful for transmission planning if the FIT’s target investment level were explicitly announced, along with an assurance that the FIT would be adjusted to achieve that target. Transmission planners would then know how much generation to plan for.

When FITs vary for each technology, planners can still attempt to implement anticipatory planning. See, for instance, the cost reduction method of grouping requests used in the case of Brazil and the Philippines presented in Chapter 3, both of which can be

<sup>6</sup> It is claimed that “[a] feed-in tariff drives market growth by providing developers long-term purchase agreements for the sale of electricity generated from RE sources. These purchase agreements, which aim to be both effective and cost-efficient... Cost-efficient refers to offering per-kWh payment levels that are sufficient to cover project costs, while allowing for a reasonable return” (Couture, Cory, and Kreyckik 2010). Of course, it should be remembered that *cost-efficient* does not mean this, but the mis-definition is required to explain how a FIT is structured.

implemented under a FIT scheme. A step forward would be for planners to follow the transmission-generation trade-off by checking that only transmission that is worth a predetermined, uniform, value for renewable energy is built. This concept will be presented in Section 4.4.

#### 4.3.6. The Renewable Portfolio Standard

An Renewable Portfolio Standard (RPS) is a quantity-based approach. Under an RPS, utilities are typically required to buy a certain number of renewable energy credits (RECs), also called renewable energy certificates. These can only be supplied by renewable generators. Such programs have been adopted widely in the United States, but they differ in every state, and the rules for trading RECs are quite complex.<sup>7</sup> Since a large number of technology types can supply RECs and since 1 MWh of RECs is worth the same amount no matter what technology generates it, this creates a level playing field among the major renewable technologies, at least within each state. In this sense, an RPS is akin to a uniform production subsidy or a Uniform FIT.

The value of selling RECs adds to the value of selling electricity, so in that sense, it is like a production credit. In the long term, however, if the price of electricity increases, the price of RECs should decrease, which would tend to stabilize the total payment to renewable electricity the way a FIT does. However, the price of RECs tends to be quite volatile because of the inelasticity of both the supply and demand for RECs, so the REC price does not provide anything like the risk reduction a FIT can provide. The unpredictable of REC prices not only imposes a high risk premium on renewable generators, but seems to make the achievement of RPSs unpredictable. If the penalties for missing these standards were sufficient, the standards would be complied with.

A quantity target makes transmission planning much easier by facilitating transmission solutions that are more accurate. A planner would select renewable energy projects to minimize generation and transmission costs as the target is gradually achieved. This is the case with the process to launch auctions as-needed for certain quantities of renewable energy

in Brazil, as explained in Chapter 3. A quantity-like target facilitates selecting projects whose combined generation and transmission costs are lower. In the case of Brazil, the energy price is determined in an auction where transmission costs have been previously minimized for potential winners of the energy auction. If a particular energy provider is not competitive because its combined generation and transmission costs are not competitive, the auction will not award it a contract. This leads to a solution that is closer to the efficient benchmark.

If RECs are traded over a wide area and targets can be met with resources from other jurisdictions (for example, states or countries), transmission planning can still be handled in a way that efficient outcomes are pursued, but the outcome will be less accurate. While planning across borders is a more complex task, the emerging experience in the Midwest ISO presented in Chapter 3 is an example of how state quantity targets facilitate the analysis of recommending least-cost transmission solutions that will be required to achieve such targets.

While transmission planning is better facilitated by some subsidy policies (RPS) than by others (FIT), the main principle to follow remains the same. The total cost of generation and transmission should be minimized. The process of doing this is called the basic trade-off. The next section describes this trade-off, which is the basis for all the other principles recommended in this report.

#### 4.4. The Generation-Transmission Basic Trade-Off

The trade-off between the cost of generation and the cost of transmission is a standard one, and for renewable transmission, it is the key to good transmission planning. In this report, it is a central focus of Part II and will be called the basic trade-off. One way to understand this trade-off and to make it efficient is to view transmission as a source of renewable power. This is not literally the case, but it helps focus attention on the value of transmission, and it is equivalent to the standard least-cost approach. From this perspective, changes in generation costs are summarized as the amount and value of renewable energy “produced” by transmission.

<sup>7</sup> RPS subsidies have also been implemented in other countries.

#### 4.4.1. Viewing Transmission as a Renewable Power Source

The same renewable generator may have quite different costs per megawatt-hour if placed in different locations. Because of this, it may be cost effective to build longer, more-expensive transmission. But how much is it worth paying for the extra transmission? To answer this question, it is useful to change perspectives. Transmission itself can be viewed as a source of energy. From this perspective, the trade-off question has a simple answer: the final stretch of transmission should cost no more than the value of the renewable energy it produces.

Consider an example showing how this perspective will be used. Suppose a generator—perhaps a wind farm or solar array—will produce 100 MW on average if located on the present system, but if located remotely, it will produce 120 MW on average. (Box 4.3 describes the unit system that will be used throughout this part of the report.) However, this requires a transmission line. In this case, we can think of that line

as producing the extra 20 MW and ask how much the extra power will cost. Its cost is clearly the cost of the line. Suppose the levelized cost of the transmission line is US\$5/MWh. Since the line transmits 120 MW of renewable power, that comes to US\$600 per hour ( $120 \text{ MW} \times \text{US}\$5/\text{MWh}$ ). So the extra 20 MW ( $120 \text{ MW} - 100 \text{ MW}$ ) that the line produces costs US\$600 per hour. That comes to US\$30/MWh ( $\text{US}\$600/\text{h}$  divided by  $\text{US}\$20 \text{ MW}$ ). If this is less than the value of renewable power (as it may be), producing renewable power with the transmission line is a good idea, and it should be built—at least if there is not an even better alternative.

Renewable energy is worth more than nonrenewable system energy. So in order to evaluate transmission for renewable generation, it is necessary to have a *value* for renewable energy. This will be discussed shortly, but first we consider the *cost* of transmission-produced energy in more detail.

#### 4.4.2. Finding the Cost of Renewable Power Produced by a Transmission Line

To find the benefit of a transmission line, the output of generators at the remote end of the line must be compared with their output at some other point. The point at which the remote transmission line departs from the system may be particularly inappropriate for renewable energy production, so comparing the remote location to that poor location would not be a fair comparison. Instead, for mathematical convenience, it is best to pick a sight where the renewable generator would just break even, given the price paid for renewable energy.<sup>8</sup> And since there will be many of these, the one with the lowest transmission costs should be chosen. This will be called the best break-even site (BBS).<sup>9</sup> Producing at the BBS might require internal (deep system) upgrades, and these should be included in the cost of generation when determining the (cheapest) BBS for renewable generation.

We can now write down the formula for the quantity and cost of renewable energy produced by renewable transmission. but first, we must define some variables:

##### Box 4.3: An Important Note on Measuring the Cost of Transmission

It will be useful in this analysis to compare transmission costs and energy costs. This can be done most conveniently by **measuring both in \$/MWh**.

Although the cost of a generator is often stated as a cost measured in \$/MW, it is common practice to reduce this to an amortized (levelized) cost per year, which is then measured in \$/MW-year. If this value wresult is a levelized cost in \$/MWh.

Similarly, the cost of a transmission line can be amortized (levelized) and stated as a cost per year. This can be divided by the energy, in MWh, it transmits annually to find an average cost in \$/MWh.

**Throughout Part II, generation and transmission capacity, as well as power, are measured in MW. Energy is measured in MWh and all costs in \$/MWh.**

<sup>8</sup> Renewable generation will not deliberately be built at worse sites, and generally will be built at better sites.

<sup>9</sup> This concept is quite similar to the “comparator projects” used to evaluate transmission to and projects on the Scottish Islands of Shetland, Orkney, and Western Isles. The comparator projects are “on the mainland situated in relatively close proximity to the islands” (IPA Energy 2008). Choosing a site that differs somewhat from the true BBS will not result in a larger error because it will shift all transmission benefits up or down by a similar (though not identical amount).



$K$  = the MW capacity at both the remote and BBS.  
 $C$  = the cost of  $K$  in \$/MWh.

$f_R$  = the capacity factor at the remote site.  
 $Q_R$  = the average MW power output at the remote location ( $f_R \cdot K$ ).  
 $C_R$  = the cost of producing  $Q_R$  per MWh  
 (=  $C K/Q_R = C/f_R$ ).

$f_B$  = the capacity factor at the BBS.  
 $Q_B$  = the average MW output from  $K$  at the BBS ( $f_B \cdot K$ ).  
 $C_B$  = the cost per MWh of producing  $Q_B$  per MWh  
 (=  $C K/Q_B = C/f_B$ ).

$Q_T = Q_R - Q_B$  = the average MW output produced by the transmission line.  
 $C_{QT}$  = the cost per MWh of producing  $Q_T$ .  
 $C_T$  = the cost per MWh of transmitting  $Q_R$  over the new remote transmission line.

In this analysis, transmission increases the output of renewable energy by increasing the capacity factor of the renewable generators, but the generating capacity itself does not change. It only moves to a more favorable (remote) location. In reality, the move could change other cost factors as well, and this is treated in Chapter 4. The current analysis, however, captures only the main effect—a change in capacity factor, which changes the average output from  $Q_B = f_B \cdot K$  at the BBS to  $Q_R = f_R \cdot K$  at the remote location. Solving for  $K$  at the remote site and substituting that for  $K$  at the BBS gives  $Q_B = (f_B/f_R)Q_R$ , which says that less is produced at the BBS if  $f_B > f_R$ , as expected. So the average output of renewable energy produced by transmission equals

$$Q_T = Q_R - Q_B = Q_R (1 - f_B / f_R) \tag{1}$$

[measured in MW]

Note that the cost of renewable energy equals the cost of capacity,  $C \cdot K$ , divided by the amount of power produced,  $f K$ , or  $C/f$ . So, the cost of renewable energy is inversely proportional to  $f$ . This leads to another version of equation (1):

$$Q_T = Q_R - Q_B = Q_R (1 - C_R / C_B) \tag{1a}$$

[measured in MW]

This version holds more generally than under the present restriction that only the capacity factor is affected by location. However, when location affects

other cost factors, the calculation of cost involves complexities that are described in the next two chapters. In any case, the cost,  $C_{QT}$ , of renewable energy produced by this remote transmission is

$$C_{QT} = C_T \cdot Q_R / Q_T \text{ [measured in US$/MWh]} \tag{2}$$

This can be understood by example. Suppose the cost of transmission is US\$10/MWh, and it is transmitting 100 MW on average. This is a cost of  $C_T \times Q_R =$  US\$1,000/h. However, if it is only “producing” 25 MW, it is costing US\$1,000/h to obtain these extra 25 MW, so the cost is (US\$1,000/h)/(25 MW) = US\$40/MWh. In the previous example, transmission costs US\$5/MW for 120 MW, but only 20 MW was produced by the line, so that comes to  $5 \times 120 / 20 =$  US\$30/MWh, just as before. Note that as  $Q_T$  approaches zero, the benefit of the line approaches zero and so the cost per megawatt-hour produced approaches infinity.

In general, it will be necessary to specify a value for renewable energy, and we will denote this by  $V$ . This value should be the value of nonrenewable energy plus the value of reduced carbon emissions plus the value of fuel diversity. This value may vary somewhat by source for two reasons. First, electricity varies in value quite dramatically with the time of day, week, and year. So, for example, disregarding externalities, wind power may be considerably less valuable than solar power because wind power tends to be slightly greater at night when the value of electric power is low, while solar power peaks in mid day when the value of electricity is greatest. Second, different types of renewable energy may replace electricity with different fossil or carbon content. Although this varies significantly by time of day, it may vary even more by location, depending on the types of generation that are prevalent in various locations and the geographic extent of the transmission system.

Once the value,  $V$ , of renewable energy has been determined and the cost,  $C_{QT}$ , of the renewable power produced by the transmission has been determined, we have an indication of whether the line should be built:

If  $C_{QT} < V$ , then the renewable transmission should be built. That is, the remote source should be connected.

Of course, it should not be built if there is a better way to serve the same purpose. Because there are many uncertainties in transmission planning, the values of  $C_{QT}$  and  $V$  need not be determined with precision,

but estimating their values should provide a good check on the economics of transmission projects under consideration.

#### 4.4.3. Using the Value, *V*, of Renewable Energy to Solve the Generation-Transmission Trade-Off

Renewable generation subsidies have evolved into systems that subsidize zero-carbon electricity differently, depending on the technology that generates it. This is most extreme in the case of FITs, but many RPS policies now use “carve-outs,” which have the same effect. These multisubsidy approaches present transmission providers with a paradoxical situation. The source of the seeming paradox is the apparent ambiguity in the value of renewable energy when some of it has a high cost of production and some a low cost of production.

##### 4.4.3.1. An Example of the Multisubsidy Paradox in Transmission Planning

Consider a solar PV generator that can produce power at a cost of US\$400/MWh in a good location. Suppose, however, that this location requires US\$20/MWh transmission, so the full cost is US\$420/MWh, but the same solar array could be built at the BBS. In this location, its output will be only 900 MW instead of 1,000 MW. This information is presented in Table 4.1.

Note that the levelized cost of generation shown in Table 4.1 is the same at the BBS and at the remote site. The question we wish to answer is a fundamental one for transmission planners. Should this transmission

be built? If the answer is yes, its carrying costs will be US\$20,000/h, or US\$20/MWh. The result will be the delivery of 1,000 MW instead of 900 MW of solar power to the grid. So to make the question concrete, is the extra 100 MW of solar power worth US\$20,000/h?

The answer, of course, depends on the value of the solar power. First note that since delivering the extra 100 MW costs US\$20,000/h, the extra power is costing us US\$200/MWh. Assuming the renewable policymaker is willing to pay US\$400/MWh to generate solar power, one could assume this value is the social benefit. So at a cost of US\$200/MWh it is worth expanding transmission to a remote site that yields extra energy at lower cost than the social benefit of renewable energy (US\$400/MWh). Since the remote site is worth exploring, it would also be a better alternative than the local site (BBS), since it yields 1,000 MW at a cost of US\$420/MWh as compared with 900 MW at a cost of \$444/MWh.

To illustrate the multi-subsidy paradox, suppose wind generators can produce power for a price of US\$125/MWh. That would indicate that the renewable energy could be worth only US\$125/MWh (or possibly less), so there is no use in paying US\$200/MWh for it. In this case, the transmission should not be built. The apparent contradiction between these two answers is the multisubsidy paradox. The two different subsidies seem to imply two different values for identical renewable power.<sup>10</sup> We assume, for explanation purposes, that the different subsidy policy is not self-contradictory.<sup>11</sup>

To resolve the paradox, it is necessary to take a close look at the rationale for a multisubsidy policy. Looking at the literature on FITs, one finds that a frequent objective is the motivation to be a key player in the market for a particular new technology, say, photovoltaic technology, and to contribute to cost reduction. For this reason, a country may be willing to pay a high subsidy for purchasing PV arrays.

We can continue using our example to resolve the paradox. Assuming that the high subsidy rate for solar PV is not simply a contradictory valuation for renewable power, we can conclude the solar PV power is worth the same as wind power and that the extra subsidy is a subsidy for solar PV manufacturers to achieve other

	<b>BBS</b>	<b>Remote site</b>
Average power generated	900 MW	1,000 MW
Levelized cost of generation	\$400,000/h	\$400,000/h
Total cost of transmission	\$0/h	\$20,000/h
<b>Total cost of energy</b>	<b>\$400,000/h</b>	<b>\$420,000/h</b>
<b>Energy cost per MWh</b>	<b>\$444/MWh</b>	<b>\$420/MWh</b>

<sup>10</sup> There are, in fact, some differences between wind power and solar power, primarily related to predictability and time of day. However, this is not the reason for the difference in subsidies, so if the power were identical, the example would still hold. For simplicity's sake, we assume it is identical.

<sup>11</sup> As already noted, standard economics argues for a single price of the externality.

objectives described in the previous paragraph. For simplicity, we will assume that the subsidy for wind power contains no such manufacturer subsidy, and so the US\$125/MWh paid for wind power reflects the value of the power itself. In other words, the true value of renewable energy,  $V$ , is US\$125/MWh.

Once we separate out the cost and output effect of the remote transmission, the resolution of the paradox becomes clear. The transmission results in an additional 100 MW of renewable power and costs US\$20,000 per hour. So the renewable power produced by the transmission costs US\$200/MWh, but this is more than the US\$125/MWh value of renewable energy. So the transmission should not be built, since there is a cheaper alternative. This is the correct resolution to the paradox. Transmission should be built to the extent that it accesses renewable generation below the renewable energy value.

A price of US\$400/MWh for solar PV power is explained, since it contains a two-part subsidy, one for the power produced itself and the other to help solar PV manufacturers achieve other industry development objectives. Building transmission to connect the remote solar site does not help PV manufacturing at efficient costs in our example. The example illustrates that expanding transmission at the price paid for different technologies cannot be used to determine whether transmission should be built. Crediting the extra energy resulting from the transmission in the example as being worth US\$400/MWh would make the transmission appear cost-effective, although it is not. That is, any renewable subsidy that is greater than the value of renewable energy should not serve as a reason to build more transmission. The extra subsidy is intended to induce the purchase of more renewable technology and not the purchase of more transmission.

This way of viewing the transmission planning problem is helpful, given the complexity of FITs and all of the many complex renewable subsidy policies. The transmission planner may have to look to these when estimating how much renewable generation will be built, but once that estimate is made, transmission planning should not take into account these different subsidy rates. Instead the planner need only take account of three things: (a) the cost of transmission; (b) the increase in renewable output transmission achieves; and (c) the value,  $V$ , of renewable energy.

#### 4.4.4. Obtaining an Estimate of the Value, $V$ , of Renewable Energy

The policy maker that sets renewable subsidies should do so based, at least partly, on the value of renewable energy. In fact, for FITs, as discussed above, the tariff is apparently related to  $V$  as follows:

$$\text{FIT Price(energy type } T) = V + (\text{subsidy to manufacturer type } T) \quad (3)$$

In other words, there are two named reasons for subsidizing a particular type of renewable energy: first, because all renewable energy reduces certain negative externalities, and second, because subsidizing a particular type of energy helps the manufacturers of the generators of that type of energy to achieve perhaps other objectives. Equation (3) provides two insights. First, since the policy makers are setting FIT prices to the sum of  $V$  and another subsidy, they should have some idea of the value of  $V$ ; otherwise, they could not determine the appropriate sum. Second, equation (3) indicates that

$$V \leq \text{FIT Price(energy type } T), \quad (4)$$

for all energy types,  $T$ . So the lowest FIT puts an upper limit on  $V$ .

Because of this close connection between renewable energy subsidies and the value of  $V$ , it is clearly the role of the renewable policy maker, and not the role of the transmission provider, to estimate  $V$ . However, the transmission provider does have a strong interest in obtaining a value for  $V$  from the renewable policymaker, because this value is essential to making reasonable and defensible decisions on what transmission to build for renewable energy projects.

Determining  $V$  can be a difficult problem, but there are several alternatives. For instance, there is a vast body of literature (see, for instance, Octaviano 2010) and actual practical applications on determining local externality costs of renewable energy, which can be used to determine the social cost of power and, therefore, a value for renewable energy. These values could easily be applied in any region simply by finding the cost of electricity production from coal, oil, and gas, and their share of production. An example of such a calculation is shown in Table 4.2.

**Table 4.2: Estimating the Value of Renewable Energy**

Fuel	Private cost per MWh (US\$)	Externality adder (%)	Social cost per MW (US\$)	Share of output (%)	Contribution to social cost (US\$/MWh)
Coal	105	100	205	40	82
Oil	140	100	380	10	38
Gas	100	30	130	20	26
Other	60	0	60	20	12
Total social cost of current system power, $V = 158$					

Source: Private costs of new coal and gas generation built in 2016 are estimated from U.S. DOE (2010b) data.

Note that this value for renewable energy will only be used to calculate the value of renewable energy produced by transmission. Even using such off-the-shelf standardized externality adders should provide an estimate of  $V$  that is much better than using no estimate at all.<sup>12</sup> Without such an estimate, the planner is likely to make inconsistent decisions that would not be appropriate with any value of  $V$ . Or, the planner, because of inadequate knowledge, may implicitly choose to employ a far less appropriate value of  $V$ .

One final look at estimating  $V$  may be helpful. The first step is to note that  $V$  has two parts:

$$V = (\text{value of nonrenewable energy}) + (\text{value of reducing externalities}) \quad (5)$$

Fortunately, the value of nonrenewable energy is likely to be at least as large as the externalities part of  $V$  for some time to come, so the bulk of the estimate is made fairly easily. If  $V$  is mainly based on climate policy, then perhaps the externality part of  $V$  should be set at the global price of carbon emissions. Although this is not well established, there is a price for U.N. CERs, and there is a price for European carbon credits (EUAs), as well as a price for the Assigned Amount Units (AAUs)

of the United Nations. Suppose a developing country decides that one of these is a good benchmark and selects, say, a €30/ton price of carbon. Then, in a power system that emits on average 2/3 of a tonne of CO<sub>2</sub> per MWh generated, renewable energy would be valued at US\$20/MWh more than the average price of nonrenewable energy.

Alternatively, if it is found that 10,000 GWh per year of renewable energy would reduce the risk of fossil fuel costs by US\$300 million per year, 1 MWh of renewable energy would be worth US\$30/MWh more than the average price of wholesale power. And if both calculations were applicable, then renewable energy would be worth US\$50/MWh more than the wholesale cost of power in the country in question.

There may be other methods of valuing renewable energy and other reasons that renewable energy may be valuable, but it is important to consider only the reasons for which the energy itself is valuable. The policy maker setting subsidies for renewable power should be the one to take these considerations into account. Disclosing this value to the transmission planner is essential to make sure the planner makes more efficient decisions.

<sup>12</sup> It should be noted, however, that the cost of externalities are not, in fact, related to the cost of fossil fuel, as assumed by these factors.

## 5. ECONOMIC PRINCIPLES ON TRANSMISSION PLANNING

Each section of this chapter explains one problem and draws a conclusion about the main principle that should be used to solve it. These principles are presented in the order in which they are needed to develop a transmission planning framework. It may be helpful to start with an overview of that framework. This does not include any implementation details, which will be numerous. It is only meant to provide a clear view of how the principles work together.

First, the basic trade-off between the cost of transmission and the productivity of renewable generators is reviewed. Because transmission is less costly when compared with generation, and because renewable resources vary dramatically with location, this trade-off often favors building more than the minimum transmission. This can happen in two ways. Most simply, the transmission provider can provide access to renewable generators wherever they locate. This is called reactive transmission planning. Unfortunately, this will not produce renewable energy at least cost, and may cause waste. A better approach is for the provider to plan transmission proactively.<sup>13</sup> This will result in a lower total cost of renewable energy and will provide transmission for renewable generators in a more timely fashion.

If transmission is planned reactively, it is still important for the provider to minimize the cost of providing transmission. In this case, however, there will be no concern with the effect of transmission on the cost or productivity of renewable generation, so the problem is relatively straightforward. However, when transmission is planned proactively, the transmission provider must calculate the costs and benefits of the basic trade-off and maximize net benefit.

### 5.1. The Cost-Effectiveness of Extra Transmission

As more generation is added to a power system, the transmission grid must be expanded to handle the power it delivers. And sometimes, for example, with large new hydroelectric projects, long new power lines must be built. The U.S. Department of Energy (U.S. DOE

2010b) estimates that an increase in hydropower in 2016 will require US\$5.70/MWh of new transmission. New coal plants (if any are built) would require US\$3.60/MWh. New wind power will require US\$8.40/MWh, and new solar PV will require US\$13/MWh.<sup>14</sup>

While these costs are substantial, as Box 5.1 shows, the benefits of locating renewable generation in areas with higher-quality resources can easily be even greater. In other words, transmission increases output, just as if it were producing renewable energy itself, by moving generators to where there is a better renewable energy resource.

This renewable power that is, in effect, produced by the additional transmission should be compared to the cost of that transmission. When this is done, it will often be found that additional transmission produces renewable energy more cost-effectively than any other technology.

Any policy that seeks cost reduction is preferable; it will have other positive impacts on aspects, such as affordability. Affordability of renewable energy, and any other costs such as transmission, is something that policy makers should consider when implementing any policy. However, any policy that does not seek reduction will further negatively affect affordability. Funding options are always limited, which in turn must limit how much renewable energy can be afforded. The energy, however, should always be produced as cheaply as possible. This means building all the transmission that saves money and that is effectively used, but not more than that.

#### 5.1.1. Defining the Benefit of a Better Renewable Sources

The basic trade-off requires knowing how much more renewable energy will be produced if a renewable generator is moved to a remote location that becomes accessible with additional transmission. There are some subtleties to this question because a different generator design may be appropriate in the remote location. In addition, the best local design must be compared with the best remote design if the comparison is to be fair. For example, some wind turbines are better for low wind speeds, and some are better for high wind speeds.

<sup>13</sup> Note that this is not an argument in favor of planning instead of a market-based approach. Both approaches are planning approaches. The point is to plan thoughtfully instead of making ad hoc, last-minute plans. Of course, thoughtful planning can still go astray, and it is important not to assume too much is known about the future.

<sup>14</sup> Baldick (2010) estimates that US\$20/MWh is needed for transmission for wind energy in Texas.

### Box 5.1: Example of the Basic Trade-Off: Why Building More Transmission Can Easily Save Money

According to the U.S. Department of Energy (US DOE 2010b), in 2016, wind energy will cost US\$150/MWh, of which US\$5/MWh will cover the cost of extra transmission needed to reach locations with better wind resources. So a 3.3 percent increase in wind power will pay for the extra transmission cost.

Because wind power increases with the cube of the wind speed, a 1.5 percent increase in wind speed will generate about 4.5 percent more power—more than enough to cover the cost of the extra transmission. This is such a small increase in wind speed that it seems certain that the US\$5/MWh cost will have been much more than paid for by the improved wind resources it provides access to.

Of course, the U.S. DOE values may be optimistic, and the value for renewable energy can be less than its cost. Suppose wind energy has a value of only US\$100/MWh, and transmission to a windier location costs US\$20/MWh. This is a pessimistic scenario. In this case, if the wind were 7 percent stronger, it would impart 22 percent more power to the same wind turbine. If the wind turbine could make use of this extra power, the extra power “produced” by the transmission would cost less than US\$100/MWh, and so the transmission would be worthwhile. A 7 percent improvement in wind speed, say, from 25 kilometers per hour to 27, is not much to ask for from transmission costing so much.

So even in this pessimistic scenario, it seems that the transmission could easily save money by reducing the total cost of generation and transmission per megawatt-hour generated.

Similarly, a solar array may be more difficult to install in one location than another, so the installed cost may vary.

The precise question that will need an answer is how the ratio of output to generation will cause changes between the local and remote locations. These considerations will need to feed into the calculation of *QB*, *QR*, *CL*, and *CR*, as defined in Chapter 4.

The increased output needed to justify even a very expensive transmission project is fairly small. An accurate estimate deserves to be made in each individual case, but in general it should be worth building wind and solar generators where the renewable resource is excellent, even if this requires long transmission lines. Exceptions could happen in offshore generation where costs can be much greater.<sup>15</sup> While offshore generally provides much better wind resources, the cost of generation itself is much higher. So this is a case where both the cost and output of generation vary, and the increased cost may outweigh the increase in output. Detailed analysis should be undertaken to determine the answer.

Sometimes the basic trade-off has been ignored. This may be partly attributable to the frequent use

of peak capacity to measure success. Peak capacity rather than output is often used to measure both the cost and the magnitude of renewable generation. A wind farm with a peak capacity of 100 MW may well have an average output of only 30 MW. In addition, extra transmission will not increase capacity, and the cost of transmission will only increase the total cost per megawatt of installed capacity. Instead, whenever policy analysis is undertaken, renewable generation should be measured in terms of energy produced. This will focus attention on the critical importance of good locations and the need for good transmission planning.<sup>16</sup>

### 5.2. Developing Transmission Proactively

FITs often include “guaranteed transmission access.” While this is intended to be exceptionally supportive, it can actually make high-quality renewable investment more difficult and result in less investment and poorer-quality investment. We first discuss the source of these difficulties and then suggest that proactive transmission development is a better principle than the poorly defined “guaranteed-access” provision frequently found in standard FITs.

<sup>15</sup> According to U.S. DOE (2010a), offshore wind costs an extra US\$40/MWh, but this may be paid for by the higher capacity factor.

<sup>16</sup> “While the goal level was based on a capacity value (MW), in implementing the program the \*Texas+ PUC very intelligently decided that the system must use energy values (MWh) in order to function effectively” (Diffen 2009).

### 5.2.1. Reactive Transmission Investment

Guaranteed transmission access is the best transmission policy from the perspective of the renewable energy provider, but this policy has a built-in problem.<sup>17</sup> Access sounds like it is just a matter of allowing a renewable generator to connect, but the best renewable sites are most often in places where there is no transmission to connect to. So the only way to implement such a guarantee is to wait until investors have made a firm decision and then to build transmission for them. But since transmission often takes much longer to build than it takes to build renewable generators—especially wind turbines—this leaves the investor waiting, possibly for years, for the guarantee to be fulfilled. This discourages renewable investment in many of the best locations. Instead, investors will tend to build where transmission already exists, so they can be sure of timely access to transmission. The locations with ready transmission, however, may not often be the best locations.

### 5.2.2. Anticipatory Transmission Investment

Without proactive planning, it is still possible to plan transmission more economically than under the purely reactive approach. This can be done by either anticipating where generators will locate or by postponing investment decisions until there is a sizable backlog of renewable generators seeking connection. Both of these approaches will be referred to as “anticipatory.” Although the wait-and-see approach might be considered a bit like anticipating the past, the two approaches have much in common and are both in between the purely reactive and the purely proactive approaches.

A creative transmission provider can improve a reactive planning situation by anticipating where future generation providers will wish to locate. This is illustrated in Figure 5.1.

Figure 5.1 shows a remote line built to the first committed renewable generator, E. Notice, however, that the line does not take the shortest route. The purpose of such a line is to anticipate other renewable generators that will likely locate at sites A through D. In fact, building the line in this manner makes it highly likely that investors will build at these sites, because they

**Figure 5.1: Anticipatory Transmission Planning**

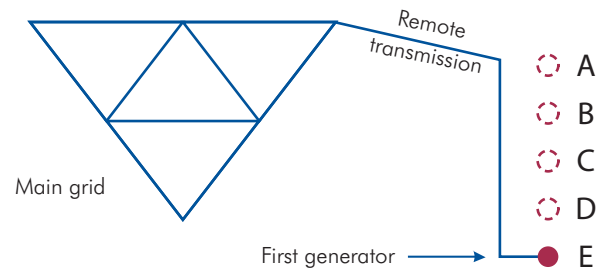

Source: The authors.

will be assured of being connected to the grid quickly. In this sense, the longer, more expensive line is somewhat proactive—it serves to guide generation investment.

Although this approach may guide generation investments into clusters, it will not do much if anything to improve the basic trade-off, so it can only be considered minimally proactive. Such an innovative transmission plan, and one that is not called for by “guaranteed access,” may be a risk for the transmission provider. In addition, the provider may have little or no motivation to be innovative in this way. Nonetheless, if a transmission provider has the approval of its regulator, it may be able to be somewhat anticipatory in its provision of transmission, in spite of the way a FIT is designed.

A safer approach for the transmission provider is to first accumulate a number of generation applications for connection. In the above example, the provider might wait for generators A–E to all apply for connection. This is the approach already taken in Brazil, Mexico, or California in the United States where groups of projects are treated altogether to reduce transmission costs. This requires organizing the transmission planning process in batches and not necessarily guaranteeing immediate access on an individual basis, which could lead to a more costly solution. See Chapter 3 with numerical examples from the studies performed by the World Bank for the Philippines (World Bank 2010b).

By waiting for a large number of applications for connection before planning the lines, the provider can group the generators and then build fewer lines that are planned more efficiently. This might be called wait-

<sup>17</sup> We assume that access means the obligation of the transmission company to provide transmission services, regardless of the cost of such services, to consumers (assuming consumers will pay all of it at some point in the future).

and-see anticipatory planning, but it has the advantage of being more accurate, although slower, than genuine anticipatory planning.

Notice that the optimization problem for either a reactive or an anticipatory transmission provider is simply to minimize transmission costs, taking the location of generators as given. This means that neither type of transmission planner engages in the basic trade-off between the cost of generation and transmission. If it is known that renewable transmission will definitely be built at sites A–D eventually, the line shown in Figure 5.1 is simply a clever way to minimize transmission costs by anticipating future generation projects. However, the sites for these projects may be poorly chosen because generation investors have no reason to make the basic trade-off wisely, since they are guaranteed transmission.

### 5.2.3. Proactive Transmission Planning

Proactive transmission planning solves the “chicken and egg problem” for renewable development. The problem is that transmission providers do not wish to start building a line until generation developers have committed to using it, and developers do not wish to commit until transmission access is assured in the near future. Proactive planning can also speed up transmission access compared with the wait-and-see version of anticipatory planning, or a purely reactive approach. Finally, because it optimizes the basic trade-off, it will generally provide more efficient solutions and cheaper renewable energy.

A fully proactive investment policy is at the opposite extreme from a purely reactive policy. Under a proactive policy, the transmission provider will plan and build transmission without taking any account the specific plans of individual generation investors. This does not mean that the transmission provider ignores the needs and profitability of generation investors—far from it—but what the transmission provider takes into account is the set of conditions faced by investors in general and not the actions of specific investors.

This is, of course, how transmission planning is done by vertically integrated utilities. In these, there are no independent decisions by generators requesting guaranteed access regardless of the location. Instead, the utility considers the full optimization problem and minimizes the combined cost of generation and

transmission. As will be seen shortly, the planning principle used by integrated utilities carries over to a setting with a transmission planner and competitive, independent power producers. So the recommendation for proactive transmission planning principle will be the same, from a technical point of view, since the old vertically integrated planning principle—updated, of course, with a new value for renewable energy.

There is, however, a compromise proactive approach that can be used; something related to this is in fact used in Texas (see Chapter 3). The planner can collect data on renewable resources and make estimates of transmission costs to the various regions with good resources and then check the financial commitment level of generators in the various regions. If generators know they will be required to pay the bulk of the transmission cost, they will make their commitments on the basis of optimizing the basic trade-off. This harnesses some of the knowledge of investors to help make the transmission planner optimize the basic trade-off. Of course, the investors will not coordinate well, so the planner will still need to select the regions that seem most popular and focus its transmission plan on those regions.

This shows that various approaches to proactive transmission investment are possible. They will not all be optimal, but what makes them proactive are two features:

1. The transmission planner attempts to improve the basic trade-off.
2. The transmission planner guides the location of generation investments.

There is no presumption in this definition that the plan will be optimal or that it will follow the procedures described below. The second feature actually follows from the first. In Texas, switching to a proactive approach that follows these two principles is apparently having a very beneficial effect on renewable generators. Under a reactive approach, “most Texas wind farms have been built in regions that have only a marginal wind resource as opposed to the good wind resource areas” (Diffen 2009). Under the new proactive CREZ approach, however, “the goal of the CREZ process is to build transmission to where the best wind resource is located.”

Although a proactive approach is defined by its qualitative characteristics, it makes sense, as a next step, to ask what conditions would be met by an optimal proactive approach. Specifically, the provider



should attempt to minimize the combined cost of transmission and generation for any given amount of renewable energy supplied by the system as a whole. However, minimizing the combined cost of transmission and generation when the provider has direct control of only transmission costs, and no direct control over generation investment, requires a well-thought-out approach and transmission pricing. This is discussed next and in the following chapter, respectively.

### 5.3. Maximize the Net Benefit of Renewable Transmission

The planner should plan for transmission as if it could minimize generation, as well as transmission cost. The goal of a well-designed power system should be to minimize the total cost of serving load—the total cost of transmission and generation. This view is complicated by the introduction of subsidies for renewables, which constitute an additional cost. However, if we introduce the cost of subsidies, we should also introduce the cost of the negative externalities associated with fossil fuel. Doing this simplifies the cost-minimization problem, provided that the subsidies are set correctly. For now we assume that they are.<sup>18</sup>

As explained in the previous chapter, renewable transmission brings a net benefit if its cost is less than the value of the renewable energy it produces. Normally the transmission planner would only need to consider nonrenewable system energy, which has a lower value. With renewable energy in the mix, however, the planner must also use the value,  $V$ , of renewable energy produced by transmission.

Next we must solve a puzzle for the transmission planner. A proactive planner should minimize the total cost of generation and transmission. The planner has control over what transmission is built, but not over generation. So what should the planner assume regarding generation when it plans transmission?

Consider, for a moment, a hypothetical system in which both transmission and generation are supplied by competitive markets. While not realistic, it is a helpful setting to consider. There is nothing unusual

in having two complementary goods supplied by different industries, for example, auto makers and steel manufacturers. (The auto makers are analogous to generators; they require steel the way generators require wires.) So we can expect the normal economic results for competitive markets to apply in our hypothetical competitive market for generation and transmission. In a competitive market, the competitive transmission providers would supply and price transmission without having any direct control over the generation suppliers. In spite of this, both transmission and generation would be optimized by the market’s price signals, and the total cost of production would be minimized. There is no need for a central planner to coordinate investment in the two types of assets. In a competitive market, that coordination is supplied by transmission pricing and by the way generation investors respond to it with their investment and dispatch decisions.

Because of network externalities, it is presently not possible to have a competitive market for building transmission. However, the economics of a competitive market teach an important lesson. If the transmission planner builds and prices its transmission as if it were in the hypothetical competitive market just discussed, a competitive power generation industry will build the cost-minimizing generation—just as if it were in that same hypothetical competitive market. The transmission location and prices will send the proper locational signals to the generation developers, but how should the transmission provider know what transmission would be built in this hypothetical competitive market, and what prices are competitive transmission prices? How does a transmission provider mimic what it would do in our hypothetical market?

The answer is reassuring. To build the competitive lines, all the transmission provider needs to do is to reduce costs as much as possible—in other words, minimize the production and delivery cost of energy to consumers. It also needs to set competitive prices, but there is a helpful theory of competitive transmission pricing, which is discussed in the next section.

Building lines to minimize the total cost of delivered electricity is the same as building the lines that a

<sup>18</sup> The correct subsidy for a megawatt-hour of renewable energy equals the reduction in the cost of the negative externality caused by the generated renewable energy. With this subsidy, when the subsidy costs increase by €1, the negative-externality cost decreases by €1. As a consequence, with accurately-set subsidies, the costs of subsidies and externalities simply cancel out, and the transmission planner can treat the cost minimization problem in the normal fashion—it can ignore the cost of subsidies and externalities.

competitive market would build. This follows from standard economic theory that shows that truly competitive markets minimize total cost. There is only one way to minimize cost.<sup>19</sup> So if the transmission provider seeks a minimum-cost plan, it will automatically be guided toward the competitive outcome. It must, however, remember that a competitive market minimizes the total cost of transmission *and* generation, so the transmission provider must attempt to minimize that same total cost, and not just the cost of transmission. In other words, the transmission provider must try to make the basic trade-off in the least-cost manner.

### 5.3.1. The Need Planning and for Pricing of Transmission

Planning by itself does not guarantee a perfect outcome. There will be planning problems on the transmission side and market imperfections on the generation side. The point is, however, that planning optimal transmission and pricing it in a way similar to competitive pricing is a reasonable course of action. In principle, it does what we want, and in practice it should work fairly well if the planning and pricing are reasonably accurate.

So in a system with renewable subsidies set correctly, we now have a reasonable, two-step prescription for how to minimize the total cost of providing power to satisfy the load customers:

1. The transmission provider should build the same transmission that would be planned by a planner with control over both transmission and generation (a vertically integrated utility).
2. The independent power producers should be charged competitive prices for transmission services.

Fortunately, the theory of competitive transmission pricing has been well developed in recent years and is known as “congestion pricing,” “nodal pricing,” or “locational marginal pricing.” Implementing such options is not without complexities.<sup>20</sup> However, the next chapter will elaborate on Step 2 and present an alternative way to approximate the long-term average of congestion prices for transmission built for remote

renewable generators. This approximation is far simpler than real-time congestion pricing and will capture the most important benefit of the pricing signal required by Step 2. While technical planning can take different forms and tools are varied, the next section will current examples that describe the main principle that should be achieved with Step 1.

### 5.3.2. A Transmission Planning Example

Renewable energy subsidies will likely have one of two goals—producing all renewable energy up to a certain price or producing a certain quantity of renewable energy. Quantity is the more common goal, although it is often disguised as price until the price is clearly seen to be achieving the unstated quantity goal. Then the price is adjusted administratively to bring actual renewable energy quantities closer to the unstated quantity objective. In any case, transmission planning needs to be able to address both types of goals. The following example assumes a quantity goal of  $Q$  MW of renewable energy produced on average, but the end of this section will show how a slight modification of the planning process can tailor it to a renewable-energy price target.

Step 1, above, requires building the right lines. This example shows how new lines should be analyzed. It would be convenient if there were a way to tell if one specific line should be built or not, just by examining that line, but there is not. There is, however, a way to make quite a good decision by focusing on just the renewable lines and generators.

The proper question is whether a certain combination of lines and renewable generation should go forward as a complete package. Planning must proceed in cycles. The previous chapter developed a formula (equation 2) that calculates the cost of power produced by the transmission line itself. This is the additional power available to the system because the generator is located at the far end of the line instead of on the existing grid. If this cost is less than the value of renewable energy, it would seem that the line is worth building. For example, if the line produces power for a cost of US\$90/MWh

<sup>19</sup> Of course, there may be several plans that are near minimum cost. This is not a problem because each will be close to an outcome that a slightly imperfect competitive market would produce, and all these outcomes will be quite efficient.

<sup>20</sup> This is a theory of how to price transmission services from existing transmission based on a competitive auction in which generators bid for those services. This theory does not describe how such prices could induce optimal transmission investment—only how to price it optimally once it exists. Derivative financial products, such as financial transmission rights, are based on these prices, but are used just to manage risk. Congestion pricing is simply an application of marginal-cost pricing to transmission services.

when the value of renewable energy is US\$135/MWh, the line should be built.

We now extend the analysis of the cost of renewable energy produced by a remote transmission line to a framework for comparing transmission plans. This will allow us to select the least-cost plan. The first step is to compute the net benefit generated by a remote line. Net benefit is, of course, value minus cost. We have already discussed the renewable energy value in the previous chapter, where we defined  $V$  to be the value of renewable energy. There we found that renewable energy prices under a FIT can be composed of two parts: a uniform value of renewable energy,  $V$ , and a renewable manufacturing subsidy. The definitions required by the new cost-saving equation are

- $Q_R$  = the average MW output of renewable power produced at the remote location.
- $Q_B$  = the average MW output that could be produced at the BBS for the same cost.
- $Q_T = Q_R - Q_B$  = the average level of renewable power “produced” by the transmission line (MW).
- $C_{QT}$  = the cost of “producing”  $Q_T$  (\$/MWh).
- $V$  = the uniform value (across technologies) of renewable energy (\$/MWh).<sup>21</sup>
- $NB_T$  = the average hourly net benefit from using a remote transmission line to support  $Q_R$  of renewable production (\$/h).
- $C_{DS}$  = the cost of any deep-system upgrade needed to support  $Q_R$  (\$/h).

With these definitions, the average savings from the line is given by

$$NB_T = (V - C_{QT}) Q_T - C_{DS} \text{ (measured in \$/h)} \quad (6)$$

Note that this is net benefit, that is, renewable energy value minus transmission cost. As discussed in the previous chapter,  $Q_B$  should be evaluated at the BBS—the least-cost site for generating the same type of renewable energy as  $Q_R$  while just breaking even. (Note that because generators do not pay the full cost of the required transmission upgrades, a break-even site can have higher transmission costs that are not reflected in lower generator profits, so two BBSs do not necessarily have the same total cost of generation and transmission.)

Having defined net benefit,  $NB_T$ , we can restate the transmission planner’s problem in more practical terms. The technique used is to think of power lines as producing renewable energy. If this energy costs less than its value,  $V$ , the difference is its net benefit. The planner’s objective is to find the set of transmission lines that maximizes total net benefit while producing the target renewable output,  $Q$ . It is necessary to include all the renewable transmission, even the deep-system upgrades that are deemed to be for renewable projects. It is not necessary, however, to include anything more about the cost of renewable generation, because this is included correctly in the savings from the transmission lines. (Note that a deep-system upgrade is considered as producing no renewable energy, and will therefore only contribute to cost.) The transmission planning rule can then be summarized as follows: Build the transmission set that maximizes the net benefit—the value of renewable energy produced by transmission minus the cost of new transmission, including the cost of deep-system upgrades. This is just a more practical version of Step 1 above.

The transmission planner’s problem is then to find the plan that maximizes the net benefit, which can be either positive, if the remote savings is large, or negative, if the deep system costs are high. Figure 5.2 illustrates this with a specific example.

**Figure 5.2: Comparing Three Transmission Plans**

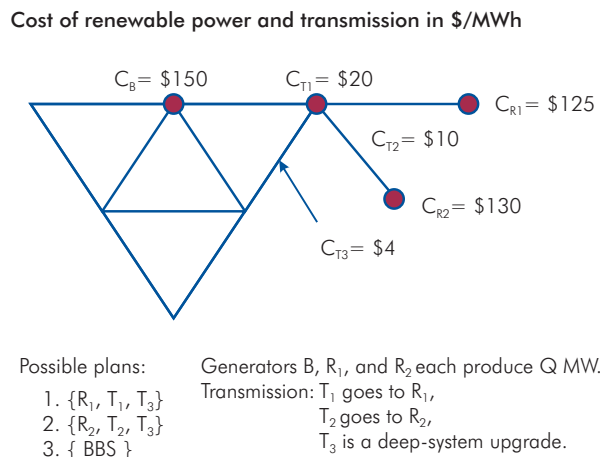

<sup>21</sup> As mentioned previously,  $V$  is much more uniform than the cost of renewable energy across different technologies, but it does vary because technologies differ as to when they produce their energy (time of day, and season). See Joskow (2010) for a comparison of the value of solar and wind energy. Also, the carbon content of a normal system power affects  $V$ .

In this example, the cost of capacity,  $C$ , can be taken to be US\$37.50/MWh, meaning that, if it produced at full output all the time, the cost of its power would be only US\$37.50/MWh. However, at the BBS, the capacity factor is assumed to be only 0.25, so the cost of power at BBS is  $C / f_{R_1}$  or US\$150/MWh. At location  $R_1$ , the capacity factor is 0.30, so the cost of production is reduced by the factor (0.25/0.30) to US\$125/MWh. At location  $R_2$ , the capacity factor is 0.2885, so the cost of production is US\$130/MWh.

Figure 5.1 shows three possible transmission plans that accommodate an annual average renewable output of  $Q$  MW. The first plan builds transmission line  $T_1$ , the longest line, which reaches the best renewable resource. The second builds line  $T_2$  instead, which results in generation costing slightly more, US\$130/MWh. However, line  $T_2$  is cheaper and costs only US\$10/MWh to transmit power back to the main system grid, instead of US\$20/MWh, the all-in, levelized cost of using line  $T_1$ . With either Plan 1 or Plan 2, it will be necessary to make a deep-system upgrade by improving line  $T_3$ . Although this upgrade will serve several functions, a cost of US\$4/MWh is attributed to handling the renewable energy produced at  $R_1$  or  $R_2$ . Finally, the third plan is to build generation at the BBS where, coincidentally, no new transmission—neither a remote line nor a deep-system upgrade—will be needed.

Table 5.1 shows the computation of net benefit from Plan 1. The first two steps compute the cost and value of the power produced by the remote line. The final step, 3, subtracts the cost from value to find the net benefit of the plan.

**Step 1a.** First, the power produced by line  $T_1$  is computed according to equation 1a. This is the extra power that results from placing the renewable generation at a high-quality remote location  $R_1$  instead of at the BBS. If  $Q$ , the renewable output generated by any of the plans, is 150 MW,  $Q_{T1} = 25$  MW because the same-cost renewable generator placed at BBS would generate only 125 MW. However, the example leaves  $Q$  unspecified, so  $Q_{T1}$  is just found to be  $Q / 6$ .

**Step 1b.** Next, equation 2 is used to find the cost of the power computed in Step 1a. This is proportional to the cost of the remote line  $T_1$ , and is smaller if,  $Q_{T1}$ , the power produced by the line is greater.

**Step 2.** Obtains the value of renewable energy from the policymaker in charge of renewable subsidies. (It is independent of the source, but technically it does vary with the time profile (diurnal and seasonal) of the renewable energy (Joskow 2010).) This value will be higher than the average price of nonrenewable wholesale power. In this example, the value used is US\$135/MWh.

**Step 3.** Calculates net benefit—value minus cost. First, the cost of the transmission-produced renewable energy, measured in US\$/MWh, is subtracted from its value, also in US\$/MWh. This is multiplied by the amount of transmission-produced energy (in MW) to find a net cost in US\$/h. Any deep-system upgrade cost measured in US\$/h is then subtracted to find the complete net benefit.

The second transmission plan can be evaluated in exactly the same manner with the following results:

**Table 5.1: Transmission to Remote Location 1 ( $Q_{R1} = Q$ )**

**1. Compute the average quantity and cost of power produced by transmission to  $R_1$**

Power produced by $T_1$	$Q_{T1}$	$Q - (C_{R1} / C_B)Q$ (1a)	$Q \times (1 - 125/150)$	$(Q/6)$ MW
Cost of $Q_{T1}$	$C_{QT1}$	$C_{T1} \times Q_R / Q_{T1}$ (2)	$20 \times 150 / (150 - 125)$	US\$120/MWh
<b>2. Find the value of renewable generation from the renewable policy maker</b>				
Value of $Q_{T1}$	$V$	$V$	135	US\$135/MWh
<b>3. Compute levelized hourly savings from remote lines</b>				
Net benefit from $Q_{T1}$	$NB_{T1}$	$(V - C_{QT1}) \cdot Q_{T1} - C_{T3}$ (6)	$(Q/6)(135 - 120) - 4$	<b>-US\$1.50 × Q/h</b>

Source: The authors.

Power is average power, and net benefit from  $Q_{T1}$  is average net benefit. Cost of the system upgrade is levelized cost.  $Q$  = the target or predicted number of MWh of renewable power produced under each plan. Equation numbers are shown in parentheses in column 3.

**Table 5.2: Plan 2: Transmission to Remote Location 2**

1. Compute the average quantity and cost of power produced by transmission to R <sub>2</sub>				
Power produced by T <sub>2</sub>	Q <sub>T2</sub>	$Q - (C_{R2}/C_L)Q$ (1a)	$Q \times (1 - 130/150)$	(Q/7.5) MW
Cost of Q <sub>T2</sub>	C <sub>QT2</sub>	$C_{T2} \times Q_R / Q_{T2}$ (2)	$10 \times 150 / (150 - 130)$	US\$75/MWh
2. Find the value of renewable generation from the renewable policy maker				
Value of Q <sub>T1</sub>	V	V	135	US\$135/MWh
3. Compute levelized hourly savings from remote lines				
Net benefit from Q <sub>T2</sub>	NB <sub>T2</sub>	$(V - C_{QT2}) \cdot Q_{T2} - C_{T3}$ (6)	$(Q/7.5)(135 - 75) - 4$	<b>US\$4.00 × Q/h</b>

Source: The authors.

Table 5.2 shows that Plan 2 is much better than Plan 1. It saves US\$4.00 for every megawatt-hour of renewable energy produced instead of costing US\$1.50 per megawatt-hour as does Plan 1. This is because transmission to the remote location costs only half as much as in Plan 1, and it provides generators with almost as good a renewable resource. This illustrates the inefficient outcomes that can occur if renewable generation providers decide where to locate if transmission costs to them are completely eliminated. Under such a system, the investor would pick location R<sub>1</sub> because their generators would be somewhat more productive and they would earn more excess profits.

The final plan is trivial to evaluate because it builds no transmission at all. So the net cost of Plan 3 is zero, which is worse than Plan 2, although better than Plan 1. If these three plans are the only ones that appear sensible to evaluate, the planning process is done, and Plan 2 is the result.

**5.3.2.1. Additional Example**

Note that even though the efficient transmission plan reduces costs, it will not, on its own, necessarily save consumers any money at all.<sup>22</sup> Transmission pricing is needed to achieve this objective. To illustrate this, we construct a new example based on the previous example. The only change is that the target production of renewable energy, Q, is assumed to be 200 MW, and we assume that each of the two remote sites has room for only 100 MW of low-cost production. The essence of this example is simply the assumption that, given

the quantity of renewable energy targeted, it will make sense to produce some at the BBS because the quality of the renewable resource there is reasonably high and no transmission is needed. This might correspond to, for example, a solar array in a sunny urban area. This example can be evaluated simply by combining results from the previous example. There are four possible plans, and they are evaluated in Table 5.3.

The cheapest plan, Plan 2, relies on the two cheapest options from the previous example and omits the remote line T<sub>1</sub>, which is most expensive. Because local renewable generation is needed, the subsidized price for renewable energy needs to be set at US\$150/MWh, which is the cost of renewable energy at the BBS (see Figure 5.1). Consequently, the generators locating at R<sub>2</sub> will be paid US\$150/MWh, even though they earn US\$20/MWh more than the BBS generators, which means US\$20/MWh more than they need to break even. The benefits of the expensive transmission to the remote location all accrue to the remote generators, who would be earning excess profits. In fact, the remote generators capture not just the full cost of the transmission—US\$10/MWh—but also another US\$10/MWh in additional locational rents.

Now it might seem that the solution to this situation is to lower the price paid for renewable energy to the remote generators at R<sub>2</sub>. In normal markets, however, some suppliers are usually cheaper than others, and they earn excess profit. There is generally no good way around this. In particular, it would be impractical and almost unrealistic for a regulator to attempt to evaluate

<sup>22</sup> If all renewable transmission is built on remote lines and charged the expansion cost of these lines (as discussed in the next section), building remote transmission can save consumers money.

**Table 5.3: Three-Plan Example,  $Q = 200$  MW**

<b><math>Q_{R1}</math> and <math>Q_{R2}</math> are limited to 100 MW each</b>							
<b>Planned renewable production</b>				<b>Cost</b>			<b>Net benefit</b>
<b>Plan</b>	<b>At BBS</b>	<b>At <math>R_1</math></b>	<b>At <math>R_2</math></b>	<b>At BBS</b>	<b>At <math>R_1</math></b>	<b>At <math>R_2</math></b>	
1	100	100	0	US\$0	US\$150/h	n.a.	– US\$150/h
2	100	0	100	US\$0	n.a.	– US\$400/h	+ US\$400/h
3	0	100	100	n.a.	US\$150/h	– US\$400/h	+ US\$250/h
4	200	0	0	US\$0	n.a.	n.a.	– US\$0/h

Source: The authors.

Note: For the cheapest plan, some power is produced at the BBS.

n.a. Not applicable.

each project and set each subsidy rate to make the project break even. Moreover, this would take away all incentive for investors to build efficient projects and would replace that incentive with a powerful one to increase cost, given the provider's advantages provided by the asymmetry of information.

When it comes to transmission costs, the example shows a way to recover some of the excess profits earned by generators. In particular, the generators can be made to pay for some of the cost of the remote lines they use. This can be done without distorting incentives. In fact, such a charge will provide a much-needed incentive to use transmission wisely. The next chapter describes how this can be achieved. It requires pricing the use of the transmission line approximately as a competitive market would price it. When reading this next section, it is important to keep in mind that most remote generators will still receive part of the line cost and some additional locational rent as excess profits. They will be winners in the remote location game, even if consumers manage to recover part of the cost of the lines that allow remote generators to earn their locational rents.

### 5.3.3. Note on Planning for Uncertainty

The example above presents a nearly deterministic approach. It does, however, assume that the cost of transmission used in the calculations is an expected cost, and in this way accounts for some uncertainty. It would also use an expected investment in renewable generation. However, it makes no attempt to account for uncertainty in future developments that occur after the planning horizon. A methodology for planning to

accommodate renewable investors while accounting for subsequent uncertainty can be found in Van der Weijde and Hobbs (2011). Other practical approaches to account for other uncertainties have been discussed in Chapter 3.

Although the example is stylized, especially concerning uncertainty, its objective is to demonstrate for transmission planners how to take account of renewable costs and benefits that are defined somewhat ambiguously by policy makers. This provides a key foundation for planning for renewables. There is less value in using sophisticated planning techniques when the basic policy inputs have not been well defined. Because not all policies may mesh well with planning criteria and techniques, this initial step is particularly important.

### 5.3.4. Achieving Quantity Goals and Price Targets

The above example assumed a policy objective of  $Q$  MW of renewable power production. To achieve such a goal, the transmission planner needs to consider all plausible transmission plans that would support this level of production and then find the one that maximizes net benefits. Such a process was illustrated with example 1.

However, it simplifies by assuming that the list of transmission plans producing a particular  $Q$  could be easily obtained. More likely, whether the target is quantity or price, it will be necessary to formulate a list of transmission plans that appear plausible and then evaluate them. Only after evaluation will it become

clear how much power they are likely produce and at what cost. Valuing alternative plants has proved to be beneficial both in the case of Texas and Midwest ISO presented in Chapter 3. The results of the first evaluations may help guide the formulation of other plausible plans to evaluate. This process cannot be completely systematized, but the important aspect is that the process of finding the net benefit will allow the efficiency of the plans to be judged with some accuracy. Then, after a number of plans have been evaluated, an efficient plan that achieves either roughly the right quantity or the right price can be selected.

#### **5.4. A Note on Variable Output, Congestion, Reliability, and Cost**

For variable power generation, such as wind and solar power, special consideration could be exploited when it comes to determining investment needs, given congestion and reliability considerations. The variable output of power generation technologies may allow for special treatment; this includes allowing for spilling wind or solar power when the extra cost of transmission is not worth the additional generation.

A congested line is not an unreliable line. It is simply a line that is being fully utilized. When this happens, the system operator does need to pay attention, so that the line's flow limit is not exceeded. However, this limit is set well below the point at which the line would be damaged, so even if the limit is somewhat exceeded, all that happens is that the system becomes somewhat more vulnerable to other "contingencies"—unexpected problems.

The point is that there is no reason not to have the line fully utilized—congested. System operators can handle such situations without difficulty. Most of the time, though, when a line is fully utilized, it is because there was a desire to use even more capacity, but that

desire was curbed. For example, generation and load might want to use 120 MW of capacity when the line's reliability limit is only 100 MW. In this case, 20 MW of potential use will be disallowed and only 100 MW will be transmitted. The problem here is not reliability. Rather, the problem is that, if transmitted, the extra 20 MW would have had some value, and that value would be lost.

If such a situation (20 MW of denied service) occurs for one hour per year, and the value lost is US\$100/MWh not transmitted, the annual loss of value is US\$2,000. If the levelized cost of expanding that line to 120 MW of capacity is US\$200,000 per year, it would not be worthwhile to eliminate the one hour per year of congestion. Therefore, transmission for renewable energy does not necessarily need to be built to transport all wind power output, specially peaks during short periods. This will depend on the value of such extra power and the cost of extra transmission. Examples of this consideration are emerging in planning studies for renewable energy. One example is the Western System Coordination Council of the United states (Enernex 2011), which takes into account the strategic cost-saving possibilities of spilling wind and not always expanding transmission to absorb 100 percent of expected wind production.

New reliability formulation that take into account the variability of new generation resources are emergin in technical research. These new reliability measures take into account more accuratedly the statistical properties of renewable output and they way such properties interact with system reliability. By doing so, as described by Moreno, Pudjianto, and Strbac (2010), larger renewable power transfers could be achieved at lower cost, since transmission can be saved if compensated with more generation reserves. Although these cost-saving opportunities are highly dependent on each sytem, and their practical implementation requires careful study, they are worth mentioning.





## 6. ECONOMIC PRINCIPLES OF TRANSMISSION PRICING

Transmission must be paid for; there are two approaches—pricing and cost allocation. Pricing is used to improve the efficiency of generation dispatch and investment, but it usually collects too little to cover costs, so the remaining costs must be allocated. The first pricing rule requires that any transmission facility used by only one generation investor should be paid for by that investor. The second pricing rule requires shared transmission to be priced so that expansion costs will be fully covered when the line is fully utilized. An important fringe benefit of transmission pricing is that it can recapture part of the excess profits (locational rents) that could be provided by transmission and return them to the consumers who must pay for any uncovered transmission costs.

Renewable transmission pricing will likely fall well short of covering the cost of lines to remote locations, and it will not cover the cost of deep-system upgrades for renewables, so the uncovered costs will need to be allocated. Since the benefits of renewable energy are global or national, cost allocation should be as broad as practical.

### 6.1. Observations on Traditional Principles of Transmission Cost Allocation and Pricing

Transmission costs are allocated by a different method in every jurisdiction. There is no standardization, and there is no clear agreement on the best approach to follow, neither from the economic theory nor the practical experience. All methods used in practice to allocate cost tend to be supported by ad hoc “principles” that, although they may seem reasonable, their economic foundations are hard to justify. These principles include cost causality, efficiency, and transparency. Most systems use more than one cost-allocation method or combinations of several methods, as explained in Chapter 2. Fortunately, the various methods can be grouped into a few categories when it comes to network costs, namely postage stamp-based methods and usage- or flow-based methods. When it comes to connection costs, Chapter 2 also explained how the boundary between network and connection costs is not always clear, but for the most part, connection assets always include those that are used exclusively by the interconnecting generator.

### 6.1.1. Charging Generation vs. Charging Load

The most basic point about transmission tariffs is that systemwide, it essentially makes no difference whether charges are applied to generators or consumers. Either way, consumers will bear the cost of transmission in the long term. When generators are charged per megawatt-hour, they see this as an increase in their marginal cost of production, and marginal costs are passed on as price increases when all producers experience the same cost increase. This is true under perfect competition. If all generators have some monopoly power, theory suggests that they will pass on a marked-up marginal cost. In this case, charging generators will result in an increase in generation profits and in consumers paying more than 100 percent of the transmission costs.

However, if some generators are singled out and charged more, the variable cost increase is not uniform. Such a charge can be useful if some generators receive special treatment in the form of extra transmission built specifically to benefit a small minority of generators. In this case, those generators can be charged extra, and they will not be able to pass on the costs to load. This will prove useful to define transmission pricing for renewable generation so that the basic trade-off discussed in previous chapters is enforced through pricing signals.

### 6.1.2. Charging on a per-Megawatt or per-Megawatt-Hour Basis

Transmission cost can be allocated to load in two fundamentally different ways—as an energy charge or as a demand charge. A demand charge is usually based on the customer’s power use at the time of the system’s peak power use. This is called a coincident-peak demand charge. Such a charge makes more sense than a charge based on the customer’s individual peak usage because a “good” customer will use the most power at night when the cost of power is low, and such usage should not be discouraged. What should be discouraged is using power when it is in short supply. That tends to be when system demand is highest. In a system with efficient real-time pricing, there is no need for demand charges. In most systems, however, demand charges will decrease the peak capacity needed to maintain reliability, which will reduce costs. The same amount of energy will be produced with less capacity.

For customers subject to fairly accurate, real-time pricing, demand charges are not appropriate, and energy charges (per megawatt-hour) should be used instead. Also, customers without real-time meters cannot be charged for coincident peak demand because it is not measurable. These customers will also need to be charged per megawatt-hour. In fact, a uniform per-megawatt-hour charge is a good approach to transmission pricing because it causes no distortions in the price of power and hence no inefficiencies. When renewable generation faces its share of a uniform network charge, the same can be said about charging on a per-megawatt-hour basis. Practical implementations of charges to renewable generation are largely moving in this direction, as presented in Chapters 2 and 3.

### 6.1.3. Flow-Based Methods vs. Postage Stamp Methods in the Context of Renewable Energy

As described in Chapter 2, flow-based approaches to charging network assets are sometimes perceived as unfair for renewable energy when generators are allocated part of the network costs. Estimating how a particular power injection or transaction from point A to point B “uses” the infrastructure is typically based on an engineering approach, but such a cost allocation is usually not well grounded in economics. There are tens of alternatives for determining how a transaction affects the “use” or “flows” in the system. Each alternative could lead to different results. In addition, each method could also lead to different results, depending on the assumptions, convergence settings, and parameters used in the load-flow models that these alternatives require. For these reasons, such methods tend to lack credibility regarding their ability to determine cost-causality. The main benefit of such systems is simply that they can ensure cost recovery, which is, necessarily, the main goal in any cost-allocation method.

This does not mean that cost allocation should not be efficient. When it comes to renewable energy, megawatt-hour charges are an efficient method of recovering costs that cannot be allocated on the basis of cost causality. Charges that unequivocally reflect causality are really prices because they are designed for the purpose of providing cost-minimizing incentives. Such prices policies will be discussed next.

As mentioned in the previous chapter, peak generation does not necessarily drive transmission investments for connecting renewables. Simpler megawatt-hour postage stamp methods are being embraced in recent efforts to allocate transmission costs triggered by renewable generation, as in the case of MVP in Midwest ISO or Texas.

There is an additional argument to support this trend. Benefits of using renewable energy do not come from its generation, but rather from the fossil fuel it displaces. In the case of climate change, the benefits are global, and in the case of energy-source diversity, the benefits are national, but widely distributed. It must be noted that this does not exclude the need to charge renewable generation for some transmission cost to ensure efficient outcomes, both in terms of the cost and generation and transmission, as will be explained later.

## 6.2. Transmission Tariffs Mimicking Competitive Pricing

There are two reasons to charge for the use of transmission—economic incentives and cost recovery. Although some of the policies overlap, and both are often considered at once, the two viewpoints are different. Economics is about efficiency while cost recovery is just about who must pay the cost. Economics uses “prices,” while cost recovery uses “cost allocation.”

For an example of the difference, consider a new bridge that has been built larger than needed because the town expects to grow.<sup>23</sup> (A bridge, like a transmission line, can suffer from congestion and can need congestion pricing.) Presently there is more than enough room for everyone in the town to cross the bridge twice a day, which is what everyone wants to do—although some people would pay more to cross than would others. Some would pay no more than 50 cents to cross twice and some would pay US\$10. Suppose the loan to build the bridge is costing the town US\$1,000 per day, and there are 1,000 people in the town. Who should pay, and how much should they pay?

The standard cost-recovery answer is to charge users of the bridge about US\$2 per day, if at that price only 500 people per day would be willing to pay to cross at that price. This will just collect the needed US\$1,000 per day. The standard economic answer is to let everyone

<sup>23</sup> While people can choose which bridge they cross and power cannot choose its path, this example has only one bridge, and this difference causes no problem.

cross for free, because that is efficient—it does not waste spare bridge capacity. There is no reason to stop those who would pay less than US\$2 per day since they won't get in anyone's way. The first approach is a *cost allocation* of US\$2 per day per bridge user. The second approach is a *congestion price* of US\$0 per day.

So how would the economist repay the loan? Economics recommends the use of a nonstandard cost allocation. Charge everyone in the town US\$1 per day, whether they use the bridge or not. And of course, they will use the bridge, since it costs them nothing to do so. Now this may seem a bit unfair to the person that would only pay US\$0.50 to cross and now must pay US\$1.00. That's a loss of US\$0.50, but if there is a high price for crossing (US\$2), that person will also lose US\$0.50 in value because of not getting to cross the bridge. So no one is worse off with this policy and everyone but those with the very lowest bridge-crossing value are better off, and even those people break even. Also, if the town has other public projects, the efficiency gains may be spread around more evenly.

So economics suggests that the first step should be to set a price that causes goods and services to be used efficiently, and then, if that does not collect the required revenue, collect the rest while doing as little harm to efficiency as possible. This section takes the first step, and describes the efficient, economic price. The next section takes the second step and allocates the costs that are not covered by the price.

### 6.2.1. Fairness to Electricity Consumers

As seen in the example in the previous chapter, transmission can reduce production costs by more than the cost of the line. In a market, however, producers with lower production costs are rewarded with the entire cost reduction. This happens even in a market with a subsidized selling price (such as a FIT). The reward for lower cost is a powerful incentive for producers to cut costs and produce as efficiently as possible, and we should not interfere with this most-important incentive.

It does not seem fair, however, to ask electricity consumers to pay for all of the transmission line and then transfer an amount equal to the the entire cost of the line to the renewable generators in the form of excess profits (locational rents). This seems especially unfair, since most lines will provide more savings than the cost of the line, and that extra savings will accrue to

renewable generation investors, even if they pay the full cost of the remote power line. Making investors pay the full cost of the line will not be suggested.

Pricing the use of the transmission line appropriately will partly pay its cost, thereby refunding some of the excess profits to consumers. Such pricing will also increase the efficiency of renewable generation investment by inducing efficient solutions as explained in the previous section. (This means lower combined generation and transmission costs.) Because this approach does not require regulators to attempt to assess and claw back excess profits for each individual project (which for new renewable energy could be hundreds or thousands of projects), it will not distort or reduce the all-important incentive for producers to minimize their production costs.

### 6.2.2. Increasing the Efficiency of Renewable Generation Investment

In advanced power markets, congestion pricing is said to send “locational signals” to generation. In fact, this does not work well for reasons that will be explained below. However, a simple approximation to congestion pricing can actually do better. What is the point of these “locational signals” for renewable generation? Put simply, the point is to avoid encouraging investors to build poor-quality generation where it will waste much of the cost of building the transmission.

To understand how pricing reduces the misuse of valuable transmission, refer to Example 2 in the previous chapter. In that example, the subsidized price of renewable energy was US\$150/MWh. The remote line that was part of the best plan was justified by the fact that it made possible cheap, US\$130/MWh, renewable generation—US\$20/MWh cheaper than generation at the BBS. That savings in generation cost did not come free. It required a line that cost US\$10/MWh of energy transmitted. That makes sense, but it makes sense only if high-efficiency generation gets built at this remote location. If a US\$145/MWh generator gets built, it will be quite profitable for the investor—who will make US\$5/MWh of excess profit, but it will be a waste of transmission resources. It is worth taking a closer look at this argument.

Figure 6.1 shows the same US\$10/MWh remote transmission line as in Example 2. The subsidized price of renewable energy is US\$150/MWh. Now suppose that the US\$10/MWh line can handle three of the

six renewable energy projects shown at the remote end of the line. If the best three are selected, they will average US\$130 just as the transmission provided had anticipated. The energy “produced” by the transmission line was based on this low cost of energy and that was based on the availability of an excellent renewable resource and renewable energy projects that made good use of this resource. Besides the high-quality projects, low-quality projects are always available as well. They may be low quality because a wind turbine is sited downhill instead of on the ridge, or a solar project is poorly constructed, or some other project is located too far from the end of the US\$10/MWh remote line and so requires an expensive connection.

Since the line only has room for three of these projects, it is important to pick the three high-quality projects. However, if the transmission line is priced at US\$0/MWh—if this valuable resource is provided for free—all six of these projects, each with a different developer, will want to connect to the remote line. Since the subsidized price is US\$150, the three poor projects will make US\$1/MWh, US\$5/MWh, and US\$9/MWh, respectively, in excess profits. If the transmission provider asks “which projects are cheaper than US\$140/MWh,” all six projects will claim that they are. Consequently, the transmission provider will need to inspect them and try to determine their costs. This is difficult; the transmission provider is not equipped to perform this task and should not be. So it will probably just decide on a first-come, first-served basis. This, however, does not guarantee that the best project will use the scarce capacity. It could happen that the US\$149, US\$141, and US\$130 projects will request connection first.

**Figure 6.1: Why Charge for Some Transmission?**

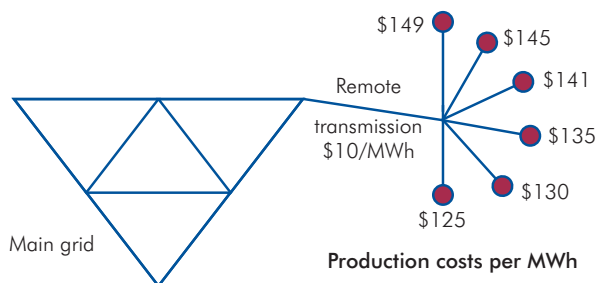

Source: The authors.

In this case, including the cost of transmission, the projects will actually be generating power at a cost of US\$159, US\$151, and US\$140/MWh. This is an inefficient outcome because this example assumes that the BBS can generate power for US\$150/MWh without the need to build any transmission. The only reason this transmission was built was to gain low-cost power at costs averaging US\$140/MWh, including transmission. So the cost of the line has not provided any benefit. Two-thirds of the projects it made possible are more costly than projects requiring no transmission at all. More importantly, this outcome leaves out two cheaper projects. Additional transmission investment will be required to integrate these projects that were left out.

### 6.2.2.1. Transmission Charges or an Auction

The problem just described is the natural consequence of fully subsidizing the cost the transmission cost. There are two options for solving this problem with both charging for the remote transmission. One approach is to set a charge for the use of the line that is based on the cost of replacing what is used up. The other approach is to auction off the use of the line (see example in Table 6.1). Conceptually, the auction is simpler, but in practice the charge is likely to be the easier approach. In the above example, a second-price auction would work as follows.

In a second-price auction, the winners all pay the price of the highest losing bid. This motivates every bidder to bid competitively. If any bidder enters a low bid and

**Table 6.1: Auctioning Access to the Line in Figure 6.1, with a FIT Price of US\$150**

Project's cost of energy per MWh (US\$)	Bid per MWh (US\$)	Bid accepted	Price paid per MWh (US\$)
149	1	No	n.a.
145	5	No	n.a.
141	9	No	n.a.
135	15	Yes	9
130	20	Yes	9
125	25	Yes	9

Source: The authors.  
n.a. Not applicable.

wins, lowering the bid will not lower the price paid at all, but reducing a bid can cause a bidder to lose when the bidder would have wanted to win. So low-balling the auction can only make a bidder worse off. Because all bidders bid competitively, the bids are higher than in a first-price auction, and generally the auctioneer collects at least as much revenue. In any case, the resulting price, \$9/MWh, is almost enough to cover the cost of the transmission line. There are other detailed design issues that need to be taken into account, but an auction is one way to avoid the previous inefficient outcome.

The second approach is to charge generators the cost of the line capacity that they use up. This would mean charging for a share of the upgrade cost. For example, suppose the next likely upgrade would be a 100 MW upgrade. It may be best to define the size of the upgrade not by capacity but by the amount of average usage of the line when fully utilized—just before it is upgraded again. If this average usage is 100 MW, and the line costs US\$500/h (the levelized cost per hour), the charge for the line, even at the beginning when not fully utilized, would be US\$5/MWh. This logic leads to the following pricing rule.

**6.2.2.2. Transmission Pricing Rule**

Let  $X$  be the levelized, hourly cost (US\$/h) of the next expected expansion. Let  $Q$  be the size of the expansion in megawatts of useable capacity. Charge US\$( $X/Q$ )/MWh for use of the line.

If the line is expanded just after time  $T_1$ , and then must be expanded again just after  $T_2$ , the usable capacity of the expansion is the average power flow at time  $T_2$  minus the average power flow at  $T_1$ .

Compared with real congestion pricing, this is vastly simpler. There is just one price (perhaps escalated by inflation) during the whole period between expansions, instead of a new price every 10 minutes. Of course, such a long-term price cannot help with the dispatch or solve short-term congestion problems, but the main problem being faced is how to encourage the efficient development of renewable generation. In addition, short-term congestion pricing does not solve the problem, since renewable generators tend to have near-zero marginal costs. Short-term congestion signals

might be more helpful to induce efficient dispatch of fossil generation. In the United Kingdom, revisions of the transmission charging method have opted to keep a locational component in network charges applied to renewable generators. The location signal, similar to the proposed approach, is based on long-term incremental (expansion) costs.

**6.2.3. Why Expansion-Pricing is Approximately Long-Term Congestion Pricing**

We have just seen that charging the expansion price for the use of remote transmission is fair to consumers (who would otherwise pay for even more excess profit) and improves the efficiency of remote generation investments, but how does this fit with most common transmission pricing theory?

Transmission pricing theory is mainly an application of standard, competitive, marginal-cost theory to the production and distribution of electricity. It would be risky to diverge significantly from such a well-established analysis. Fortunately, the suggested pricing approach is just a convenient approximation to standard congestion pricing (marginal cost pricing). And, since congestion pricing is too complex for most current power systems, this simplification captures the most important part of the congestion-pricing signal for renewable generation—the long-term, locational signal.<sup>24</sup>

What tells us that the expansion price is an approximation for the long-term average of congestion prices, which are known to be extremely volatile? The connect between the two comes from a fundamental result of congestion pricing theory.

*Congestion-pricing result.* Consider an optimally sized transmission line with a sunk cost of US\$ $F$ /h and a “variable” cost of US\$ $V$ /h. For each megawatt of capacity, congestion pricing will pay for the variable part of the line’s construction cost.

To understand the connection between variable construction cost and expansion cost, consider the following example. If the construction cost of a line is approximated as  $C = F + V \times Q$ , where  $Q$  is the line’s capacity,  $V$  is the variable part of the construction cost. The levelized cost of the line is  $C$ , so if the  $F =$

<sup>24</sup> When generators using the line have similar marginal costs, the dispatch function of congestion pricing becomes much less important.

US\$100/h, and  $V = \text{US}\$9/\text{h}$ , and  $Q = 100 \text{ MW}$ , then  $C = 100 + 900 = \text{US}\$1,000/\text{h}$ . On average, this comes to  $\text{US}\$10/\text{MWh}$ , which is the cost of the optimal line in Figure 6.1 and Examples 1 and 2.

The congestion-pricing result tells us that, in the long term, congestion prices will pay an average  $\text{US}\$900/\text{h}$ , or  $\text{US}\$9/\text{MWh}$ . So, given the present formula for  $C$ , if the line is optimally sized, congestion pricing would charge generators an average  $\text{US}\$9/\text{MWh}$ . This is the long-term average congestion-cost, and our proposal is to charge the expansion cost. Suppose the next expansion would be a 100 MW expansion. According to the cost formula, cost would rise from  $F + V \times 100$ , to  $F + V \times 200$ . In other words, cost would rise by  $V \times$  (the expansion in megawatts), or in this case  $\text{US}\$9/\text{MWh} \times 100 \text{ MW} = \text{US}\$900/\text{h}$ . On a per-megawatt-hour basis, however, the expansion cost is  $\text{US}\$9/\text{MWh}$ , which is the variable part of the line's construction cost. So for an optimally sized line that has a linear cost formula, the long-term average congestion cost is the same as the expansion cost, and our simple pricing rule exactly matches long-term average congestion pricing.

#### 6.2.4. Why Expansion-Pricing is Better than Congestion Pricing

Transmission lines cannot always be optimally sized, because of the lumpiness of the size options. So the congestion-pricing result does not always hold. If a line is too large for the initial load that it needs to manage, congestion will be infrequent, and the average congestion price will be low. So it will not pay for the variable part of construction costs. This is a frequent outcome of actual congestion pricing implementation (see Chapter 2). Sometimes lines are larger than what the congestion-pricing result considers optimal because that definition of optimal may not properly account for reliability rules.<sup>25</sup> So the congestion pricing signal will again be too low to send a strong locational signal, and too risky for an investment to be developed based on the revenues generated from such a stream of income.

The expansion-pricing rule recommended here will not be affected by the capacity of the line because it is

based on expansion costs, so it will certainly send strong locational signals and will recover a significant part of the line's cost for consumers, even if it is overbuilt from a congestion pricing point of view. Basically, as long as the line saves generators more in production costs than the line costs, the recommended pricing should work well. While planning is always subject to mistakes, pricing should be the way to confirm that the lines are useful and to avoid overbuilding or inefficient generation and transmission outcomes.

The second advantage of expansion pricing is that it is a low risk for investors. The cost of transmission services will be known with certainty from the time the investors go on line until the time of the next expansion, and it will be reasonably predictable even after that. In contrast, congestion pricing starts out being extremely inexpensive or free, and then increases later as the line becomes more congested. If congestion pricing works perfectly, the increase in transmission costs in the later years is so great that it makes up for all the low-cost early years. However, this increase in congestion, and hence in the congestion price, will be driven by future investments that increase the use of the line. And such investments are very hard to predict. So an early investor does not know how soon congestion cost will increase or how long they will stay high before the line is expanded and the congestion costs again fall back toward zero.

#### 6.2.5. Charging Full Price for Private Lines

Expansion-cost pricing does not charge for the one-time cost of building lines. In the simple cost formula,  $F + V \times Q$ , it does not charge for  $F$ . However, there is an exception to this rule. Generation investors should be free to site their generator wherever they want, but they should generally pay for the line to reach the grid.<sup>26</sup> Transmission is not qualitatively different from other capital investments, such as generators, wind turbines, or the towers they are mounted on. So the only reason generation should be treated differently is that it is usually shared by several investors. When it is not shared, however—when it is private—it should be treated as any other private investment, and the investors should pay the full cost.

<sup>25</sup> For example, a line might be expanded for reliability reasons when it becomes congested 2 percent of the time, even though congestion charges were still far too low to pay for the expansion.

<sup>26</sup> Of course, this does not mean that the grid should not be extended to good renewable resources. It only means that if an investors wants to locate some distance from the grid, this is perfectly acceptable.

In the case of renewable generation, where subsidies to generation are introduced for a policy reason, why not subsidize their transmission as well? The reason is simply that this method of subsidization would be inefficient compared with paying more for renewable energy. It is a matter of subsidizing inputs versus subsidizing the output. The purpose of having private investors build renewable generation is to take advantage of their detailed knowledge of input costs and their powerful incentive to minimize these costs, to balance the basic trade-off. However, they will minimize input costs (and hence produce efficiently) only if they must pay the true cost of inputs. If any input cost is subsidized, their powerful cost-minimizing incentive will operate on the distorted (reduced) cost they face, and they will minimize these distorted costs instead of minimizing the true costs.

An example will help illustrate the cost analogy between private lines and other private capital investments. Suppose that a wind turbine investor can increase the wind speed that its turbine is exposed to by moving it farther from the provided transmission. With a private line costing US\$1/MWh, it can gain 1 percent in wind speed, and with US\$2/MWh, it can gain 2 percent, and so on. Suppose that by increasing the height of its turbine’s tower, it can also gain wind speed, and the cost per increase in wind speed will be exactly the same. Why should we subsidize moving the wind turbine horizontally to gain stronger wind, but not subsidize moving it vertically to gain stronger wind? The costs and effects are identical. Clearly there is no reason to subsidize one and not the other, yet no one would suggest subsidizing the towers. This view is correct and it holds for wires, as well as towers.

**6.3. Broadly Allocating Uncovered Transmission Costs**

As explained above, transmission pricing is not intended to cover the cost of transmission, but rather to induce the development of efficient generation (for example, generation whose combined cost, including transmission, deviates from the less from the efficient benchmark). The expansion costs of shared remote lines to generation can be efficiently priced, as described in Chapter 3. Also, any expansion costs of deep-system upgrades that can be clearly attributed to a specific group of renewable generators should receive the same treatment. The same economic analysis applies to these as to the remote transmission analyzed in

the last section. Very little of the deep-system cost, however, is likely to be attributable in this way because physical power flows from generators generally cannot be tracked once they leave a radial line and enter the “deep system,” the meshed part of the grid.

As noted, if the expansion cost of transmission can be reliably assigned to specific groups of renewable generators (or to any other generators), those generators should be charged for these costs. When this is not possible, though, costs must be recovered by charging in some other way.

The benefits of renewable energy are the lack of emissions and the lack of fossil-fuel imports. These benefits are generally national or global, so it would not be rational to charge only users of renewable energy or only renewable generators. More importantly, what we want to avoid is inefficient solutions to the trade-off.

The transmission cost allocation mechanisms that track power flows are not relevant when the problem is to track power that has not been generated by fossil fuel. Similarly, license plate charges for deep-system reinforcement that vary from one region to another in order to capture the differentials in the cost of transmission make no sense. The benefits from renewable energy flow from the fuel that is *not* burned.

So the cost of transmission that is not covered by economically efficient transmission prices should be distributed as widely as possible. This is analogous to charging everyone in the town for the bridge—it is a way of charging that does little harm. This can be done by charging all generation in a per-megawatt-hour charge. Such a charge will be passed through to load, since it increases the variable production cost of every megawatt-hour uniformly. So if a per-megawatt-hour charge is to be used, it can be charged to generation or to load customers, and the choice should be a matter of convenience or ease of implementation. As shown in Chapter 2, more pricing systems are moving toward charging most of the uncovered network costs to consumers.

By contrast, it may be better to charge large customers a demand charge. This is a charge based on the customer’s demand during the system’s period of peak use. This would not be necessary or desirable if an accurate system of real-time pricing is already in place. If such system is not in place, a demand charge

can serve to significantly reduce the need for on-peak generation. This will save costs and improve reliability in a system that frequently sheds load during times of peak load. A combination of demand charge and energy charge might spread the burden most evenly while making use of demand charges. The exact mix that is best is difficult to determine because this is a second-best solution compared with real-time pricing. Renewable transmission charges will not be large, since they are spread so widely. If transmission is proactively developed—if the planner has made all the effort to reduce costs—the regulator will likely support allocating uncovered costs broadly. If a proactive planning process is not in place and costs are broadly allocated to consumers, there will be no incentive for the efficient development of transmission.

#### **6.4. Summary of a Framework for Proactive Provision of Renewable Transmission**

Although many complexities have been mentioned and taken into account, the suggested framework for the proactive provision of renewable transmission is simple. The framework relies on the principles collected in Box 6.1.

While implementation could take different forms, the use of principles can be summarized in the following steps:

- Choose a list of transmission plans that are candidates for maximizing net savings.
- For each plan, evaluate the following:
  - The energy produced by the planned transmission (equation 1).
  - The cost of that energy (equation 2).
  - The value of that energy (using the policy maker's renewable energy value,  $V$ ).
  - The cost of deep-system upgrades.
  - Net benefit = sum of values minus all costs.

- Choose the plan with the greatest net benefit.
- Charge investors for the full cost of any transmission that they alone use.
- For shared radial lines to remote renewable generators, charge each generator the average expansion (upgrade) cost per-megawatt-hour times its megawatt usage of the line.
- Collect the remaining transmission costs (likely over half the cost) by using some combination of energy and demand charges that spread the burden as broadly as possible.

The crucial aspects of this framework are as follows. First, it takes account of the benefit of locating renewable generation where there are high-quality renewable resources. Second, it takes into account transmission costs. Third, by charging for future expansion costs, it prevents the misuse of transmission while capturing excess profits from inefficient generators. The objective of this pricing principle is more directed toward making renewable generation more efficient by allocating some long-term transmission costs to them. Once this has been achieved, regulations should allow for recovering the required revenue from consumers.

A final, broad advantage is that this framework makes transparent the costs and benefits of renewable generation. While every cost-benefit analysis suffers from data problems, if its assumptions are not revealed, less can be said about the efficiency of the solutions. The suggested framework is very general, but could be implemented in different ways. Since contexts vary greatly, the report does not aim to provide a general solution, but rather a framework that is useful for analyzing policy alternatives.

#### **Box 6.1: Summary Principles on Transmission Expansion and Pricing for Renewable Energy**

**Principle 1.** Extra transmission is often worth the cost.

**Principle 2.** Allow the transmission provider to plan transmission proactively.

**Principle 3.** Maximize the net benefit of renewable transmission.

**Principle 4.** Transmission tariffs for generation should use efficient pricing.

**Principle 5.** Broadly allocate uncovered transmission costs.



## APPENDIX A: INVESTMENT ASSESSMENT BY JURISDICTION

### United States

The United States has been emphasizing the nation’s need for greater renewable energy and also actively trying to diversify its energy portfolio. The U.S. Energy Information Administration (EIA) estimates that U.S. electricity demand will grow by 39 percent from 2005 to 2030, reaching 5.8 billion MWh by 2030. To meet 20 percent of that demand, U.S. wind power capacity would have to amount to more than 300 GW from the current levels of 10 MW. This growth represents an increase of more than 290 GW by 2030 (U.S. DOE 2010b). In addition, NERC, through its annual 10-year reliability outlook (NERC 2009), established that the two primary drivers of transmission requirements are needs triggered by reliability requirements and by the needs of renewable generation (Figure A.1). Requirements are especially located in areas such as the Midwestern United States, California, and Texas, all pursuing important renewable energy programs.

It is convenient to look at the investment requirements in specific regions of the United States where there are important and innovative developments in developing renewable energy: the Midwest states region. The first is important for its regional and multi-jurisdictional nature, and the Texas region is relevant because of the results

**Figure A.1: Connecting Wind Farm to Existing Transmission Network**

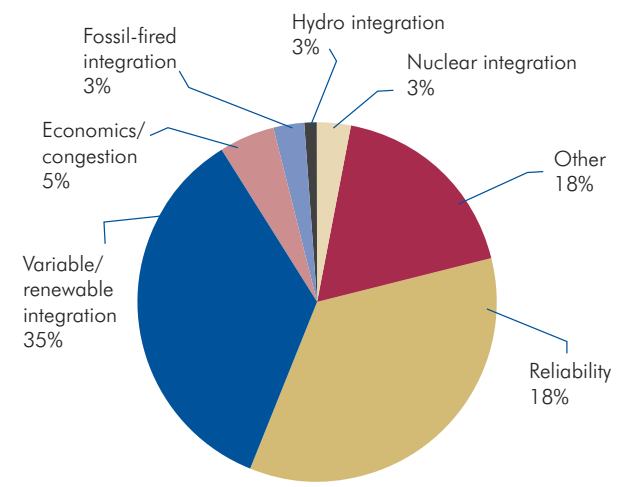

Source: NERC 2009.

already achieved in terms of developing transmission for renewable energy. The Regional Generation Outlet Study (RGOS) by Midwest ISO (2010) and the CREZ Transmission Optimization Study (ERCOT 2008a) estimate the size of the investment needs and describes the available options to meet the growing demand in these areas.

### Midwest ISO

The transmission expansion and its investment needs for Midwest ISO region are driven by state RPS (Renewable Portfolio Standards). This Midwest ISO service territory covers parts of 13 U.S. states and the Canadian province of Manitoba (Figure A.2). RPS from states within the Midwest ISO region vary from 3.5 percent up to 30 percent for the period between 2015 and 2025, and the targets refer mainly to wind power. The result of the RGOS shows that the transmission investment needs to meet the demand driven by the RPS and GIQ range between US\$12.7 billion and US\$15.1 billion. Such estimates depend on which overlay solution is selected among the three different strategies—the so-called Native Voltage, 765 kV, and Native Voltage DC—under the premise of a distributed set of wind zones with varying capacity factors and distances from the load. Figure A.2 depicts the selected set of renewable energy zones for the assumptions of the RGOS with transmission overlay of Native Voltage option.

The Native Voltage strategy focuses on a transmission development without introducing a new voltage class within areas. This solution has the advantage of the lowest net total cost of US\$49/MWh, and the estimated total cost for construction is US\$13.9 billion. The 765 kV overlay strategy assumes the development of transmission with a new voltage class into much of the RGOS area with its estimated construction costs of US\$15.1 billion. This overlay’s Adjusted Production Cost (APC) savings are greater than the Native Voltage overlay and Native Voltage DC overlay. The Native Voltage with DC strategy involves the development of transmission facilities with a new voltage class with DC. This option offers the lowest construction costs of US\$12.7 billion, the lowest levelized annual costs of US\$1.3 billion, and the lowest annual costs of US\$15/MW among the three strategies proposed. This solution could be considered as an option for bulk energy delivery from renewable energy areas across long distances, since the costs of adding DC to the system are rather high compared to the AC alternatives

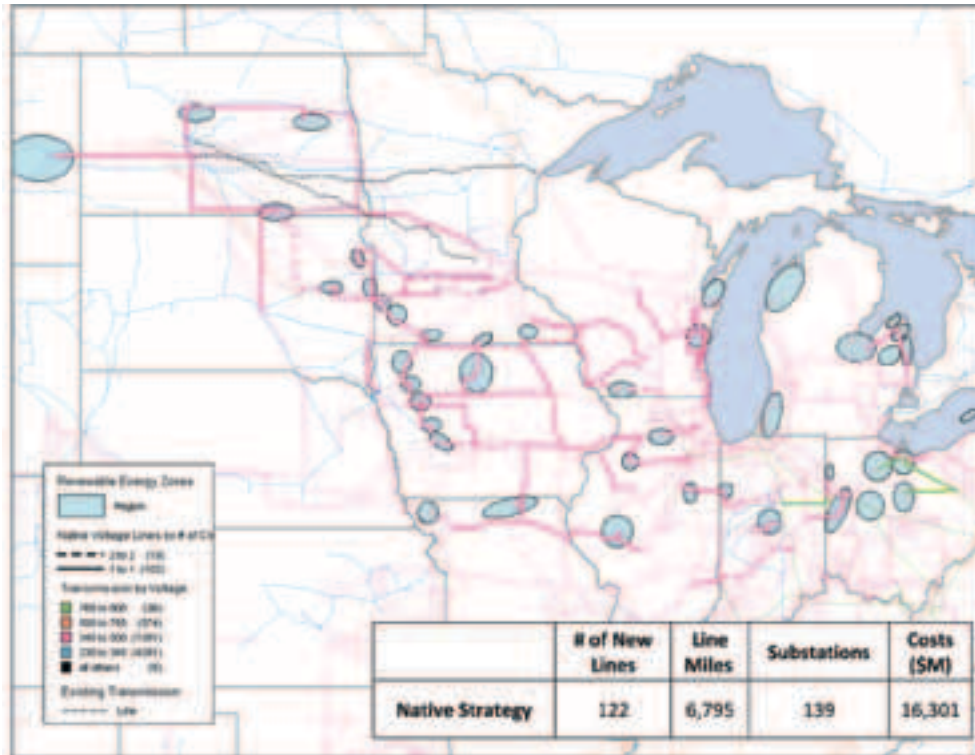
**Figure A.2: Native Voltage Transmission Overlay**

Source: Midwest ISO 2008; 2010.

at shorter-distance needs, and the entries to tap the lines are much more expensive and less integrated than providing AC paths across the system. Table A.1 summarizes the competitiveness and advantage of each strategy option, in terms of construction costs for transmission, levelized annual costs, annual costs, adjusted production cost, and net total costs.

It is notable that the Midwest ISO is expanding its transmission at a significant scale. For example, the investment needs from the recent planning studies done by Midwest ISO for the proposed transmission expansions are estimated at about US\$5 billion for 2011. This is a very high level of transmission investment, equivalent to about five times the average annual new transmission investment in the Midwest ISO area.

### **Texas—Competitive Renewable Energy Zones**

Texas currently not only leads the nation, but also ranks fifth overall in the world with 9,528 MW of installed wind power capacity. Success with renewable generation in Texas is partially attributed to the RPS.

The RPS provides states with a mechanism to increase renewable energy generation using a cost-effective, market-based approach, by requiring electric utilities

**Table A.1: Summary of Estimated Costs for Transmission Facilities**

Costs	Native voltage	765 kV	Native voltage DC
Construction costs for transmission (2010 US\$ million)	13,865	15,099	12,662
Levelized annual costs (2010 US\$ million)	1,419	1,537	1,304
Annual costs (US\$/MW)	16	17	15
Adjusted production cost Savings (US\$/MWh)	41	43	42
Net total cost (US\$/MWh)	49	52	54

Source: Compiled from Midwest ISO 2008.

and other retail electricity service providers to supply a specified minimum amount of customer load with electricity from eligible renewable energy sources. In the case of Texas, this necessitates that each provider obtain a renewable energy capacity based on their percentage of market share of energy sales multiplied by the renewable capacity goal. The transmission expansion is a prerequisite to achieving these targets.

According to the ERCOT 2009 annual report (ERCOT 2010a), transmission investment in Texas would rise significantly in 2012 and 2013, mainly because of the increase of investments in new 345 kV rights-of-way in the region. More importantly, this expansion is primarily driven by the scale-up of renewable energy generation, especially wind power. For example, Texas has invested US\$5.78 billion for the new transmission since 1999, and currently US\$8.2 billion are being spent under the five-year plan, including US\$5 billion solely to accommodate 18,000 MW of wind power capacity. As of June 2009, 72,500 MW of new generation interconnection requests are under review, with 44,300

MW of wind (61 percent), 5,900 MW of nuclear (8 percent), 14,000 MW of natural gas (19 percent), 5,000 MW of coal (7 percent), and 3,300 MW of solar, biomass, and other (5 percent) (see figure A.3).

The Public Utility Commission of Texas (PUC) designated five zones as CREZs, as shown in Figure A.4, and the CREZ Transmission Optimization Study (CREZ TOS; ERCOT 2008a) looks into four different scenarios, with five sets of assumptions on wind capacity and new rights-of-way, in order to develop transmission plans to provide transfer capacity for wind generation.

Scenario 1 has two different subplans. Plan A is designed for a CREZ wind generation capacity of 5,150 MW, without possible reinforcement needed for the total wind generation capacity of 12,053 MW. The total cost of this plan is estimated at US\$2.95 billion, involving 2,309 km of 345 kV right-of-way and 327 km of new 138 kV right-of-way. Plan B is also developed under the assumption of a CREZ wind capacity of 5,150 MW, but considering reinforcement for the total wind capacity.

**Figure A.3: Transmission Investments, 2007–15 (i), and Cumulative Installed Capacity (MW), 2007–14 (ii)**

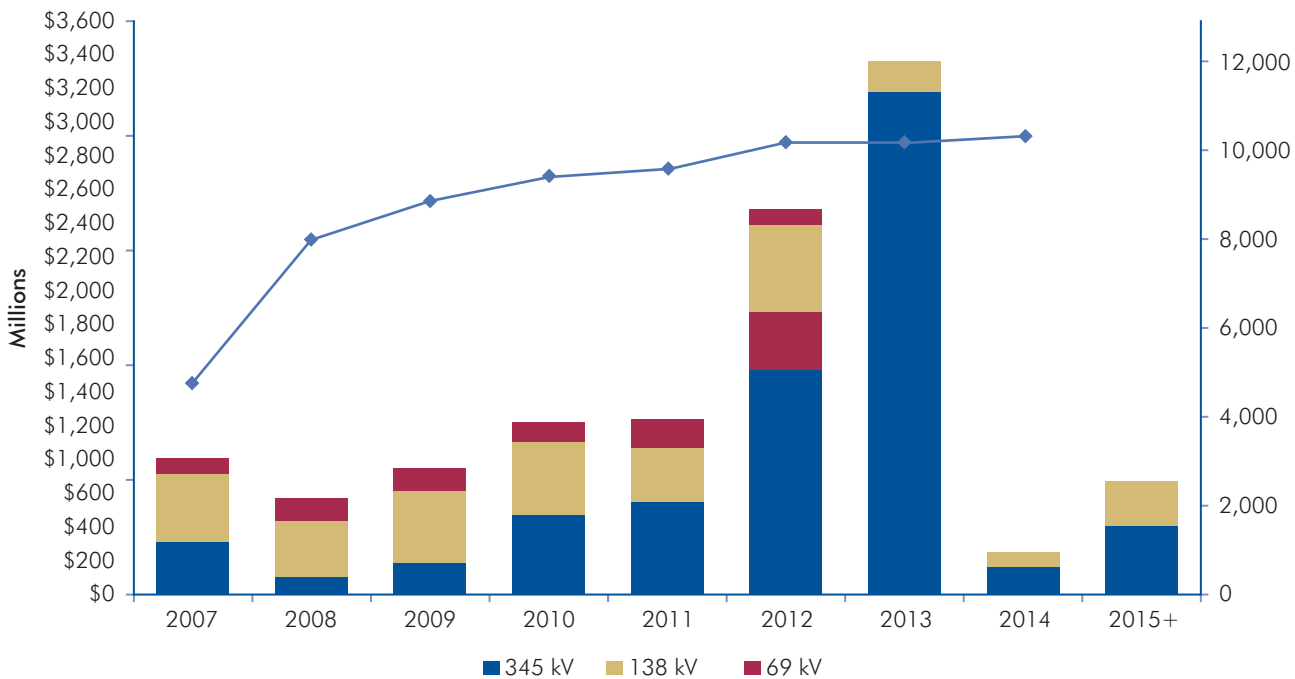

Source: (i) ERCOT2010a and (ii) ERCOT 2010b.

Note: (i) Numbers are based on projects being completed in the designated year and may not reflect actual investment in that year. Costs may be spread over several years; (ii) figures from 2011 to 2014 include cumulative planned capacity with a signed interconnection agreement.

**Figure A.4: Competitive Renewable Energy Zones (CREZs)**

PLEASE PROVIDE THE  
HIGH RES IMAGE

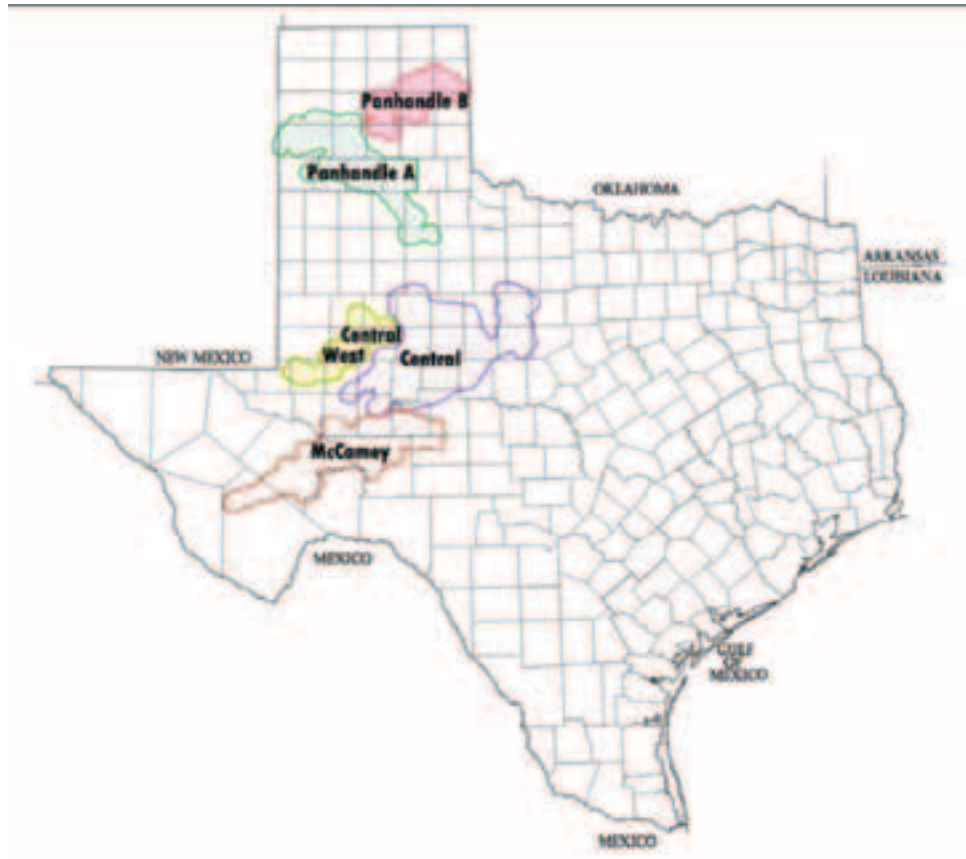

Source: ERCOT 2008a.

The estimated total cost of this plan is US\$3.78 billion, involving 2,879 km of new 345 kV right-of-way and 68 km of new 138 kV right-of-way. Scenario 2 with total CREZ capacity of 11,553 MW has a total cost of US\$4.93 billion. This plan involves 3,759 km of new 345 kV right-of-way and 68 km of new 138 kV right-of-way. For Scenario 3, the total wind capacity of 18,456 MW with CREZ wind capacity of 17,956 MW was assumed, and the total cost of this plan is estimated at US\$6.38 billion, involving 4,239 km new 345 kV right-of-way, 68 km of new 138 kV right-of-way, and 580 km of new high-voltage direct current (HVDC) right-of-way. As for Scenario 4, the cost with 17,516 MW of CREZ wind generation capacity assumed is estimated at US\$5.75 billion, involving 3,359 km of new 345 kV right-of-way, 68 km of new 138 kV right-of-way, and 580 km of new HVDC right-of-way. Table A.2 describes the core assumptions of each scenario analyzed in the CREZ study. In the end, after the review of this

CREZ Transmission Optimization Study, Scenario 2 was selected for the implementation.

### **United Kingdom**

To support and facilitate the growth of renewable energy, the United Kingdom has incorporated several policies and reform mechanism within their regulatory framework, which has served as the primary driver for the increased contribution of renewable energy. In 1989, the United Kingdom introduced the electricity reform and privatization process to bid out non-fossil fuel-generation technologies. This procurement mechanism remained active until 2002 when it was replaced by RO mechanisms. RO mechanisms set the first-ever target of 10 percent of renewable generation by 2010 in the United Kingdom. A few years later, the Climate Change Act of 2008 increased the target to 20 percent renewable generation by 2020. The latest targets are

**Table A.2: Estimated Investment Needs from the CREZ Study**

	Scenario 1-A	Scenario 1-B	Scenario 2 <sup>a</sup>	Scenario 3	Scenario 4
CREZ wind capacity (MW)	5,150	5,150	11,553	17,956	17,516
Total wind capacity (MW) <sup>b</sup>	12,053	12,053	18,456	24,859	24,419
Estimated investment needs (US\$ billion)	2.95	3.78	4.93	6.38	5.75
New rights-of-way (km)					
345 kV	2,309	2,879	3756	4,239	3,359
138 kV	327	68	68	68	68
HVDC	n.a.	n.a.	n.a.	580	580

Source: Compiled from ERCOT 2008a.

n.a. Not applicable.

<sup>a</sup> Selected option by CREZ TOS.

<sup>b</sup> Total wind capacity = CREZ wind capacity + base case wind 6,903 MW.

part of a framework to curb GHG emissions to 80 percent by 2050 as compared to the 1990 emissions.

For the past 20 years, the RO mechanisms have been the main driver behind the growth of renewable energy with biomass and wind power being the main contributors to this growth. As of 2008, total production of electricity from renewable sources accounted for 6 percent of the total generation. It is expected that this value could reach the level of 31 percent, overtaking the target of 20 percent by 2020, provided that existing power plants are closed in line with existing retirement dates (DECC 2009). Figure A.5 displays the increase in renewable energy in the United Kingdom from 1996 to 2008.

With increasing renewable energy generation, the needs for the transmission network to accommodate the increased capacity are also being addressed in the United Kingdom. The U.K. transmission system is owned and maintained by three regional monopoly transmission companies: (a) National Grid Electricity Transmission (NGET) in England; (b) Scottish Power Transmission Limited (SPT) in southern Scotland; and (c) Scottish Hydro-Electric Transmission Limited (SHETL) in northern Scotland. NGET also serves as the system operator for the U.K. system. The transmission sector is regulated and overseen by OFGEM.

Under the existing regulatory framework, every five years the transmission companies submit their capital and operational expenditure plans to the regulator. The

regulator assesses each plan through various audits and technical studies conducted by third parties. Once transmission companies respond to the assessment, the regulator issues the final decision on the allowed capital and operation expenditures for the transmission utilities for a regulatory period of five years. The operational and capital expenditures are converted into annual revenues that the companies are allowed to generate by applying transmission charges to network users.

The rapid increase in renewable energy as a result of the RO mechanisms in 2002 has triggered considerable investment requirements in transmission and distribution. The greater investment requirements specific to the United Kingdom are the result of interconnecting wind power generated in the north (Scotland) and transmitted to the main consumption centers in the south. In 2004, the regulator approved a £500 million interim capital expenditure specifically to accommodate the significant investment transmission needs triggered by renewable energy (OFGEM 2004) through a special capital expenditure approval. In 2006, when the allowed revenues for transmission companies for the period 2006–12 were under assessment, it became evident that investment in transmission needed to be scaled up. The approved capital expenditures for the three transmission companies for the 2006-12 period more than doubled from £1,676 million to £3,786 million compared to the previous period. For the SPT, where most of the wind power potential is located, their approved capital expenditures tripled. Table A.3

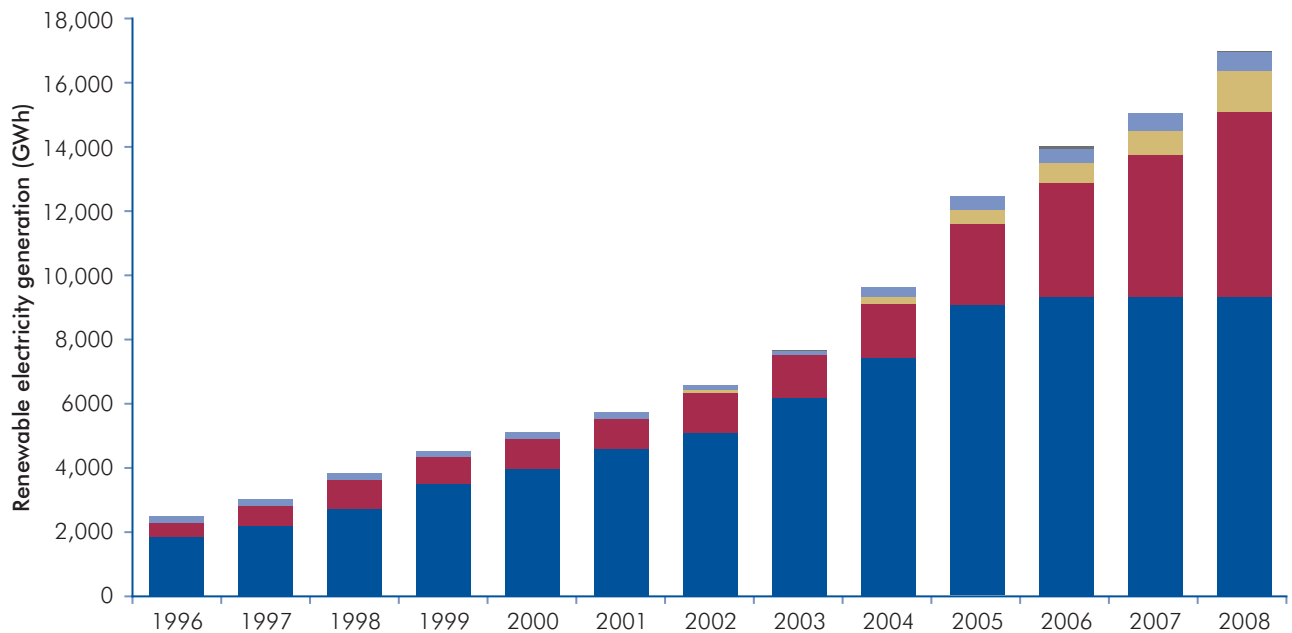
**Figure A.5: Renewable Electricity Generation in the United Kingdom**

Source: U.K. Department of Energy and Climate Change 2009.

details the levels of transmission investments and capital expenditures in the United Kingdom during the periods 2002–07 and 2007–12.

### European Union

In order to continue the development and deployment of renewable energy technologies, the European Union adopted the 2009 Renewable Energy Directive, which included a 20 percent renewable energy target by 2020 for the European Union (Figure A.6). In 2020, according to the Renewable Energy Directive's 27 National Renewable Energy Action Plans, 34 percent of the European Union's total electricity consumption should come from renewable energy sources, including 495 TWh from wind energy representing levels equivalent to 14 percent of consumption (EWEA 2011).

In 2009, despite the economic crisis, renewable energy technologies accounted for 61 percent of new electricity generating capacity connected to the grid. This strong growth of renewable electricity sources, especially wind energy and solar PV (see Figure A.7), has started to challenge the electricity system in countries such as Germany and Spain. More often, wind turbines in some regions are switched off during periods with high winds,

**Table A.3: Approved Capital Expenditures for the Three U.K. Transmission Companies**

Approved capital expenditures (£ million)	NGET	SPT	SHTL	Total
Regulatory period 2002–07	1,453	152	71	1,676
New regulatory period 2007–12	2,997	608	181	3,786
Percentage change	106	300	155	126

Source: OFGEM 2006.

Note: Values in 2005/2004 prices.

because their electricity cannot be integrated into the grid because of bottlenecks in the transmission network. For this reason, renewable electricity surpluses are not always transferred to another region with demand. The grids must be urgently extended and upgraded to foster market integration and maintain the existing levels of the system's security, but especially to transport and balance electricity generated from renewable sources,

**Figure A.6: Renewable Energy Share Targets of the European Countries**

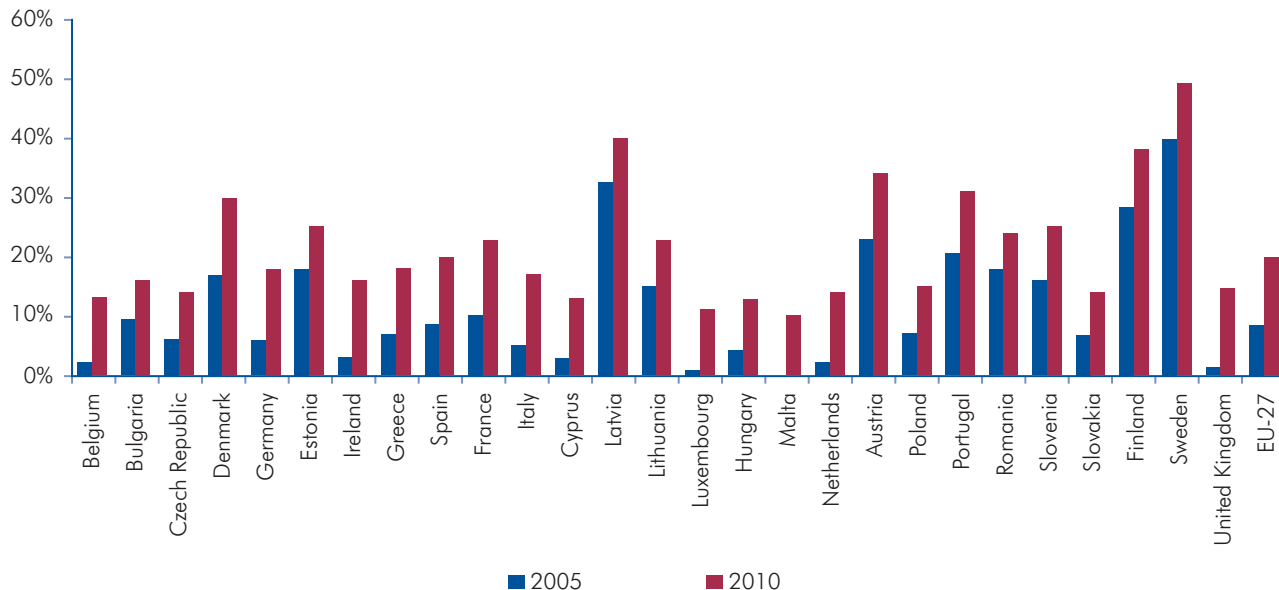

Source: European Commission 2011.

which is expected to more than double during the period 2007–20. A significant share of generation capacities will be concentrated in locations farther away from the major centers of consumption or storage. Up to 12 percent of renewable generation in 2020 is expected to come from offshore installations, notably in the northern seas. Significant shares will also come from ground-

mounted solar and wind parks in Southern Europe or biomass installations in Central and Eastern Europe, while decentralized generation will also gain ground throughout the continent(European Commission 2010).

The European Commission (2010) estimates that about €1 trillion must be invested in energy system between

**Figure A.7: New Installed Capacity per Year, 1995–2010 (MW)**

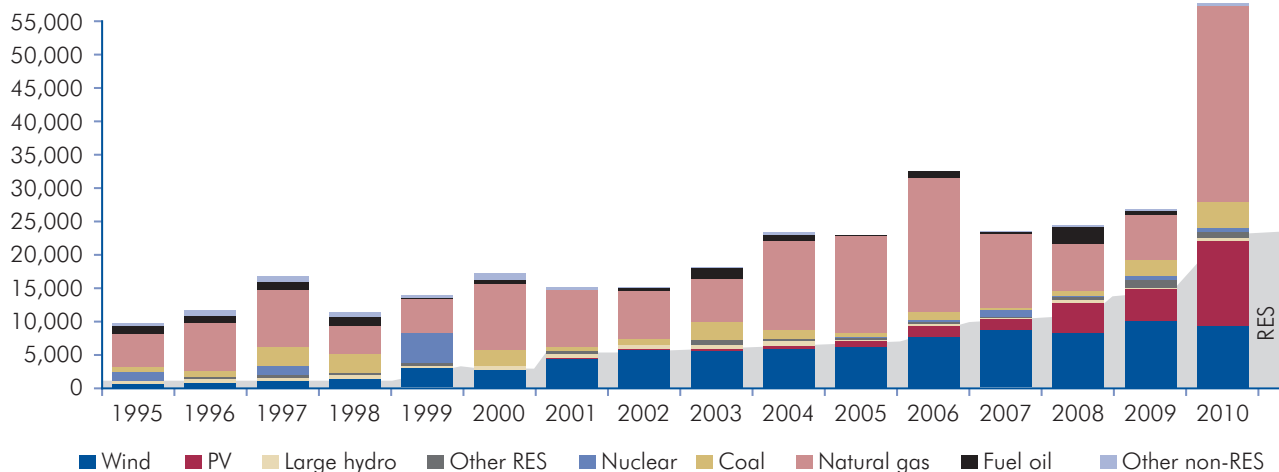

Source: EWEA 2011.

**Figure A.8: Grid Model Mapping Used by Energynautics Grid Study, Status 2010**



Source: Energynautics 2010.

2010 and 2020 in order to meet its energy policy objectives and climate goals. Out of this investment, approximately €200 billion are needed for energy transmission networks alone. Looking into electricity transmission investment specifically, according to the European grid study (Energynautics 2010; see Figure A.8), depending on various scenarios, the investment needs in transmission for renewable energy would range from €50 billion to €70 billion for 2030 with 2,537 TWh generation (65 percent) from renewable energy sources out of total generation of 3,886 TWh, and from €124 billion to €149 billion for the 2050 grid with 4,517 TWh (99 percent) generation from RES out of total generation of 4,543 TWh.

### **Mexico**

While the Government of Mexico has been increasingly supporting the development of renewable energy

projects by allowing private participation in the generation sector since 1992, specific targets for renewable energy generation in the electric power sector were introduced in 2010 by the National Energy Strategy (Secretaría de Energía 2010). The strategy, approved by congress in February 2010, pursues three main objectives: (a) improving energy security by increasing oil production and oil products reserve margins; (b) increasing economic efficiency and productivity by reducing losses in improving efficiency of the oil refining sector, reducing losses in the electricity sector, and further improving the electricity access rate to 98.5 percent; and (c) improving environmental sustainability by increasing renewable energy participation in the generation sector and improving end-user energy consumption.

For the last objective, the strategy set a target for the participation of renewable generation technologies,



including large hydropower. The target includes achieving a 35 percent share of renewable energy in terms of generation by 2024. The share of renewable generation technologies in 2008 (CFE 2010) was 23.7 percent, from which 21.7 percent was hydroelectricity, 1.8 percent geothermal power, and 0.2 percent wind power.

One of the richest wind resource areas in Mexico is located in the southeastern state of Oaxaca. The area has long-been named La Ventosa, whose translation to English is "The Windy." The wind power potential has been estimated between 5,000 MW and 6,000 MW, and the wind resource in the area is of high quality and can lead to capacity factors of up to 40 percent (Figure A.9).

Currently only 84.65 MW of wind power capacity are operational in the area, but projects in operation will increase to 2,745 MW by 2014 in the area. The majority of these projects (1,967 MW) will be owned and operated by the private sector under the self-supply

figure. That is, these projects supply large industrial consumers at privately negotiated energy prices. When consumers are located in a remote location, private generation producers are required to pay a transmission charge to the CFE, the vertically integrated utility that owns and operates the entire transmission and distribution networks in the country. Such increasing interest in developing wind-based self-supply generation projects in the region triggered the need for important expansion to existing transmission network. The main reason for the need to increase transmission capacity was that consumption centers were not located in the vicinity of the wind resource area, and the existing high-voltage network was not equipped to evacuate the generation from the new additions.

Figure A.10 depicts the existing transmission system in the central and southeastern parts of the country. The reinforcement required to evacuate 1,967 MW of wind self-supply projects consists mainly of a new 400 kV

**Figure A.9: Wind Speeds in La Ventosa Region Located in the Southeastern State of Oaxaca**

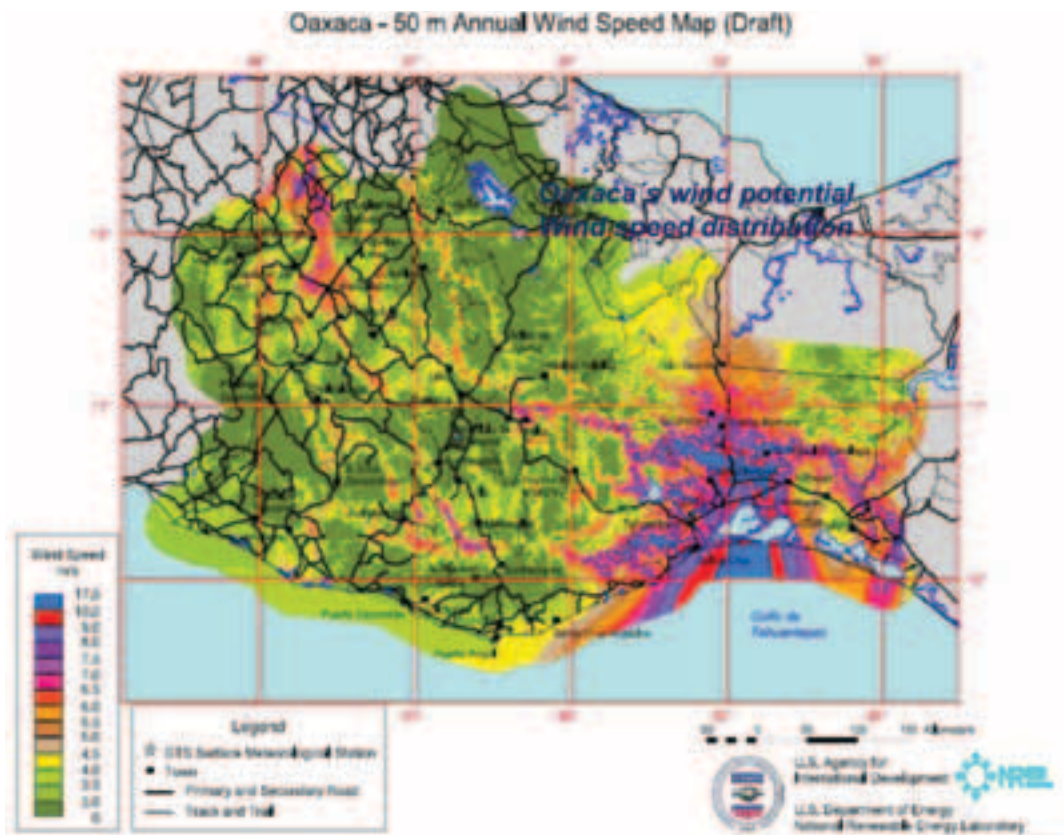

Source: F. J. Barnes, "An Open Season Scheme to develop Transmission Interconnection Investments for large wind farms in Mexico," Washington DC, 2009.

**Figure A.10: Existing Transmission Network and New Transmission Needs in La Ventosa Region**



Source: F. J. Barnes, "An Open Season Scheme to develop Transmission Interconnection Investments for large wind farms in Mexico," Washington DC, 2009.

double circuit line connecting La Ventosa region with the main trunk lines of the national interconnection system, reinforcement of the main trunk line with an additional 400 kV circuit, a substation where most wind power production will be collected, and a static var compensator to improve reactive power control. The total cost of these investment needs is estimated at US\$260 million.

### **Panama**

While the Government of Panama has not established specific targets for penetration levels of renewable energy technologies, the government has increased its support to such technologies through the approval of different incentives. Law 45, approved by congress in 2004, set forth a set of incentives for small power generation projects with renewable energy technologies, including hydro, geothermal, wind, solar, and other renewable energy technologies. The law established three main types of incentives for small renewable energy producers whose capacity is equal to or below 10 MW. First, direct contracting is allowed for energy supply from small renewable energy producers and the regulated distribution utilities or the transmission company. Second, the law introduced fiscal incentives, such as exemption of import taxes and direct fiscal incentives based on an evaluation of avoided CO<sub>2</sub>

emissions. Last, the law introduced an important incentive consisting of eliminating any transmission or distribution charge for small renewable energy producers whose capacity is below 10 MW. The law includes the same incentive for projects whose capacity is at or below 20 MW, but the exemption applies for the transmission and distribution charges applicable to the first 10 MW.

The total installed generation capacity in Panama in 2009 was 1,771 MW, of which 881 MW came from large and SH plants, and the rest from fossil fuel-fired generation (data from CEPAL 2010). The first wind power plant in Panama, the 120 MW Toabre project, is expected to enter into operation in late 2011. The transmission system in Panama is developed and operated by Empresa de Transmisión Eléctrica S.A. (ETESA), a state-owned transmission-only company.

Panama has especially rich hydro and minihydro renewable energy resources. While other sources, such as wind, are expected to increase their participation, small minihydro generators are the technology sources representing an increasing challenge for the transmission company.

After Law 45 had been approved, a large number of minihydropower projects in the basins of the rivers Chiriquí, Chiquiri Viejo, and Piedra have requested

interconnection to ETESA's lower-voltage transmission network. The basins have a number of minihydro projects that are in advanced stages of preparation. In aggregate, there are 21 projects whose capacities vary from a few megawatts up to 20 MW, representing a total of 172.2 MW. Figure A.11 depicts the relative locations of such projects to existing and proposed transmission infrastructures.

In order to interconnect these projects, the transmission company's expansion plan considers the expansion of caldera substation—green (S) in the upper right corner in Figure A.11—and the addition of a new substation—yellow (S) in the center. The objective of these substations is to serve as collectors of a number of minihydro projects in these areas.

The expansion at caldera substation involves adding a new 34.5 kV bay with a 50 MVA 115/34.5 kV transformer. The substation will collect, at 34.5 kV, the output of the SH projects in the region. The new substation Boqueron 3 will host a 230/34.5 kV

transformer to collect the projects in the central area of the figure. This substation will connect to the 230 kV system at a point between the Mata de Nance and El Progreso substations. Altogether, the cost of these transmission expansions adds up to US\$12.29 million, which is about 10 percent of the total investment needs of the company for the period 2008–12 (authors' calculations with data from ETESA 2009, p. 299).

### Egypt

In February 2008, the Supreme Council of Energy of Egypt, headed by the prime minister, approved a plan to generate 20 percent of the total energy generated from renewable sources by 2020. For such ambitions targets, the Government of Egypt is considered a champion of renewable energy in the region. Egypt's current energy portfolio mix consists mainly of hydro, wind, and thermal generation as shown in Table A.4.

To achieve this goal, the Egyptian Electricity Holding Company (EEHC) and New and Renewable Energy

**Figure A.11: Mini-Hydro Sites and Existing and Proposed Substations. Panama Chiriquí Region**



Source: ETESA 2009.  
 Minihydro Sites: yellow arrows; existing substations: green; proposed substations yellow; substations: S.

**Table A.4: Installed Capacity in Egypt as of 2009**

Source	MW	%
Hydro	2,800	11.8
Wind	430	1.8
Thermal	20,529	86.4
<b>Total</b>	<b>23,759</b>	<b>100</b>

Source: Sustainable Development Department Middle East and North Africa Region, World Bank.

Authority (NREA) are executing a number of renewable generation projects, especially focusing on wind and solar energy. As shown in figure A.5, in the first five-year phase (FY07–12), NREA plans to add 600 MW in wind power and 140 MW in hybrid solar thermal technology generation. In addition, an investment strategy for the following five years (FY12–17) is also being strategically pursued, which includes adding 3,600 MW in wind power and 150 MW in concentrated solar power technology.

To satisfy the significant investment requirement for wind power generation, Egypt is pursuing a wind commercialization program that will focus on engaging the private sector in phases. The first stage is through competitive bidding where the EETC is inviting private developers to design, finance, own, and operate private wind power projects and sell all electricity generated to the national grid. A 250 MW installed capacity wind project at the Gulf of Suez is planned to be commissioned by December 2013 through such a competitive bidding process, and the remaining 1,000 MW will be commissioned by the end of the year. The remaining wind power generation will be implemented through both competitive bidding and FITs.

**Table A.5: Wind and Solar Expansion Plan (MW)**

Sources	FY07–12	FY12–17
Wind	600	3,600
Solar	140	150
<b>Total</b>	<b>740</b>	<b>3,750</b>

Source: Sustainable Development Department Middle East and North Africa Region, World Bank.

Similar to wind, commissioning tests for the first 140 MW integrated solar combined-cycle power plant is currently under way. Additionally, two 100 MW solar thermal power plants and four photovoltaic plants with total capacity of 20 MW are under preparation by NREA.

These wind and solar projects, which are part of the FY07–12 five-year investment plan, have obtained financing commitments and are at various stages of construction. As of June 2010, NREA has installed 530 MW of wind energy capacity with about 1,000 MW in the pipeline.

In addition to executing a number of projects, the regulators are also using a policy and regulator mechanism to meet their targets. To further facilitate the growth of renewable energy and reduce investment risk—especially for wind energy developers, the EETC and distribution companies are required to sign a power purchase agreement with all licensed renewable plants connected to their network to purchase all energy generated from the first 20-year period. Additionally, regulators in Egypt are also incentivizing the renewable energy project developers through the following:

- Exemption of imported renewable equipment from custom duties compared to 5 percent customs duties for conventional equipment.
- Government allocation of more than 7,600 square kilometers of land for renewable projects.
- All permits for land allocation and utilization have already been obtained by NREA.
- Qualified developers can sign a use of land agreement with NREA, with zero leasing fees.
- For the competitive bidding, the EETC will purchase all energy generated for 20–25 years, and the government will provide guarantee for payments.
- All historic wind data are available for all developers (more than 10 years).

Furthermore, the new electricity law—in the process of ratification—will provide the legal framework for the creation of an electricity market in Egypt. This includes the establishment of the TSO through ownership unbundling from the holding company and guaranteeing third party access to both the transmission and distribution networks. The necessary regulations, including the tariff process, incentive regulation, market surveillance, and assurance of implementation of unbundling criteria, as well as

quality of service regulations, are under development by the Egyptian Electric Utility and Consumer Protection Regulatory Agency (EgyptEra).

By contrast, a number of barriers must be overcome for Egypt to successfully grow and meet its renewable targets. These barriers include the following:

- High wind speed is concentrated in specific areas very far away from loads, which requires huge investments in transmission systems to be built specifically for wind farms.
- Lack of regulations to encourage renewables (such as codes, access tariffs, supplementary agreements, and connection agreements).
- Incentives for purchasing renewable energy.

By addressing the barriers above and strategically pursuing renewable energy projects, involving the private sector, and initiating policies geared toward attracting investors to renewable projects, Egypt can continue to outpace neighboring Middle East and North African countries, while pragmatically approaching its 20 percent by 2020 target.

The Wind Atlas of Egypt identifies several geographic regions with wind resource potential, including along the Gulf of Suez, large regions of the Western and Eastern Deserts (in particular west and east of the Nile Valley) and parts of Sinai Peninsula. The wind resources are particularly high along the Gulf of Suez and comparable to those of the most favorable regions in northwestern Europe. In view of this favorable resource base, the Gulf of Suez has been chosen for scaling up wind power development in Egypt.

One of the projects supported by the World Bank and currently under way is the 250 MW, build-own-operate (BOO) transmission project that will connect the future wind parks at Gulf of Suez and Gabel El-Zait to the national transmission network (Figure A.12).

As displayed on the map, the desired location for developing wind farms is away from the demand, as well as the existing transmission infrastructure. Connecting this site to the existing network would require miles of transmission line, multiple substations, and various other relevant components.

**Figure A.12: BOO Transmission Project in Egypt**

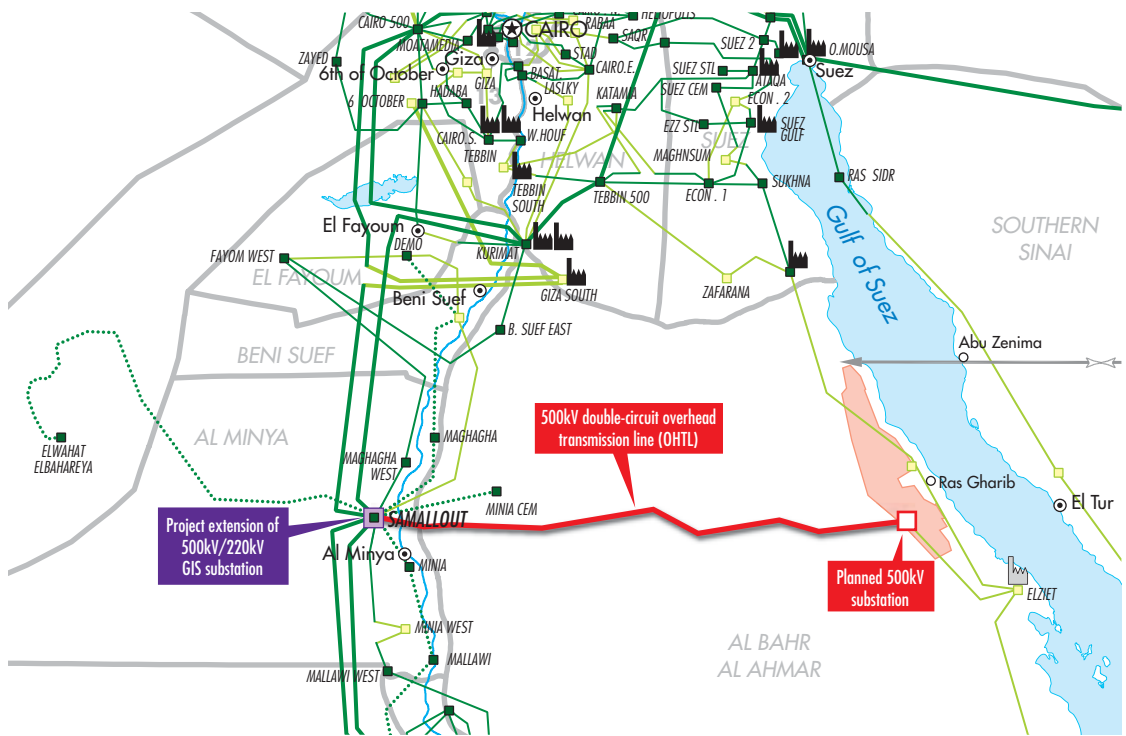

Source: World Bank.

**Figure A.13: Transmission Infrastructure for Renewable Project in Egypt**

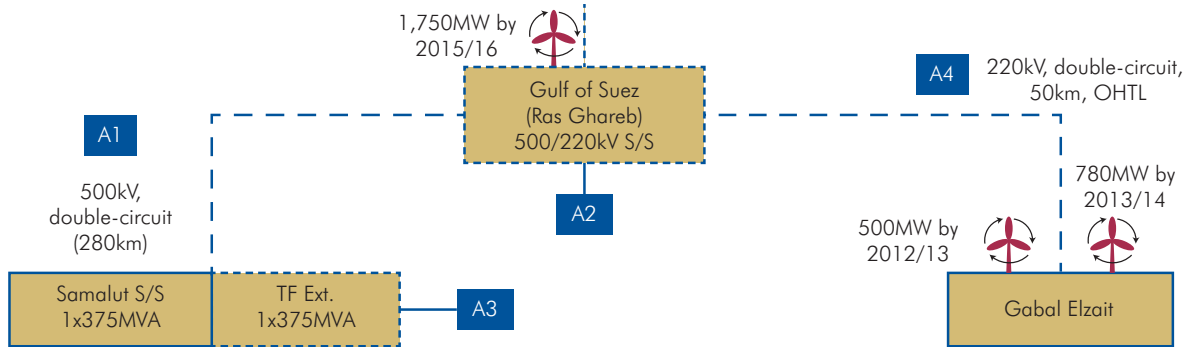

Source: World Bank.

As displayed in the diagram below (Figure A.13), the transmission line would first connect the wind farm from the Gulf of Suez (Ras Ghareb) using a 500 kV double circuit line over a distance of 280 km to Samalut (A1). Second, a 500 kV/220 kV GIS substation at the Gulf of Suez would be constructed and connected to the wind farm (A2). Third, extension of Samalut 500 kV/220 kV conventional substation would be constructed and connected (A3). Last, a double-circuit, 220 kV line from the Gulf of Suez (Ras Gharib) to Gabel El-Zait would be constructed to bring the second wind farm on board.

The total cost of this project is estimated to be US\$795.9 million, of which transmission costs are estimated at US\$299.7 million. However, this investment in transmission will also accommodate the future wind farm efforts in the Gulf of Suez and Gabal El-Zait, not just the 250 MW project currently under way. In total, the transmission built through this investment will accommodate 1,750 MW and 540 MW capacity planned in the Gulf of Suez and Gabal El-Zait, respectively.

### Brazil

Brazil has one of the world's cleanest energy matrixes, with 85.3 percent of overall energy production coming from hydro and other renewable sources (the worldwide average is 16 percent), and with 75 percent of the country's 105,000 MW installed generation capacity coming from hydropower plants.

In the last five years, two other renewable resources have become competitive and increased their share in

the generation mix: biomass from sugarcane bagasse cogeneration, and hydro plants smaller than 30 MW (SH). Hundreds of bagasse cogeneration and SH plants, totalling 5,200 MW, are already in operation, and an additional 2,700 MW are under construction. These plants entered the market through participating in centralized energy auctions for contracts with Brazilian distribution companies to supply their loads, in direct competition with all other generation sources (such as gas, coal, and large hydropower). More recently, wind power has emerged as the fourth "asset" of the country's "renewable portfolio," with 800 MW already in operation and under construction, plus a successful 1,800 MW contracting auction conducted in December 2009.

One of the most promising sites for renewables in Brazil is the Center-West region, which includes parts of the states of Mato Grosso do Sul and Goiás. As shown in the following figures, there are hundreds of candidate bagasse cogeneration and SH projects spread over 200,000 km (Figure A.14).

The challenge to integrating these small renewable projects comes from two factors: first, their dispersed location and, second, their distance to existing distribution or transmission networks.

The investment needs to integrate about 80 biomass (sugar bagasse) cogeneration and SH plants, resulting in 4,100 MW, were at about US\$400 million. The costs correspond to 2,500 km of networks, out of which 1,550 km are 230 kV lines, 960 km are 138 kV lines, and some are 230 kV circuit reinforcements in the main transmission network.

**Figure A.14: Some of the Renewable Candidate Projects in Mato Grosso do Sul**

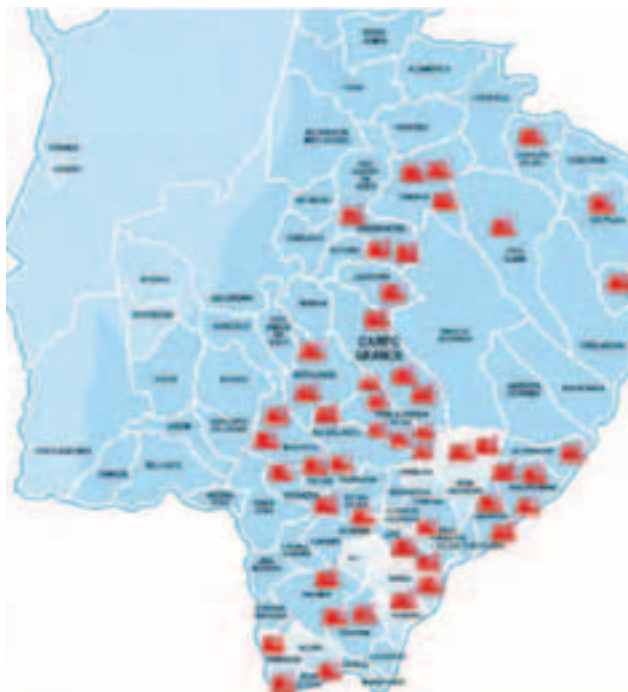

Source: World Bank 2010.

## The Philippines

The Philippines recently enacted important regulations that will bolster the participation of renewable energy into its islanded power system. The Philippines is well known to have tremendous potential for wind, hydro, and other renewable energy sources (Table A.6).

In order to decrease the country's dependence on fossil fuels, increase energy security by using local energy resources, and reduce emissions, the government approved the Act Promoting the Development, Utilization and Commercialization of Renewable Energy Resources (Congress of the Philippines 2008). The act, known as the Renewable Energy Act (Congress of the Philippines 2008) provides an institutional framework and general guidance to foster the development and utilization of renewable energy in the Philippines.

The Renewable Energy Act (Congress of the Philippines 2008) provides an institutional framework and general guidance to foster the development and utilization of

**Table A.6: Potential Renewable Generation Capacity per Grid (MW)**

	Luzon	Visayas	Mindanao
Wind	11,381	2,527	455
Small hydropower	1,291	58	978
Biomass	44	168	24
Geothermal	380	700	120
<b>Total</b>	<b>13,096</b>	<b>3,453</b>	<b>1,577</b>

Source: The authors and del Mundo and others (2003).

renewable energy in the Philippines. Advancing that the development of transmission networks to connect the renewable energy potential would represent an important challenge, the act made some specific provisions. Sections 11 and 18 state the following:

Sec. 11. *Transmission and Distribution System Development.* TRANSCO or its successors-in-interest or its buyer/concessionaire and all DUs shall include the required connection facilities for RE based power facilities in the Transmission and Distribution Development Plans: *Provided that such facilities are approved by the DOE[...].*

Sec 18. *Payment of Transmission Charges.* A registered renewable energy developer producing power and electricity from an intermittent RE resource may opt to pay the transmission and wheeling charge of TRANSCO or its successors-in-interest on a per-kilowatt-hour basis at a cost equivalent to the average per-kilowatt-hour rate of all other electricity transmitted through the grid.

In addition, Section 8 of the Rules and Regulations Implementing Republic Act No. 9513 (Republic of the Philippines—Department of Energy 2009) establishes similar provisions and adds considerations on the cost recovery of the connection facilities for renewable energy:

The ERC shall, in consultation with the NREB, TRANSCO, its concessionaire or its successors-in-interest, provide the mechanisms for the recovery of the costs of these connection facilities.

All these provisions are being designed in detail at the same time the main support scheme, FITs, for

renewable energy are being designed. The installed generation capacity of the three main islands in the Philippines is presented in Table A.7. As can be seen, hydro and geothermal power are the two main sources of renewable energy currently under operation. A first wind plant is already under operation in the Luzon Island, where wind power potential is the highest.

The World Bank conducted an assessment of the transmission investment needs to connect most of the projects that requested a services contract in the Luzon area. While Luzon is only one of the three main islands in the country, the transmission needs identified in that island serve as an important reference on the investment needs for renewable energy, given the importance of the island in terms of size and its renewable energy potential, especially wind power.

The first panel in Figure A.15 depicts the existing transmission network, while the second panel depicts the location of potential renewable energy projects in the area. The locations are depicted in gray, and the colored circles are the location of existing substations in the transmission network at different voltage levels. The locations are obtained directly from developers' applications to develop the sites. This application process is called a Service Contract in the context of Philippine regulations.

The potential projects include biomass, wind, and hydropower for a total of 589.4 MW. A transmission planning exercise was carried out, which concluded that transmission investment needs can be worth as much as US\$192 or US\$170 million, depending on the planning strategy followed to interconnect the project. The first amount corresponds to a scenario where each project is connected individually to

**Figure A.15: Philippine Bulk Transmission System and Map Showing All Renewable Candidate Projects and All Transmission System Substations in Luzon**

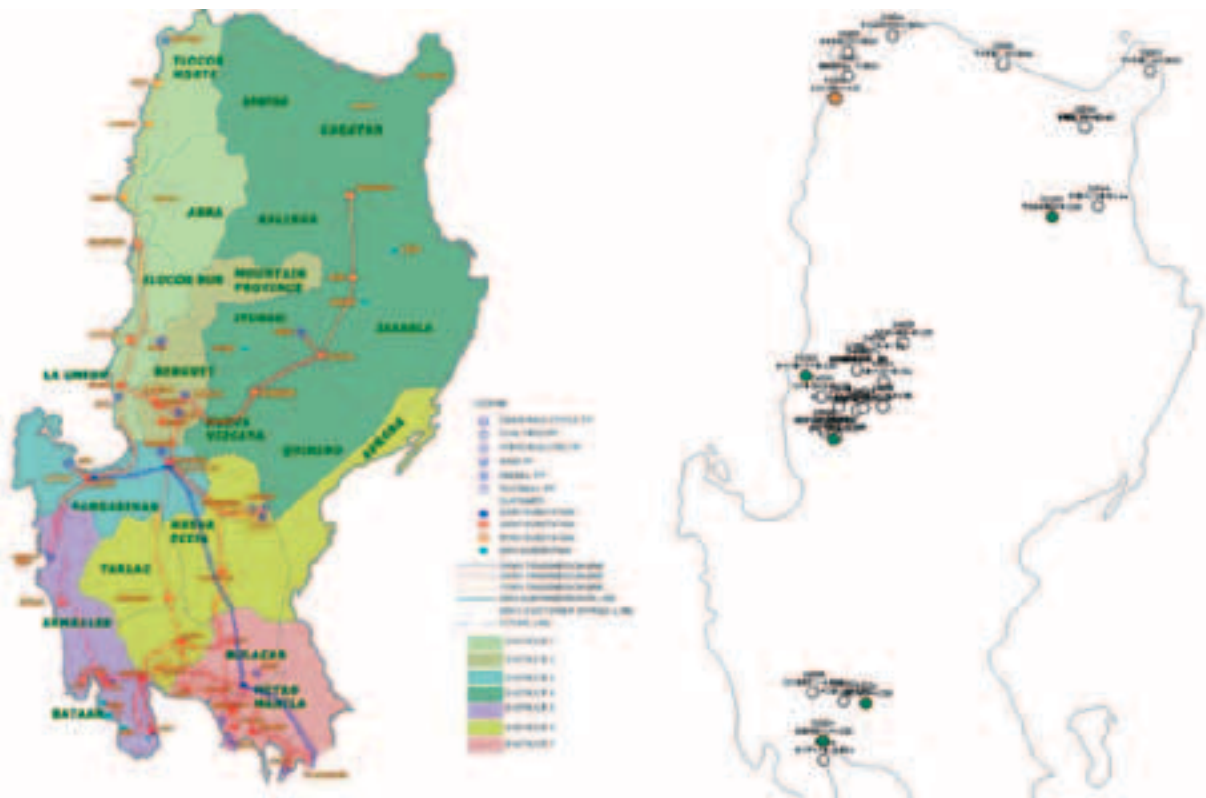

Source: World Bank 2010.



**Table A.7: Total Capital Expenditure Approved for the Transmission Company, 2005–10**

	2005	2006	2007	2008	2009	2010
Transmission	96.49	168.56	207.67	130.42	67.22	59.94
Non-network	14.28	15.40	15.45	15.21	11.42	11.63
Subtransmission+connection	3.42	4.13	10.22	10.95	1.87	2.08
<b>Total</b>	<b>114.19</b>	<b>188.09</b>	<b>233.34</b>	<b>156.59</b>	<b>80.51</b>	<b>73.64</b>

Source: The authors' calculations with data from ERC 2006.

Note: IMF exchange rates have been applied to convert PHP to USD.

the transmission network, and the second amount corresponds to the investment needs if planning is performed proactively for sets or clusters of projects located in different areas.

These investment needs can be contrasted with the total capital expenditures approved for the transmission company for the most recent regulatory period 2005–10.



## APPENDIX B: REVIEW OF CONNECTION COST ALLOCATION AND NETWORK INFRASTRUCTURE PRICING METHODOLOGIES

### B.1 Cost Allocation

#### Spain

Traditionally in Spain, all network connection costs for new generation were borne by the project developer. As costs have increased substantially—especially with the inception of offshore wind farms—the cost allocation structures in Spain have been adjusted. Currently, Spain has adopted a shallow cost allocation policy for its connection cost allocation structure, where all transmission network upgrades (reinforcement) costs are borne by the TSO and socialized—that is, they are financed through transmission tariffs paid by consumers. Project developers can speed up the process by paying the reinforcement costs upfront to the TSO and getting reimbursed later through consumer tariffs (SOU 2008). By contrast, the costs associated with the connection assets in Spain are typically borne by the project developer based on the agreement with the TSO. There are instances in which a semi-shallow cost allocation policy has been applied and the costs have been shared between the project developer and the TSO, although this is generally not the case and overall cost allocation policy remains shallow. In instances where multiple generations are connected in the same area, the costs for these reinforcements are shared between the different project developers according to the connected capacity.

#### Germany

Germany, similar to Spain, has incorporated a shallow cost allocation policy for cost allocation structures associated with connecting renewable generation to the existing transmission network. Project developers in Germany are responsible for all enabler facilities and system extension, while the TSO is responsible for all network upgrade (reinforcement) costs. The TSO is also responsible for all additional costs if it chooses to connect the renewable project elsewhere other than the closest existing grid connection. However, such is not the case when it comes to offshore wind parks that can warrant significant investment in system extension to connect with the existing network. Any wind park erected three nautical miles seaward in Germany is considered offshore. German regulators have incorporated a super-shallow

cost policy, where costs associated with network upgrades and system extensions inland for offshore wind parks are shared by all transmission companies (SOU 2008). All TSO costs for network upgrades are socialized and can be recovered through higher network consumer tariffs.

#### Denmark

Denmark, similar to Germany, uses a different strategy for onshore renewables and offshore wind parks. For all onshore renewable projects, Denmark has incorporated a shallow cost allocation policy. Project developers in Denmark are responsible for all enabler facilities and system extension costs to the nearest 10 kV point of electric system. The distribution system operator (DSO) and TSO are responsible for all network upgrade (reinforcement) costs, including all additional costs if they choose to connect the renewable project elsewhere other than the closest existing grid connection. For wind plants that are larger than 100 MW, the DSO generally provides a connection at a voltage above 100 kV, for which all interconnection and network upgrade costs are socialized (National Grid 2006).

For offshore wind farms, a super-shallow cost allocation policy is incorporated. However, unlike Germany, the Denmark offshore wind farm cost allocation policy transfers the cost of offshore substations to the TSO. Such policy further reduces the cost burden on generators, and it has contributed to high wind energy penetration in Denmark (National Grid 2006).

#### United Kingdom

The United Kingdom, which consists of Ireland, Scotland, England, and Wales, has incorporated a super-shallow cost allocation policy. All network upgrades, system extension, and some enabler facility costs are borne by the TSO. This is one of the shallowest policies in the European Union where the connection asset boundary is set very close to the generation, benefiting the renewable project developers from the low connection costs (Scott 2007). Connection costs in the United Kingdom are charged by imposing a connection charge component in the overall transmission charge methodology.

#### Texas

In the last 10 years, the wind industry in the United States has grown extensively, especially in Texas (Diften

2009). Texas regulators have incorporated a semi-shallow cost allocation policy to accommodate such growth and decrease the upfront investment costs for the renewable project developer. In Texas, “the individual electric utilities are responsible for building the transmission that is needed to interconnect a new generation facility.” However, the developer must pay a security deposit to protect the utility from developers backing out. The security deposit is returned to the developers once the generating plant is completed and ready to interconnect on time (Diffen 2009). In addition to the semi-shallow cost allocation, Texas has created CREZs, a process that “is intended to accelerate the building of transmission lines to allow renewable generation to get its power to markets that need it” (Diffen 2009). This approach, further elaborated later, identifies a group of generation to a common network that can reduce overall transmission costs and the cost of connections.

### Mexico

The vertically integrated utility in Mexico has no obligation to expand transmission networks, including connections and reinforcements for generation projects that will not be supplying public service demand. For all self-supply projects, Mexico has incorporated a deep policy for its cost allocation structure, whereby private project developers are responsible for all enabling facilities, system extension, and network upgrades costs. However, with the recent increase in wind energy generation in remote regions to supply private industrial clients requiring significant investment in transmission network expansion and upgrades, the CRE has instituted a process called Open Season. This process, similar to CREZs in Texas, allows the utility to identify transmission investment needs to serve all wind power projects in the region. Even though all costs are borne by the renewable energy producers, this process can greatly reduce the investment needs.

### Panama

To encourage the growth of small renewable energy producers, Panama has incorporated a super-shallow policy for developers of renewable projects with capacities of 10 MW or under. Renewable generators are responsible for enabling facilities, while the TSO bears the cost of network extension and upgrades. For developers of renewable projects above 10 MW, similar to Texas, Panama has opted for a semi-shallow cost

allocation policy. The TSO’s investment is ultimately reimbursed directly by government funds.

### Brazil

Brazil offers one of the cleanest energy mixes with 85.3 percent of overall energy being generated from renewable sources, such as hydro, biomass, sugarcane bagasse, and wind in 2009 (Farias 2010). Although large-scale hydropower generation projects are currently under way, smaller bagasse renewable generation has gained tremendous momentum because of its shorter ramp-up time, smaller investment, and lesser risk. However, from a transmission perspective, these projects pose a severe risk. Brazil has taken measures to optimize network expansion and reduce transmission costs (operational and losses) with the help of a combinatorial optimization algorithm. This has led to the advent of an integration network with shared connection links through collector stations at different voltages. Such networks eliminate the need for each generator to develop and pay for individual grid connection. Instead, generators bear the cost of enabling facilities and system extension up to the shared network. The costs associated with the shared network are allocated to each generator based on usage. This point is further discussed in the following section.

### The Philippines

The Philippines is well known for its tremendous potential for renewable energy resources. To facilitate and advance the growth of renewable energy, increase energy security, and decrease fossil fuel dependence, the government has approved the Renewable Energy Resources Act (Congress of the Philippines 2008). This act provides an institutional framework and general guidance to foster the development and utilization of renewable energy in the Philippines. The act makes specific reference to the issue of transmission and provides general guidance to change current regulation and incorporate a semi-shallow cost allocation policy for renewable developers. The transmission company (TRANSCO) is responsible for planning and connecting renewable energy projects throughout the nation, as well as financing and building the interconnection. The investment costs for system extensions are recouped later through monthly installments from the generator or other cost recovery mechanisms. Feed-in tariffs, however, design for specific sites that incorporate some incentives for transmission interconnection costs for

renewable developers that are under consideration. Based on the approval of RA 9513, regulators in the Philippines are contemplating changes in the existing shallow policy.

## Egypt

The transmission network in Egypt is publicly owned and operated by the Egyptian Electricity Transmission Company (EETC), which serves nine distribution companies and in turn provides electricity to 23.7 million customers. The Egyptian government has set an ambitious target of 20 percent renewable energy in its energy portfolio by 2020, and government agencies are currently working on policies and measures to encourage the growth of renewable energy, especially to accommodate wind energy for which the desirable high wind speed areas are concentrated away from the load and which require significant transmission investments. Current interconnection cost allocation practice can be considered shallow, since generators are responsible for enabling facilities, as well as system extension up to shared networks. Shared networks are being developed by the EETC, which should in turn recoup the costs from transmission tariffs. Regulators in Egypt, similar to regulators in the Philippines, understand the transmission challenges posed by renewable generation and are currently in the process of implementing final regulations on transmission pricing and final interconnection rules for wind power.

## B.2 Review of Network Infrastructure Pricing Methodologies

**Postage Stamp Method:** This is the simplest pricing methodology where a flat rate is charged based on the amount of energy transmitted or injected into the network. The rate can be derived in the following two ways:

- *Energy-based consumption generation:* Allocating costs for consumers and generators based on the annual megawatt-hours of consumption and generation, regardless of the peak usage (PJM Interconnection 2010). Transmission UoS charges for a user can be calculated simply by dividing megawatt-hours injected or extracted by the particular user by total annual megawatt-hours transmitted in the network and multiplying that fraction with the total transmission costs (see Table B.1). For renewable energy technology whose power production is intermittent leading to

a low capacity factor, UoS charges calculated on the basis of amount of usage (MWh) are more advantageous.

- *Peak-based demand or generation:* This method also spreads the costs to all users irrespective of location. However, the costs are based on their maximum amount of load (demand peak) or generation (system capacity peak). The second formula in Table B.1 illustrates the concepts of postage stamp pricing based on megawatt ratios. With regard to renewable energy, calculating on the basis of peak generation is less favorable because of the low capacity factor. For a wind or solar power plant, where capacity factors range between 20 and 35 percent of the name plate capacity, the generator would pay for capacity that is rarely used. Because of their variability, these technologies would be adversely affected by a peak or name plate capacity postage stamp method

**Usage Based Methods:** This method refers to when the infrastructure pricing is based on a measure of the burden it is placed on the network by the user.

**Table B.1: Basic Formulas for Various UoS Charge Methodologies**

### Formula for postage stamp method

$$\begin{aligned} \text{Energy-based (MWh): } R_t &= TC \cdot (P_{t(e)} \div P_{s(e)}) \\ \text{Peak-based (MW): } R_t &= TC \cdot (P_{t(p)} \div P_{s(p)}) \end{aligned}$$

### Formulas for usage basis

Formula for flow basis:

$$R_t = \sum_{alk} C_k \cdot (|f_{k(t)}| \div f_k)$$

Formula for distance-based MW-mile:

$$R_t = \sum_{alk} C_k \cdot (|G_{u(t)}| \div G_u)$$

where

$$G_u = D_k \cdot f_k$$

List of variables:

- $R_t$  transmission price for transaction T
- $TC$  total transmission charges
- $P_{t(p)}$  peak power of transaction
- $P_{s(p)}$  total system peak power generation
- $P_{t(e)}$  energy of transaction
- $P_{s(e)}$  total system energy generation
- $D_k$  distance (length of line)
- $C_k$  cost of circuit k
- $f_{k(t)}$  k-circuit flow caused by transaction
- $f_k$  k-circuit capacity

Usage-based charges are commonly determined in the following two ways:

- *Flow-based*: Two power flow analyses are used to determine the change in flows in the network with and without the generator or demand in question. The changes in flow are considered the “extent of use” of such particular generator or demand of the network. Network costs for a particular user are prorated based on the extent of use and can be expressed by the equation shown in Table B.1 (Pérez-Arriaga n.d).
- *Distance-based MW-mile*: While there are several variations of usage-based methodologies, one that is of special impact for renewable energy is when the “extent of use” metric includes a distance component. For instance, in a longitudinal power network, it is clear that a transaction over a long distance will require additional infrastructure needs and cause more pressure on the system. For this reason, the applicable charges reflect the added cost of distance. A MW-mile transmission pricing method can incorporate the length of each transmission element into the flow-based ratio as described in Table B.1.

### **Network Pricing Practices in various Jurisdictions**

#### **Spain**

Spain, as well as 13 other European countries, does not allocate any transmission UoS charges to the generators. Consumers are responsible for bearing 100 percent of transmission usage charges based on the postage stamp methodology (CEPA 2011). This creates a favorable situation for the renewable developers, since they are responsible for bearing only shallow connection costs.

#### **Germany**

Germany, similar to Spain, does not levy any UoS charges on generators. All charges are passed on to the demand consumers (load) based on a methodology that falls into the postage stamp method. The costs levied on load vary based on voltage level and utilization time, but do not include any locational signal (Wilks and Bradbury 2010). This has been one of the drivers behind the success of Germany’s renewable energy penetration. However, most of the development of

renewable energy generation has been in the north away from the demand in the south. To accommodate north-south power flow, significant reinforcement of the grid is required (Scott 2007).

#### **Denmark**

Regulators in Denmark have adopted a postage stamp transmission UoS methodology based on the amount of usage (MWh) and not peak generation (MW). In this case, demand customers (load) are responsible for 98 percent of the costs, and the remaining 2 percent is borne by the generators, creating a favorable situation for the generators. Unlike network connection cost allocation, there is no special treatment for offshore wind farms when it comes to UoS charges; however, renewable energy projects are largely exempt from UoS (Scott 2007).

#### **United Kingdom**

Regulators in the United Kingdom have adopted a hybrid policy that includes locational and residual UoS charges. The locational charges are based on generation zones and reflect the long-term marginal cost of transmission services within those zones (Wilks and Bradbury 2010). Similar to Germany, renewable generation in the United Kingdom is strong in the north, while the demand is in the south. Since generators are responsible for 27 percent of the locational UoS charges, being located in the north creates an unfavorable situation for many renewable developers. However, locational charges also serve as a signal to renewable developers to develop future projects in the south closer to demand (Scott 2007). Since locational charges typically do not fully recover all UoS costs, residual charges based on flow-based usage charges are also levied on the customer (load and generation) and calculated on the basis of the “extent of use” using power flow models (National Grid 2011).

#### **Texas**

The transmission UoS charges are fully allocated to the demand consumers (load). Currently, charges on demand are levied based on zonal usage reflecting the short-term energy prices within the five pricing zones (Wilks and Bradbury 2010). In addition to the zonal charges, which only recoups a fraction of transmission costs, UoS charges are determined using a postage

stamp methodology (Public Utility Commission of Texas, or PUC). Similar to Germany, Spain, and 11 other EU member states, generators in Texas are responsible only for shallow connection costs.

## Mexico

Historically, Mexico had incorporated a flow-based usage transmission pricing methodology for self-supply bilateral transactions. Generator’s charges would be based on determining the extent of network usage by a particular transaction using load flow modeling. This methodology led to transaction charges that had been perceived as inadequate for renewable energy producers, given that they are unable to change their location. To accommodate and encourage renewable energy, the Energy Regulatory Commission approved a new methodology that introduces a new flat-rate tariff per megawatt-hour. The rate (see Table B.2) is applied for up to two voltage levels that the transaction covers. These rates are lower compared to average transmission prices paid by European transmission networks users. However, the difference in the case of Mexico is that deep network connection cost allocation policy is applied to wind power developers. It needs to be noted that wind power development has taken place under a self-supply scheme, and the transmission system is owned and operated by the vertically integrated utility.

## Panama

The methodology in Panama has a locational (by zones) differentiation of tariffs, where in each zone the tariffs are determined based on the flow-based usage methodology. The methodology determines the extent of use for each customer (generator and load) based on the impact the power injection or extraction has

on the flows in the network at each point (ASEP). The generators bear 70 percent of the cost, while the load bears the remaining 30 percent. Load flow studies are utilized to compute the impacts. For small renewable projects under 10 MW, Panama does not allocate any transmission network usage cost to generators. Instead, all operational and maintenance costs are absorbed by the TSOs.

## The Philippines

The Philippines uses a postage stamp methodology applied in equal amounts to consumption and generations on megawatt-hour-based methodology. Anticipating the potential need to change transmission pricing rules for renewable energy, the recently approved Renewable Energy Act mandate (Congress of the Philippines 2008) provides guidance to the regulators on price transmission services for variable renewable energy in a per-megawatt-hour basis and recognizes that cost recovery of interconnection play a major role in the economic viability of remotely located generation projects.

## Brazil

Regulation applicable to the transmission sector in Brazil allocates the transmission UoS costs to both generation and demand based on flow-based usage methodology. In the case of small-scale renewable generation, the network is not part of the national interconnected transmission system or the distribution concessionaries assets. Cost allocation for small-scale renewable developers utilizing the integrated network with shared connections is based on distance-based MW-mile usage methodology. Low-flow simulations are used to determine the extent of use of the shared network and chargers are appropriately allocated.

## Egypt

In Egypt, the energy tariffs are bundled for consumers, and there are no separate charges for transmission UoS. However, regulators are currently working on new regulations to include transmission usage pricing. Table 2.6 summarizes the main characteristics of the interconnection cost allocation policies and the network pricing policies utilized in the countries. It is evident that shallower interconnection cost policies combined with no, or little, network costs allocation to generation are present in countries that have been highly successful

**Table B.2: Flat-Rate UoS, Mexico**

Voltage level	Transmission charge
High voltage Above or equal to 69 kV	US\$2.4296/MWh
Medium voltage Above 1 kV, but below 69 kV	US\$2.4296/MWh
Low voltage At or below 1 kV	US\$4.8592/MWh

Source: CRE 2010.

in integrating large amounts of renewable energy. While such success cannot clearly be attributed directly to the transmission policy, it is evident that these countries have made an effort to reduce such barriers. The following chapter of the report will analyze how

transmission planning has a great role to play to reduce transmission cost and to support one or the other pricing methodology.



## APPENDIX C: TOPICS ON TRANSMISSION PLANNING: RELIABILITY CRITERIA AND NEW TOOLS

Table C.1 contains a description of various models (building-blocks) that assist the transmission planning function.

Type of model	Some available models
<p><b>Long-term, optimization-based transmission models.</b> These models have the ability to systematically generate transmission expansion options for medium- and long-term timeframes (3–20 years). The models are based on optimization methods, and traditional objective functions are to find the lowest-cost network for a given target year, including its optimal evolution from the first year in the planning scenario. Some of the models usually perform combined generation and transmission planning. Network models are usually simplified and, for this reason, additional load-flow or dynamic models will be required to analyze the reliability of the network in the short term. Traditional inputs are load forecast, generation options, and transmission options with their technical and cost characteristics, as well as a description of the existing system. These types of models can be very useful to identify shared networks for renewable energy projects in a given geographical area.</p>	<p>OptGen Ventyx WinDS</p>
<p><b>Production simulation models.</b> The main difference between production simulation models and planning models, above, is that the former does not determine investment decision, only the optimal operation and dispatch of the network over a long term. The advantage of production simulation in the context of transmission planning and renewable energy is twofold. They can be used to estimate the economic benefits of proposed transmission additions. Transmission additions need to be included in the models based on planners’ experience or analysis or a clear identification of need (for example, reaching a renewable potential area or increasing transmission capacity in a given corridor). Simulating the operation of the system with and without the proposed interconnection will determine the economic impact of the network in terms of operational costs. Production simulation models have the capability to simulate the operation of the system with a time step of tens of minutes or hourly resolution. This resolution is very important for capturing the most important variability of wind and solar power, which occurs in the timeframe of minutes to hours.</p> <p>This simulation resolution is very helpful for capturing the variability of wind and solar resources. Production simulation models will be able to help decide if transmission is worth it for highly variable sources. For instance, the models can be used to determine when it is better to “spill” wind power than to build extra transmission. Traditionally production simulation models do not include detailed models of the network; rather, they focus only on real power. Losses can be considered in the model. Verifying that other system aspects, such as voltages and reactive power flows, are in technical compliance will require the use of additional models, such as load-flow models.</p>	<ul style="list-style-type: none"> <li>• SDDP</li> <li>• Ventyx PROMOD</li> <li>• EWIS Market Model</li> <li>• Powerworld</li> <li>• GTMax</li> <li>• EGEAS</li> </ul>

(continued on next page)

**Table C.1: Various Models That Assist with Transmission Planning** (continued)

Type of model	Some available models
<p><b>Load-flow models.</b> Load-flow models determine the state of the network during steady-state conditions. Load flow models include a detailed (nonlinear) representation of the network to determine how real and reactive power will flow in the network for a given generation and load condition. That is, they represent only a snapshot in time. Load-flow models are used to determine whether elements in the network are operating at their rated capacities, including load and voltages. These models are used to identify reactive power compensations needs that could be required and that cannot be identified by the models above. In addition, power flow models can be used to perform N-1 reliability analysis and identify whether the network is able to deliver load without reaching a level that may lead to unstable conditions. Load-flow models will provide an indication of whether more detailed dynamic simulation) models are required to further analyze conditions of overloads in the system. Load-flow models alone can be used to propose transmission expansions if the model is assembled for different expected conditions in future years. The model will be able to analyze the technical soundness of the proposal, but it will not be able to provide information on its costs and benefits.</p>	<ul style="list-style-type: none"> <li>• Siemens PTI – PSSE and MUST</li> <li>• GE – PSLF</li> <li>• Powertech PSAT</li> <li>• V&amp;R Energy POM-OPM</li> <li>• Powerworld</li> </ul>
<p><b>Short-circuit models.</b> Short-circuit models are used to determine currents in the network under short-circuit conditions. A proposed transmission expansion addition must be analyzed under short-circuit conditions to determine whether the short-circuit capacity of elements is within limits. These studies are especially used to determine currents in breakers and determine needed upgrades.</p>	<ul style="list-style-type: none"> <li>• Siemens PTI – PSSE</li> <li>• GE – PSLF</li> </ul>
<p><b>Specialized reliability evaluation models.</b> The models are used to determine reliability indicators of the generation and transmission system. Such reliability indicators are expressed in expected frequency of interruptions, loss of load probabilities, and so forth. Reliability evaluation models use enumeration, probabilistic, and Monte Carlo analysis, or other varied techniques to determine system reliability, given certain probabilities of equipment failure and unexpected events. Checking N-1 contingencies for a given set of probable events (line, generation outages) would constitute the simplest form of reliability evaluation, which can be performed by load-flow studies. Specialized reliability models go a step further by making automatic generating scenarios, considering statistical equipment failure rates to perform more comprehensive reliability evaluations.</p>	<ul style="list-style-type: none"> <li>• GE-MARS</li> <li>• Integral</li> <li>• Netomac</li> <li>• Digsilent</li> </ul>
<p><b>Dynamic simulation models.</b> These models are used to reproduce the dynamic time behavior of the power systems. These models are necessary to check that the system will remain stable for a number of possible contingencies. There are different angles to the stability of the power system, which include (a) angular or inertial stability, (b) voltage stability, and (c) frequency stability. The configuration and equipment in the transmission system has a great deal of influence in the stability of the system. Some expected failures may require that flow in lines be limited to a certain amount, which could in turn require more transmission. Reactive power control and stability are crucial for ensuring that losses are reduced and that voltages can remain within safe operational limits. Dynamic simulation models will identify potential additional investment needs to achieve stable condition, which could include reactive power compensation needs or needs, synchronous compensation, or improved voltage control. All stability studies are performed for a given condition of the network in the short term and require large amounts of data related to the characteristics of generation, load, and other equipment in the network. Dynamic studies require reliable data for meaningful results. The timeframe of these varied studies is from a few milliseconds to a few minutes.</p>	<ul style="list-style-type: none"> <li>• Siemens PTI – PSSE</li> <li>• GE – PSLF</li> <li>• Powertech TSAT, VSAT, SSAT</li> <li>• Digsilent</li> </ul>

Source: The authors.

The building blocks of the transmission planning function through the Planning Agency in Colombia are shown in Figure C.1.

**Figure C.1: Transmission Planning in Colombia: Methodology Building Blocks**

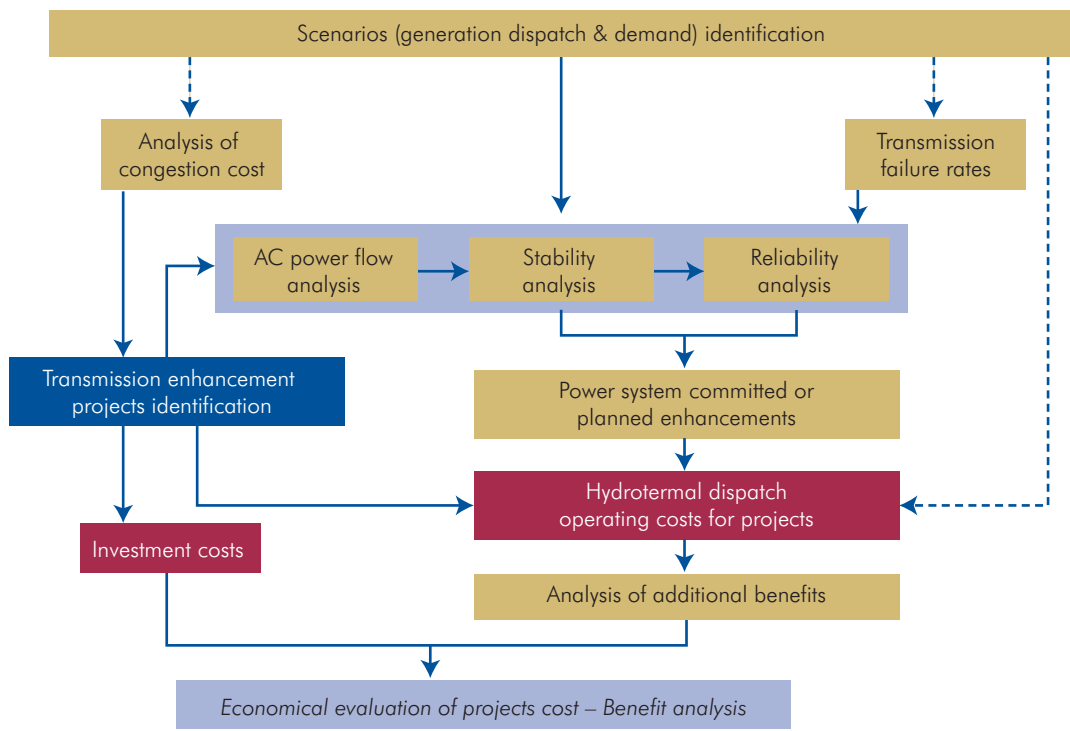

Source: XM Colombia 2009.

The building blocks of the technical transmission planning function in Mid-West ISO.

Midwest ISO’s planning process is fully compliant with the Planning Principles established by the Federal Energy Regulatory Commission’s (FERC’s) Order No. 890. In Order No. 890, the principles must be satisfied for a transmission provider’s planning process to be considered compliant with the rules: coordination, openness, transparency, information exchange, comparability, dispute resolution, regional participation, economic planning studies, and cost allocation for new projects.

**The planning process.** Planning principles that are set forth by the Midwest ISO Board of Directors are translated through the Planning Advisory Committee (PAC). PAC is formed to provide advice and direction to the Midwest ISO Planning Staff and Board of Directors Advisory Committee on policy matters related to the process, integrity, and fairness of the Midwest ISO-wide transmission expansion and implementation of cost allocation principles for transmission expansion.

A tier below, the Planning Subcommittee (PSC), which reports to the PAC, draws upon the collective knowledge of its transmission owner, transmission customer, and other industry participants to advise, guide, and provide recommendations to Midwest ISO planning staff in executing its planning responsibilities. This committee is responsible for stakeholder technical reviews of planning processes. A tier below the PSC are Sub-Regional Planning Meetings (SPM), instituted by FERC Order 890. They provide a forum for all stakeholders, including regulatory staff, to participate in an open and transparent planning process. While study assumptions and policies are dictated through the PAC and PSC, stakeholders at the SPMs get an opportunity to see study results directly and provide active feedback on identified issues and other related issues, and collaborate with Midwest ISO planning staff to propose the transmission expansions necessary to meet reliability and economic standards. Stakeholder participation at these forums is critical in successfully translating planning analysis results into transmission expansions consistent with Midwest ISO planning principles. Participation of state and federal regulatory

staff additionally helps in successful implementation of such plans. This is especially true in states where state regulatory approvals are needed for siting transmission lines. Upfront involvement of staff in the planning process helps ensure that by the time a transmission plan is in a state docket for siting permits, they are aware of all stakeholder issues, since they have been

tackled at various planning forums at Midwest ISO. Where needed, Midwest ISO staff also prepare and present testimony at state or federal courts, regulatory authorities, or other agencies.

Table C.2 presents some widely used reliability criteria.

**Figure C.2: High-Level Planning Process Flow Diagram**

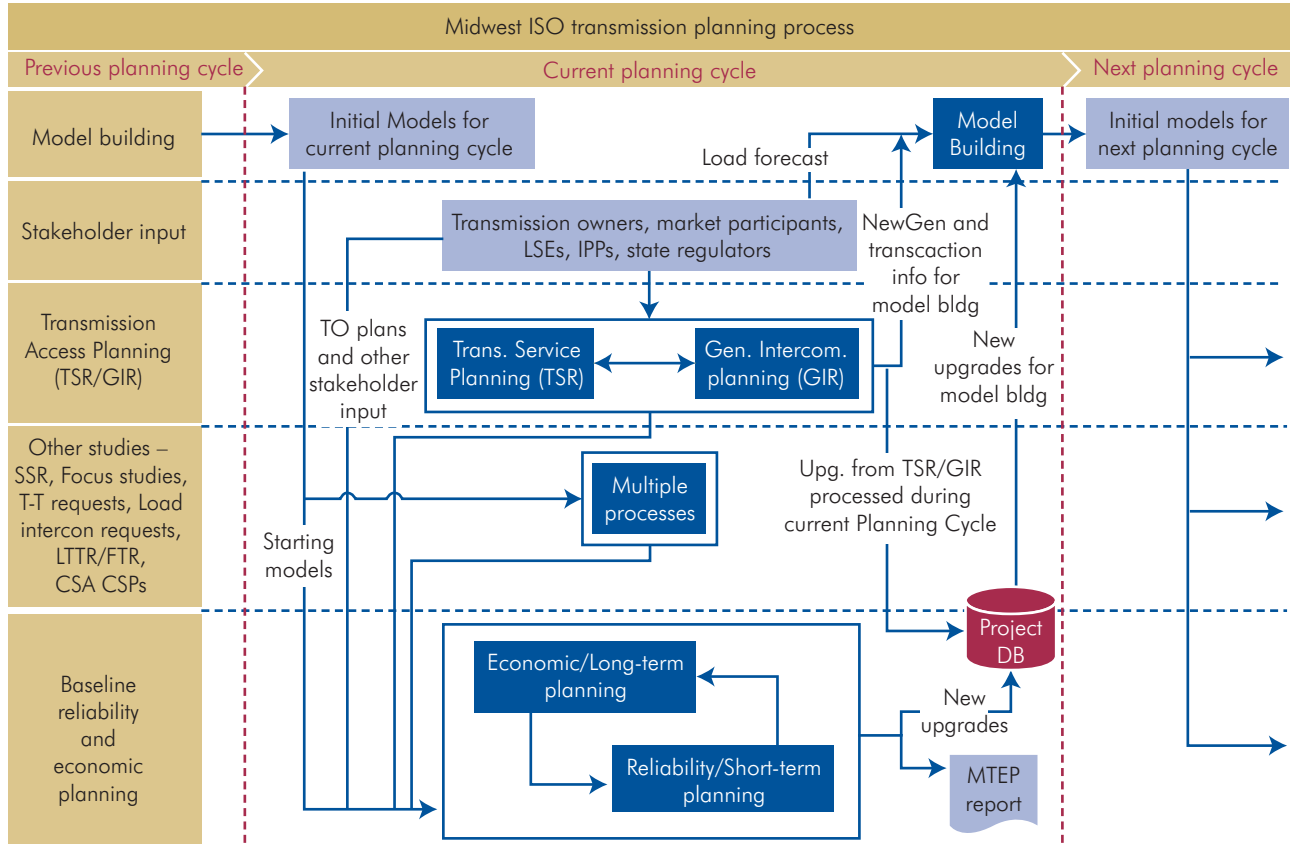

PLEASE CHECK THE FIGURE AS THE DATA HAS TO BE MANUALLY ENTERED.

**Table C.2: Some Widely Used Reliability Criteria**

State	Contingency	Criteria
Steady-state	<b>No contingency, normal conditions</b>	No system element with overloads All system load being served All voltages above 230 kV at +/-5 % All voltages below 230 kV at +/-10%
Steady-state	<b>Single contingency, N-1:</b> The loss of one system element (transmission line, transformer, generator) from previously screened contingencies	No system element with overloads System loss load less than 10%, except when contingency is a radial line-feeding load All voltages above 230 kV at +/-7 % All voltages below 230 kV at +/-10%
Steady-state	<b>Double contingency, N-1:</b> The loss of two system elements (transmission line, transformer, generator) from previously screened contingencies	No system element with overloads System loss load less than 10% All voltages above 230 kV at +/-7 % All voltages below 230 kV at +/-10%
Steady-state	<b>Short circuit:</b> Three- and single-phase to ground faults at major generators or substations	No circuit breaker reaches its current limit
Dynamic	<b>Short circuit:</b> Three- and single-phase faults at major generators, lines, and substation bus bars, freed in normal time by circuit breakers	All system generators retain angle stability, with minor load-shedding
Dynamic	<b>Single or double contingency:</b> Loss of major generator or transmission line	System frequency back to normal, allowing for under-load frequency shedding

Source: Various sources, prepared by the authors.

The following box presents the mathematical model of shared network planning as implemented by the PSR model in Box 3.2.

### Box C.1: PRS-Netplan Model for Designing Shared Networks for Multiple Projects in Renewable Zones

The problem is to identify the least-cost network expansion for a set of generators ( $\Omega_G$ ) seeking interconnection to the network. The first step is to compute the optimal network for year  $t = \tau F$ , after which all generators must be connected by solving the following optimization problem:

$$\text{Minimize } \{ \text{CAPEX}_{\Theta_i, t=\tau F} + \text{NPV}[\text{OPEX}_{\Theta_i, t=\tau F+1}, \text{OPEX}_{\Theta_i, t=\tau F+2}, \dots, \text{OPEX}_{\Theta_i, t=\tau F+v}]_{t=\tau F} \}$$

Subject to: power flow balance in each node (first Kirchhoff law);  
power flow limits in each circuit;  
discrete choices of conductor sizes for each circuit;

Where:

$W_G = \{G_1, G_2, \dots, G_N\}$	is the set of renewable generators seeking connection; $N$ is the number of generators; $G_i$ is the $i$ -th generator seeking connection; $\Theta_i$ is the $j$ -th subset of $\Omega_G$ ;
$A_{G_i} = \{(x, y)_i, \delta_i, P_i, \zeta_i\}$	attributes of generator $G_i$ : $(x, y)_i$ are the geographic coordinates (latitude, longitude); $\delta_i$ is year of commissioning; $P_i$ the installed power of $G_i$ [MW]; $\zeta_i$ is the estimated capacity factor.
$\Gamma_{\Theta_i, t}$	is the set of reinforcements to the transport grid needed for connecting any subset $\Theta_i$ of $\Omega_G$ to the transmission network in year $t$ [US\$];
$\text{CAPEX}_{\Theta_i, t} = \text{CAPEX}_{\Theta_i, t} \{\Gamma_{\Theta_i, t \leq \tau}\}$	are the capital expenditures (investments) in the connection facilities (facilities linking the generator to the bulk transmission system) of any subset $\Theta_i$ of $\Omega_G$ in year $t = \tau$ [US\$], which are a function of $\Gamma_{\Theta_i, t \leq \tau}$ (which indicates $\Gamma_{\Theta_i, t}$ occurred in every year $t \leq \tau$ );
$\text{OPEX}_{\Theta_i, t} = \mu_{L, t} \cdot L_{\Theta_i, t} + \mu_{E, t} \times E_{NS, \Theta_i, t}$	are the operational expenditures of the connection facilities (facilities linking the generator to the bulk transmission system) of any subset $\Theta_i$ of $\Omega_G$ in year $t$ [US\$];
$L_{Q, t} = L_{\Theta_i, t} \{\Gamma_{\Theta_i, t \leq \tau}, A_{\{G_i \in \Theta_i\}}\}$	are the energy losses at the connection facilities (facilities linking the generator to the bulk transmission system) of any subset $\Theta_i$ of $\Omega_G$ in year $t$ [MWh], which are a function of $\Gamma_{\Theta_i, t \leq \tau}$ and $A_{\{G_i \in \Theta_i\}}$ ;
$E_{NS, \Theta_i, t} = E_{NS, \Theta_i, t} \{\Gamma_{\Theta_i, t \leq \tau}, A_{\{G_i \in \Theta_i\}}\}$	is the energy not supplied because of the unavailability of the connection facilities (facilities linking the generator to the bulk transmission system) of any subset $\Theta_i$ of $\Omega_G$ in year $t$ [MWh], which are a function of $\Gamma_{\Theta_i, t \leq \tau}$ and $A_{\{G_i \in \Theta_i\}}$ ;
$\mu_{L, t}; \mu_{E, t}$	is the cost of energy used to value, respectively, $L_{\Theta_i, t}$ and $E_{NS, \Theta_i, t}$ in year $t$ [US\$/MWh];
$\text{NPV}\{ \cdot \}_{t=\tau}$	notation for the function net present value at year $t$ ;
$\tau_i$	year after which at least one generator of $\Omega_G$ must be connected to the network;
$\tau_F$	year after which all generators of $\Omega_G$ must be connected to the network;
$v$	service life of a given reinforcement or set of reinforcements to the transport grid.

Load flow equations are described by a linear model to facilitate solution by means of mixed integer quadratic programming. Losses are a modeled quadratic loss factor.

Given the set of reinforcements  $\Gamma_{\Theta_i, t=\tau F}$  defined in the model above, optimally allocate the reinforcements over time, in order to minimize the net present value of the sum of capital expenditures and operational expenditures that occurred in the time horizon  $\tau_1 \leq \tau \leq (\tau F + v)$ . This is accomplished by an additional module in NetPlan.

## BIBLIOGRAPHY

- CSP Today. 2009. *Global Concentrated Solar Power Industry Report 2010–2011*. CSP Today and Altran Technologies. London: FC Business Intelligence.
- Anastasia Papaioannou, April 7, 2008, KANTOR Management Consultants, “The Institutional Capacity Building of the Egyptian Electric Utility and Consumer Protection Regulatory Authority (EEUCPRA)—Price Regulation Report.” [http://www.egyptera.com/en/pdf/PriceReg\\_final\\_report.pdf](http://www.egyptera.com/en/pdf/PriceReg_final_report.pdf)
- ASEP. <http://www.asep.gob.pa/default.asp>.
- Baldick, Ross. 2010. “Wind and Energy Markets: A Case Study of Texas,” IEEE.
- BC Transmission Corporation. 2007. “Mandatory Reliability Standards.” Welcome to BC Hydro—Transmission Microsite. Vancouver, B.C., Canada: BC Transmission Corporation. [http://transmission.bchydro.com/transmission\\_system/reliability/mandatory\\_reliability.htm](http://transmission.bchydro.com/transmission_system/reliability/mandatory_reliability.htm)
- Beck, Fred, and Eric Martinot. 2004. “Renewable Energy Policies and Barriers. In *Encyclopedia of Energy*, ed. Cutler Cleveland. San Diego: Academic Press/Elsevier Science, pp. 365–83.
- BDEW (Bundesverband der Energie- und Wasserwirtschaft). 2007. *Transmission Code-2007 (Netzcodes und Richtlinien des BDEW)* Berlin: BDEW. [http://www.bdew.de/bdew.nsf/id/DE\\_7B6ERD\\_NetzCodes\\_und\\_Richtlinien](http://www.bdew.de/bdew.nsf/id/DE_7B6ERD_NetzCodes_und_Richtlinien)
- Berkeley National Laboratory. 2009. *The Cost of Transmission for Wind Energy*.
- Boccard, Nicolas. 2009, “Capacity Factor of Wind Power Realized Values vs. Estimates.” *Journal-Energy Policy*. February 26. [http://www.rocks.org.hk/activity2009/Capacity\\_factor%5B1%5D.pdf](http://www.rocks.org.hk/activity2009/Capacity_factor%5B1%5D.pdf)
- California ISO. 2010. “CAISO FERC Filings—2010.” Folsom, CA: California ISO. <http://www.aiso.com/2718/27189a5933dd0.html>
- C mac, Daniel, Ra l Bastidas, Ram n Nadira, Carlos Dortolina, and Hyde M. Merrill. 2009. “Transmission Planning in Developing Countries: Criteria and Risks.” IEEE PES 2009 Meeting, Calgary, July 28. [www.merrillenergy.com/TrPl.pdf](http://www.merrillenergy.com/TrPl.pdf)
- Cambridge Economic Policy Associates Ltd. 2011. *Review of International Models of Transmission Charging Arrangements—A Report for OFGEM*. Cambridge: Cambridge Economic Policy Associates Ltd.
- CEPA (Cambridge Economic Policy Associates Ltd.). 2011. “Review of International Models of Transmission Charging Arrangements: A Report for OFGEM.” London: CEPA, February. [http://www.Ofgem.gov.uk/Networks/Trans/PT/WF/Documents1/Project\\_TransmiT\\_-\\_CEPA\\_report.pdf](http://www.Ofgem.gov.uk/Networks/Trans/PT/WF/Documents1/Project_TransmiT_-_CEPA_report.pdf)
- CEPAL. 2010. *Centroam rica: Estad sticas del Subsector El ctrico, 2009*. M xico, D.F.: CEPAL. [http://www.eclac.org/publicaciones/xml/5/41665/2010-63-estad\\_subsector\\_electrico-L976.pdf](http://www.eclac.org/publicaciones/xml/5/41665/2010-63-estad_subsector_electrico-L976.pdf)
- CFE (Comisi n Federal de Electricidad). 2010. “Programa de Obras e Inversiones del Sector El ctrico 2010–2024.” Mexico, D.F.: CFE. [www.semarnat.gob.mx/temas/..ot/pre\\_sector\\_electrico\\_2010\\_2024.pdf](http://www.semarnat.gob.mx/temas/..ot/pre_sector_electrico_2010_2024.pdf)
- Chatterjee, D. 2010. “Expanding Transmission for Renewable Energy: Smart Planning and Cost Recovery Practices.” St. Paul, Minnesota: Midwest ISO. World Bank Workshop, Washington, D.C., June 24. [http://www.google.com/url?sa=t&source=web&cd=1&ved=0CUBUQFjAA&url=http%3A%2F%2Fsitere.sources.worldbank.org%2FINTENERGY2%2FResources%2F4114191-1284676341016%2FChatterjee.pdf&ei=oYEaTqrkOKqr0AHbh\\_mYCG&usq=AFQjCNGJMnD3YVnPxzTSEL2CfBnlqH9OeA](http://www.google.com/url?sa=t&source=web&cd=1&ved=0CUBUQFjAA&url=http%3A%2F%2Fsitere.sources.worldbank.org%2FINTENERGY2%2FResources%2F4114191-1284676341016%2FChatterjee.pdf&ei=oYEaTqrkOKqr0AHbh_mYCG&usq=AFQjCNGJMnD3YVnPxzTSEL2CfBnlqH9OeA)
- Congress of the Philippines. 2008. *Republic Act No. 9513—An Act Promoting the Development, Utilization and Commercialization of Renewable Energy Resources and for Other Purposes*. Manila, July.
- Couture, Toby D., Karlynn Cory, and Claire Kreycik. 2010. *A Policymaker’s Guide to Feed-in Tariff Policy Design*. Technical Report, NREL/TP-6A2-44849, July. Golden, Colorado: NREL. [www.nrel.gov/docs/fy10osti/44849.pdf](http://www.nrel.gov/docs/fy10osti/44849.pdf)
- Cross Texas Transmission. (2011). *CREZ Background*. Retrieved 05 15, 2011, from Cross Texas Transmission: <http://www.crosstexas.com/aboutcrez.htm>

- de la Torre, T., J. W. Feltes, T. Gomez San Roman, and Hyde M. Merrill. 1999. "Deregulation, Privation and Competition: Transmission Planning Under Uncertainty." *IEEE Transactions on Power Systems* 14(2):460–65.
- DECC (Department of Energy and Climate Change). 2009. 15 July 2009. *The UK Low Carbon Transition Plan—National Strategy for Climate and Energy*. Presented to Parliament pursuant to Sections 12 and 14 of the Climate Change Act 2008. Norwich, U.K.: TSO (The Stationery Office). [http://www.decc.gov.uk/assets/decc/White%20Papers/UK%20Low%20Carbon%20Transition%20Plan%20WP09/1\\_20090724153238\\_e\\_@@\\_lowcarbontransitionplan.pdf](http://www.decc.gov.uk/assets/decc/White%20Papers/UK%20Low%20Carbon%20Transition%20Plan%20WP09/1_20090724153238_e_@@_lowcarbontransitionplan.pdf)
- del Mundo, Rowaldo, Charito M. Isidro, Remife L. Villarino-de Guzman, and Fidelpio V. Ferraris, with inputs from Rafael Seña, Ina Pozon, and Liam Salter. 2003. *Power Switch! Scenarios and Strategies for Clean Power Development in the Philippines*. Quezon City: Kabang Kalikasan ng Pilipinas (WWF Philippines), University of the Philippines Solar Laboratory, and U.P. Electrical and Electronics Engineering Foundation.
- Diffen, Becky H. 2009. "Competitive Renewable Energy Zones: How the Texas Wind Industry Is Cracking the Chicken and Egg Problem." *The Rocky Mountain Mineral Law Foundation Journal* 46(1). <http://www.velaw.com/uploadedFiles/VEsite/Resources/CREZHowTxWindIndustry.pdf>
- CRE (Comisión Reguladora de Energía). 2010. "Resolución por la que la Comisión Reguladora de Energía expide la metodología para la determinación de los cargos correspondientes a los servicios de transmisión que preste el suministrador a los permisionarios con centrales de generación de energía eléctrica con fuentes de energía renovable o cogeneración eficiente." Resolución No. RES/066/2010. Mexico City: Comisión Reguladora de Energía. [http://dof.gob.mx/nota\\_detalle.php?codigo=5139525&fecha=16/04/2010](http://dof.gob.mx/nota_detalle.php?codigo=5139525&fecha=16/04/2010)
- DSIRE (Database of State Incentives for Renewables and Efficiency). 2011. "DSIRE: RPS Policies." Raleigh, NC: DSIRE. <http://www.dsireusa.org/summarymaps/index.cfm?ee=0&RE=1>
- Elliott, D., Schwartz, M., Scott, G., Haymes, S., Heimiller, D., and George, R. (2003). *Wind Energy Resource Atlas of Oaxaca*. National Renewable Energy Laboratory. National Renewable Energy Laboratory.
- Energinet.dk. 2010. "The Danish Windcase." Film. Fredericia, Denmark: Energinet.dk. <http://www.energinet.dk/EN/KLIMA-OG-MILJOE/the-Danish-windcase/Sider/Den-danske-vindcase.aspx>
- Energynautics. 2010. *European Grid Study 2030/2050*, 2010.
- Enernex. 2011. "Eastern Wind Integration and Transmission Study." Prepared for the U.S. National Renewable Energy Laboratory. [http://www.nrel.gov/wind/systemsintegration/pdfs/2010/ewits\\_executive\\_summary.pdf](http://www.nrel.gov/wind/systemsintegration/pdfs/2010/ewits_executive_summary.pdf)
- ENTSO-E (European Network of Transmission System Operators for Electricity). 2007. *Nordic Grid Code 2007*. <https://www.entsoe.eu/resources/publications/former-associations/nordel/planning/>
- ———. 2010. *ENTSO-E Overview of Transmission Tariffs in Europe: Synthesis 2010*. Working Group Economic Framework. ENTSO-E Association.
- ENTSO-E's Ten-Year Network Development Plan. *ENTSO-E—European Network of Transmission System Operators for Electricity*. <https://www.entsoe.eu/system-development/tyndp/>
- EPA. (2010, 10 07). *Renewable Portfolio Standards Fact Sheet*. Retrieved 05 15, 2011, from Environment Protection Agency: [http://www.epa.gov/chp/state-policy/renewable\\_fs.html](http://www.epa.gov/chp/state-policy/renewable_fs.html)
- ERC (Energy Regulatory Commission)—Philippines. N.d. "Definition and Boundaries of Transmission Connection Assets." Pasig City, Philippines: ERC. [http://www.erc.gov.ph/cgi-bin/issuances/files/Definition%20%20BoundariesTransmission%20Conection%20Asets\\_1.pdf](http://www.erc.gov.ph/cgi-bin/issuances/files/Definition%20%20BoundariesTransmission%20Conection%20Asets_1.pdf)
- ———. 2004. "Regulatory Reset for the National Transmission Corporation (TRANSCO) for 2006 to 2010." Issues Paper. Pasig City, Philippines: ERC. <http://www.erc.gov.ph/pdf/Issues%20PaperTWRG.pdf>



- ———. 2006. "Regulatory Reset for the National Transmission Corporation (TransCo) for 2006 to 2010: Final Determination." ERC Case No. 2005–041RC. Pasig City, Philippines: ERC. <http://www.erc.gov.ph/pdf/Final%20Determ%20v11%201of4.pdf>
- ERCOT (Electric Reliability Council of Texas). 2006a. *Analysis of Transmission Alternatives for Competitive Renewable Energy Zones in Texas*. Austin: ERCOT.
- ———. 2006b. System Planning. "CREZ Study Update, ERCOT TAC." Presentation November 2. Austin, Texas: ERCOT. [http://www.google.com/url?sa=t&source=web&cd=1&sqi=2&ved=0CUBUQFjAA&url=http%3A%2F%2Fwww.ercot.com%2Fcontent%2Fmeetings%2Ftac%2Fkeydocs%2F2006%2F1102%2F11.\\_CREZ\\_Presentation\\_to\\_TAC\\_110206.ppt&rct=j&q=complex%20meteorological%20and%20terrain%20model%20ERCOT&ei=5NUVTsOAJsTUgQfRypUf&usg=AFQjCNEGHsY4VxlfobPT6IVkliG6QZnfDw&sig2=pW9uLwzEJmLQ2ZDclv0yWA](http://www.google.com/url?sa=t&source=web&cd=1&sqi=2&ved=0CUBUQFjAA&url=http%3A%2F%2Fwww.ercot.com%2Fcontent%2Fmeetings%2Ftac%2Fkeydocs%2F2006%2F1102%2F11._CREZ_Presentation_to_TAC_110206.ppt&rct=j&q=complex%20meteorological%20and%20terrain%20model%20ERCOT&ei=5NUVTsOAJsTUgQfRypUf&usg=AFQjCNEGHsY4VxlfobPT6IVkliG6QZnfDw&sig2=pW9uLwzEJmLQ2ZDclv0yWA)
- ———. 2008a. *Competitive Renewable Energy Zones (CREZ) Transmission Optimization Study*. Austin, Texas: ERCOT.
- ———. 2008b. "CREZ Transmission Optimization Study Summary." Dan Woodfin, Director, System Planning, ERCOT Board of Directors. Austin, Texas: ERCOT. [http://www.ercot.com/meetings/board/keydocs/2008/B0415/Item\\_6\\_-\\_CREZ\\_Transmission\\_Report\\_to\\_PUC\\_-\\_Woodfin\\_Bojorquez.pdf](http://www.ercot.com/meetings/board/keydocs/2008/B0415/Item_6_-_CREZ_Transmission_Report_to_PUC_-_Woodfin_Bojorquez.pdf)
- ———. 2009. "System Planning Overview for Sunset 11-20-09." Austin, Texas: ERCOT. <http://www.ercot.com/news/presentations/2009/index>
- ———. 2010a. *2009 Annual Report*. Austin: ERCOT.
- ———. 2010b. "ERCOT Testimony to House Environmental Regulation Committee." Austin, Texas: ERCOT.
- ———. 2011. "ERCOT Quick Factsheet." Retrieved May 15, 2011, from Electric Reliability Council of Texas. Austin, Texas: ERCOT, March. <http://www.ercot.com/content/news/presentations/2011/ERCOT%20Quick%20Facts%20-%20March%202011.pdf>
- ———. 2011. "CREZ Progress Report No. 3 (April Update)." Prepared for the Public Utility Commission of Texas by RS&H. Austin, Texas: ERCOT, April. [http://www.texascrezprojects.com/systems/file\\_download.aspx?pg=324&ver=2](http://www.texascrezprojects.com/systems/file_download.aspx?pg=324&ver=2)
- ESMAP (Energy Sector Management Assistance Program). 2007. *Technical and Economic Assessment of Off-grid, Mini-grid and Grid Electrification Technologies*. ESMAP Technical Paper 121/07. Washington, D.C.: World Bank. <http://siteresources.worldbank.org/EXTENERGY/Resources/336805-1157034157861/ElectrificationAssessmentRptSummaryFINAL17May07.pdf>
- ETESA (Empresa de Transmisión Eléctrica S.A.). 2009. "Plan de Expansión del Sistema Interconectado Nacional 2009–2023." Panama: Gerencia de Planeamiento, November.
- European Commission. 2010. *Energy Infrastructure Priorities for 2020 and Beyond—A Blueprint for an Integrated European Energy Network*. Luxembourg: Publications Office of the European Union.
- ———. 2011. *Renewables Make the Difference*. Directorate-General for Energy. Luxembourg: Publications Office of the European Union.
- EWEA (European Wind Energy Association). 2011. *EU Energy Policy to 2050: Achieving 80–95% Emissions Reductions*. Brussels: EWEA, March.
- Farias, J. C. 2010. "Expanding Transmission for Renewable Energy Smart Planning and Cost Recovery Practices." Presentation, Empresa de Pesquisa (EPE), Washington, D.C.
- Frontier Economics Ltd. 2009. *International Transmission Pricing Review—A Report Prepared for the New Zealand Electricity Commission*. Frontier Economics Ltd., Australia.
- Hempling, Scott. 2009. "Postage Stamp Transmission Pricing: The Seventh Circuit Reverses FERC." National Regulatory Research Institute (NRRRI). An NRRRI Teleseminar Addressing *Illinois Commerce Commission, et al. v. FERC*, Nos. 08-1306, et al. (7<sup>th</sup> Cir. Aug. 6, 2009), October 1, 2009. <http://www.narucmeetings.org/Presentations/nrri%20postage%20stamp%20coursebook%20hempling%20sept%2009.pdf>
- IEA. 2011. *Clean Energy Progress Report 2011*. Paris: OECD/IEA.

- Imaz, Luis. "Transmission Grid Planning Process." [http://www.ree.es/ingles/accionistas/pdf/presentaciones/dia\\_inversor/transmission\\_grid\\_planning\\_process.pdf](http://www.ree.es/ingles/accionistas/pdf/presentaciones/dia_inversor/transmission_grid_planning_process.pdf)
- IPA Energy. 2008. "The Relative Economics of Wind Farm Projects in the Scottish Islands." To BERR, June 2008, IPA Energy + Water Economics, 41 Manor Place, Edinburgh, Scotland, [www.ipaeconomics.com](http://www.ipaeconomics.com).
- Jevons, W. Stanley. 1879. *The Theory of Political Economy*. London: Macmillan.
- Joskow, Paul L. 2010. "Comparing the Costs of Intermittent and Dispatchable Electricity Generating Technologies." MIT-CEEPR (Series); 2010-013. Cambridge, Massachusetts: MIT Center for Energy and Environmental Policy Research. <http://hdl.handle.net/1721.1/59468>
- Krause, Thilo. 2003. "Evaluation of Transmission Pricing Methods for Liberalized Markets—A Literature Survey." No. EEH\_PSL\_2003\_001. Zurich: Swiss Federal Institute of Technology Zurich, July 7. [http://www.eeh.ee.ethz.ch/uploads/tx\\_ethpublications/transmission\\_pricing.pdf](http://www.eeh.ee.ethz.ch/uploads/tx_ethpublications/transmission_pricing.pdf)
- López, E. C., and T. Ackermann. 2008. *Grid Issues for Electricity Production Based on Renewable Energy Sources in Spain, Portugal, Germany, and United Kingdom—Annex to Report of the Grid Connection Inquiry*. Stockholm: Statens Offentliga Utredningar.
- Lusztig, C., P. Feldberg, R. Orans, and A. Olson. 2006. "A survey of transmission tariffs in North America." *Energy* 31:1017–39. [http://www.sciencedirect.com/science?\\_ob=ArticleURL&\\_udi=B6V2S-4FTMM0X-1&\\_user=1916569&\\_coverDate=06%2F30%2F2006&\\_rdoc=1&\\_fmt=high&\\_orig=gateway&\\_origin=gateway&\\_sort=d&\\_docanchor=&view=c&\\_searchStrId=1696811272&\\_rerunOrigin=google&\\_acct=C000055300&\\_version=1&\\_urlVersion=0&\\_use rid=1916569&md5=533b7f1b1ab3e90fd09238339e41c653&searchtype=a](http://www.sciencedirect.com/science?_ob=ArticleURL&_udi=B6V2S-4FTMM0X-1&_user=1916569&_coverDate=06%2F30%2F2006&_rdoc=1&_fmt=high&_orig=gateway&_origin=gateway&_sort=d&_docanchor=&view=c&_searchStrId=1696811272&_rerunOrigin=google&_acct=C000055300&_version=1&_urlVersion=0&_use rid=1916569&md5=533b7f1b1ab3e90fd09238339e41c653&searchtype=a)
- Madrigal, M., and Energy and Environmental Economics. 2010. "Creating Renewable Energy Ready Transmission Networks: Highlights and Emerging Lessons from Selected Developed Country Experiences." Inception Paper. Washington, D.C.: World Bank.
- World Bank. 2010. "Transmission Expansion for Renewable Energy: Planning and Cost Recovery Emerging Practices with an Application to the Philippines." Washington, D.C.: World Bank.
- Mercados-EMI. 2009. "Pricing and Contracting Mechanisms for Renewable Energy Development in the Philippines." Prepared for the World Bank by Mercados—Energy Markets International, January 2009, MI 1110.
- Midwest ISO. 2008. "Regional Generation Outlet Study." Carmel, Indiana: Midwest ISO.
- ———. 2010a. "Attachment FF—Transmission Expansion Planning Protocol." *Midwest ISO Tariff Attachments*. <https://www.midwestiso.org/Library/Tariff/Pages/Tariff.aspx>
- ———. 2010b. "BPM 020—Transmission Planning." *Midwest ISO Business Practices Manuals*. <https://www.midwestiso.org/Library/BusinessPracticesManuals/Pages/BusinessPracticesManuals.aspx>
- ———. 2010c. "Regional Generation Outlet Study." Carmel, Indiana: Midwest ISO.
- Moreno, R., D. Pudjianto, and G. Strbac. 2010. "Future Transmission Network Operation and Design Standards to Support a Low Carbon Electricity System." IEEE PES 2010 General Meeting, Minnesota, July.
- National Grid. 2011. "The Statement of Use of System and Connection Charges." [http://www.nationalgrid.com/NR/rdonlyres/A80C2625-4812-47EB-8B5D-6425B7286E17/45715/UoSCI7R0Draft\\_Issued.pdf](http://www.nationalgrid.com/NR/rdonlyres/A80C2625-4812-47EB-8B5D-6425B7286E17/45715/UoSCI7R0Draft_Issued.pdf)
- NERC (North American Electric Reliability Corporation). 2009. *2009 Long-Term Reliability Assessment 2009–2018*. Princeton, New Jersey. [www.nerc.com/files/2009\\_LTRA.pdf](http://www.nerc.com/files/2009_LTRA.pdf)
- ———. "Reliability Assessments." NERC—North American Electric Reliability Corporation—2009 LTRA. <http://www.nerc.com/page.php?cid=4%7C61>
- NYISO. 2010a. "2010 NYISO Wind Generation Study." Rensselaer, NY: NYISO. [http://www.nyiso.com/public/energy\\_future/issues\\_trends/greening\\_the\\_grid/index.jsp](http://www.nyiso.com/public/energy_future/issues_trends/greening_the_grid/index.jsp)

- ———. 2010b. "2010 Reliability Assessment." Rensselaer, NY: NYISO (Markets and Operations—Services—Planning—Planning Studies). [http://www.nyiso.com/public/markets\\_operations/services/planning/planning\\_studies/index.jsp](http://www.nyiso.com/public/markets_operations/services/planning/planning_studies/index.jsp)
- Octaviano, Claudia A. 2010. "Estudio de Alternativas Metodológicas para la Valoración de Externalidades." Renewable Energy Assistance Program for Mexico, World Bank, Washington, D.C.
- OFGEM. 2006. Transmission Price Control Review: Final Proposals.
- OFGEM (Office of the Gas and Electricity Markets). N.d. London: OFGEM. <http://www.Ofgem.gov.uk/Networks/offtrans/rott/PublishingImages/Offtranimg2.jpg>.
- ———. 2004. "Transmission Investment for Renewable Generation: Final Proposals." Reference no. 288/04. London: OFGEM, December.
- ———. 2006. "Transmission Price Control Review: Final Proposals." Decision Document. Reference no. 206/06. London: OFGEM, December. [http://www.Ofgem.gov.uk/Networks/Trans/Archive/TPCR4/ConsultationDecisionsResponses/Documents1/16342-20061201\\_TPCR%20Final%20Proposals\\_in\\_v71%206%20Final.pdf](http://www.Ofgem.gov.uk/Networks/Trans/Archive/TPCR4/ConsultationDecisionsResponses/Documents1/16342-20061201_TPCR%20Final%20Proposals_in_v71%206%20Final.pdf)
- ———. 2009. "Regular Proposes Possible GBP1 Billion Injection into Green Grid Investment." London: OFGEM, November. Press Release: <http://www.Ofgem.gov.uk/media/pressrel/Documents1/TII%20DRAFT%20release%20final.pdf>
- ———. 2010a. "Project TransmiT: A Call for Evidence—Technical Annex." London: OFGEM, September. [http://www.Ofgem.gov.uk/Networks/Trans/PT/Documents1/Project\\_TransmiT\\_A\\_Call\\_for\\_Evidence\\_Technical\\_Annex.pdf](http://www.Ofgem.gov.uk/Networks/Trans/PT/Documents1/Project_TransmiT_A_Call_for_Evidence_Technical_Annex.pdf)
- ———. 2010b. "RIIO: A New Way to Regulate Energy Networks—Final Decision." Reference no. 128/10. London: OFGEM, October. <http://www.Ofgem.gov.uk/Networks/rpix20/ConsultDocs/Documents1/Decision%20doc.pdf>
- ———. 2011a. "Project TransmiT: Next Steps on Connections Issues." Reference no. 38/11. London: OFGEM, March. [http://www.Ofgem.gov.uk/NETWORKS/TRANS/PT/Documents1/110322\\_TransmiT\\_Connections\\_Consultation\\_FINAL.pdf](http://www.Ofgem.gov.uk/NETWORKS/TRANS/PT/Documents1/110322_TransmiT_Connections_Consultation_FINAL.pdf)
- ———. 2011b. "Project TransmiT: Publication of the Draft Academic Reports on Charging Models and Next Steps." Reference no. 39/11. London: OFGEM, March. [http://www.Ofgem.gov.uk/NETWORKS/TRANS/PT/Documents1/110322\\_TransmiT\\_Charging\\_Update%20for%20publication.pdf](http://www.Ofgem.gov.uk/NETWORKS/TRANS/PT/Documents1/110322_TransmiT_Charging_Update%20for%20publication.pdf)
- Pérez-Arriaga, I. J. N.d. *Engineering, Economics and Regulation of the Electric Power Sector*. Retrieved 4/15/ 2011 from MIT Open Coursework. [http://ocw.mit.edu/courses/engineering-systems-division/esd-934-engineering-economics-and-regulation-of-the-electric-power-sector-spring-2010/lecture-notes/MITESD\\_934S10\\_lec\\_16.pdf](http://ocw.mit.edu/courses/engineering-systems-division/esd-934-engineering-economics-and-regulation-of-the-electric-power-sector-spring-2010/lecture-notes/MITESD_934S10_lec_16.pdf)
- PJM Interconnection. 2010. "A Survey of Transmission Cost Allocation Issues, Methods and Practices." Norristown, Pennsylvania: PJM Interconnection, March 10. <http://ftp.pjm.com/~media/documents/reports/20100310-transmission-allocation-cost-web.ashx>
- PUC (Public Utility Commission of Texas). 2009a. Chapter 25. Substantive Rules Applicable to Electric Service Providers. Subchapter H. Electrical Planning. Division 1: Renewable Energy Resources and Use of Natural Gas. Austin, Texas. November. <http://www.puc.state.tx.us/rules/subrules/electric/25.174/25.174.pdf>
- ———. 2009b. "Final Order, Docket No. 35665, at Finding of Fact 28." Austin, Texas, March 30.
- PUCT-CREZ (Public Utility Commission of Texas—CREZ Transmission Program Information Center). 2010. *Public Utility Commission of Texas—CREZ*. Retrieved May 15, 2011, from the Public Utility Commission of Texas—CREZ. <http://www.texascrezprojects.com/default.aspx>
- PUC—Texas. (2010). *PUC—Texas—CREZ Transmission Program Information Center*. Retrieved 05 15, 2011, from Program Overview: <http://www.texascrezprojects.com/overview.aspx>
- PUR (Public Utilities Reports, Inc.). *PUR GUIDE—Training Manual on Public Utilities Operations and*

Management. Vienna, VA: Public Utilities Reports, Inc. <http://www.pur.com/books/12.cfm>

- Red Eléctrica de España. 2011. "Grid Planning and Development." Madrid: Red Eléctrica de España. [http://www.ree.es/ingles/transporte/planificacion\\_desarrollo\\_red\\_transporte.asp](http://www.ree.es/ingles/transporte/planificacion_desarrollo_red_transporte.asp)
- ———. 2010. *The Spanish Electricity System.* Madrid: Red Eléctrica de España. [http://www.ree.es/ingles/sistema\\_electrico/informeSEE.asp](http://www.ree.es/ingles/sistema_electrico/informeSEE.asp)
- REN21. 2010. *Renewables 2010 Global Status Report.* Paris: REN21 Secretariat. <http://www.ren21.net/REN21Activities/Publications/GlobalStatusReport/tabid/5434/Default.aspx>.
- Republic of the Philippines—Department of Energy. 2009. "Rules and Regulations Implementing Republic Act No. 9513." Department Circular No. DC2009-05-0008. Manila, May.
- RS&H. 2011. *CREZ Progress Report No.2.* Austin, Texas: Public Utility Commission of Texas.
- Scott, N. C. 2007. *European Practices with Grid Connection, Reinforcement, Constraint and Charging of Renewable Energy Projects.* Glasgow: Xero Energy Ltd. August 1. [http://www.ontario-sea.org/Storage/28/1978\\_EU-practices-grid-connection\\_2007.pdf](http://www.ontario-sea.org/Storage/28/1978_EU-practices-grid-connection_2007.pdf)
- SECO (State Energy Conservation Office). 2011. *Texas Renewable Portfolio Standard.* Austin, TX: SECO. Retrieved April 15. [http://www.seco.cpa.state.tx.us/re\\_rps-portfolio.htm](http://www.seco.cpa.state.tx.us/re_rps-portfolio.htm)
- ———. 2011. "Texas Wind Transmission Constraints." Austin, TX: SECO. [http://www.seco.cpa.state.tx.us/re\\_wind-transmission.htm](http://www.seco.cpa.state.tx.us/re_wind-transmission.htm)
- Secretaría de Energía. 2010. "Estrategia Nacional de Energía ratificada por el H. Congreso de la Unión." Mexico, D.F.: Secretaría de Energía, September 8. <http://www.energia.gob.mx/res/1646/EstrategiaNacionaldeEnergiaRatificadaaporelHCongresodelaUnion.pdf>.
- SOU (Statens Offentliga Utredningar). 2008. "Grid Issues for Electricity Production Based on Renewable Energy Sources in Spain, Portugal, Germany, and United Kingdom. Annex to Report of the Grid Connection Inquiry." SOU 2008:13. Stockholm: Statens Offentliga Utredningar. <http://www.sweden.gov.se/content/1/c6/09/85/14/4c8fba69.pdf>
- SPP (Southwest Power Pool). 2010. "FERC Approves New Cost Sharing Method for Expanding SPP's Transmission Grid 6/17/2010." Press release. Little Rock, Arkansas: SPP. <http://www.spp.org/section.asp?pageID=18>
- Stoff, Steven, Carrie Webber, and Ryan Wiser. 1997. "Transmission Pricing and Renewables: Issues, Options, and Recommendations." Environmental Energy Technologies Division, Ernest Orlando Lawrence Berkeley National Laboratory, University of California, Berkeley, California. <http://eetd.lbl.gov/ea/emp/reports/39845.pdf>
- TenneT. 2010a. "Dena Grid Study." October 1. Bayreuth, Germany: TenneT TSO GmbH. [http://www.tennetso.de/pages/tennetso\\_en/EEG\\_KWK-G/Renewable\\_Energy\\_Source\\_Act/Wind\\_Power\\_On\\_and\\_Offshore/dena\\_grid\\_study/index.htm](http://www.tennetso.de/pages/tennetso_en/EEG_KWK-G/Renewable_Energy_Source_Act/Wind_Power_On_and_Offshore/dena_grid_study/index.htm)
- ———. 2010b. "Minimum Technical Requirements for Connections to the Grid." October 1. Bayreuth, Germany: TenneT TSO GmbH. [http://www.tennetso.de/pages/tennetso\\_en/Transparency/Publications/Grid\\_connection/Grid\\_connection\\_regulations/index.htm](http://www.tennetso.de/pages/tennetso_en/Transparency/Publications/Grid_connection/Grid_connection_regulations/index.htm)
- Texas PUC (Public Utility Commission of Texas). 1999, "Substantive Rules." Chapter 25. Electric. December 6. [www.puc.state.tx.us/rules/subrules/electric/25.192/21080adt.doc](http://www.puc.state.tx.us/rules/subrules/electric/25.192/21080adt.doc)
- U.K. Department of Energy and Climate Change. 2009. *Digest of United Kingdom Energy Statistics: Energy Trends.* London: TSO.
- U.S. DOE (U.S. Department of Energy). 2008. *20% Wind Energy by 2030: Increasing Wind Energy's Contribution to U.S. Electricity Supply.* Washington, D.C.: U.S. Department of Energy.
- ———. 2010a. "2009 Wind Technologies Market Report." U.S. Department of Energy.
- ———. 2010b. "2016 Levelized Cost of New Generation Resources from the Annual Energy Outlook 2010." U.S. Department of Energy.

- U.S. DOE/NETL. 2007. *Cost and Performance Baseline for Fossil Energy Plants Desk Reference*. Washington, D.C.: U.S. Department of Energy/National Energy Technology Laboratory. <http://www.netl.doe.gov/energy-analyses/pubs/deskreference/>
- U.S. EIA (Energy Information Administration). 2010. "Electricity Demand." Report no. DOE/EIA-0383(2010). Washington, D.C.: U.S. EIA/U.S. DOE. <http://www.eia.doe.gov/oiaf/archive/aeo10/electricity.html>
- Van der Weijde, A. H., and B. F. Hobbs. 2011. "Planning Electricity Transmission to Accommodate Renewables: Using Two-Stage Programming to Evaluate Flexibility and the Cost of Disregarding Uncertainty." EPRG Working Paper 1102, Cambridge Working Paper in Economics 1113.
- Wilks, Mike, and Simor Bradbury. 2010. *Electricity Transmission Use of System Charging: Theory and International Experience—A Report to EDF Energy*. Oxford: Pöry Energy Ltd. [http://www.Ofgem.gov.uk/Networks/Trans/PT/WF/Documents1/Tx\\_Charging\\_Theory\\_and\\_Practice\\_P%C3%B6ry\\_Energy%20pdf.pdf](http://www.Ofgem.gov.uk/Networks/Trans/PT/WF/Documents1/Tx_Charging_Theory_and_Practice_P%C3%B6ry_Energy%20pdf.pdf)
- Woodfin. 2007. "Texas Competitive Renewable Energy Zones (CREZ)." Presentation by Dan Woodfin—Director, System Planning. [http://old.nationalwind.org/pdf/Woodfin\\_NWCC\\_CREZ\\_20070822.pdf](http://old.nationalwind.org/pdf/Woodfin_NWCC_CREZ_20070822.pdf)
- World Bank. 2010a. "Design and Performance of Policy Instruments to Promote the Development of Renewable Energy: Emerging Experience in Selected Developing Countries." Final Report, Energy Anchor Unit-Sustainable Energy Department, World Bank, Washington, D.C.
- ———. 2010b. *Planning Transmission for Renewable Energy: Methodological Elements for Planning and Cost Recovery in the Philippines*. Final Report, June 2010, VERSION 2.0. Washington, D.C.: World Bank.
- ———. 2010c. "Technical Expansion and Cost Recovery Options for Transmission Expansion for Renewable Energy in the Philippines." World Bank, PSR, slides, March.
- XM Colombia. 2009. "Transmission Expansion and Pricing in Colombia: An Appraisal of Current Practices." Presentation by XM and Universidad Tecnológica de Pereira, Colombia. <http://www.ieee.org/organizations/pes/meetings/gm2009/slides/pesgm2009p-001153.pdf>







THE WORLD BANK  
GROUP



The Energy and  
Mining Sector Board

The World Bank  
1818 H Street N.W.  
Washington, D.C. 20433  
USA