

# Options for a low carbon energy future in Morocco

## Final Report

Revision 2

Ref. BF 2083015



Prepared for:



**World Bank**



November 2009

**BeicipFranlab** 

232, av. Napoléon Bonaparte – BP 213  
92502 Rueil-Malmaison Cedex – France  
Tel: +33 1 47 08 80 00 - Fax: +33 1 47 08 41 85  
e-mail: info@beicip.com – www.beicip.com

## Disclaimer

This document was prepared by Beicip-Franlab for the sole use of its customer under a specific contract and is submitted on the basis of the confidentiality clause under such contract. Any information given to Beicip-Franlab by its customer was used for performance of this work, only.

Beicip-Franlab has made its best efforts in preparing this document according to industrial practices into force. All the results are based on the information provided by the customer and known at the time when work was carried out.

<b>Beicip-Franlab Project Number</b>	<b>2083015</b>
<b>Client Contract Number</b>	
<b>Date</b>	<b>November 2009</b>

<b>Prepared by:</b>		
<b>Name</b>	<b>Position</b>	<b>Signature</b>
<b>R.GALEAZZI</b>	<b>Head of Downstream Unit Oil and Gas Consultancy</b>	

<b>Checked by:</b>		
<b>Name</b>	<b>Position</b>	<b>Signature</b>
<b>Y.BOURG</b>	<b>Director</b>	

<b>Approved by:</b>		
<b>Name</b>	<b>Position</b>	<b>Signature</b>
<b>Y.BOURG</b>	<b>Director</b>	

**Beicip-Franlab**  
 232 Av. Napoléon Bonaparte  
 92500 Reuil Malmaison  
 France  
 Phone: 33 1 47 08 81 79  
 Fax: 33 1 47 08 81 45  
 Email: [renaud.galeazzi@beicip.com](mailto:renaud.galeazzi@beicip.com)

## Table of Contents

<b>1</b>	<b>INTRODUCTION .....</b>	<b>7</b>
<b>2</b>	<b>WORLD ENERGY OUTLOOK .....</b>	<b>8</b>
2.1	Kyoto Protocol.....	8
2.2	IEA 2008 scenarios for 2030.....	9
<b>3</b>	<b>ENERGY BALANCE OF MOROCCO .....</b>	<b>11</b>
3.1	Overall energy balance .....	11
3.2	Energy supply .....	12
3.2.1	Quantity.....	12
3.2.2	Energy bill.....	14
3.3	Energy transformation.....	16
3.3.1	Refinery.....	16
3.3.2	Power .....	17
3.4	Final consumption.....	21
3.4.1	Agriculture .....	22
3.4.2	Industry.....	22
3.4.3	Transport.....	23
3.4.4	Residential & commercial .....	23
3.5	CO2 emissions from fuel combustion.....	24
3.6	CO2 from fuel combustion and greenhouse gases .....	25
3.7	CO2 emissions benchmarking .....	26
<b>4</b>	<b>MOROCCO STRATEGY FOR 2030.....</b>	<b>27</b>
4.1	Targets of the Morocco strategy .....	27
4.1.1	Renewable energy.....	29
4.1.2	Nuclear .....	42
4.1.3	Gas.....	43
4.1.4	Petroleum products.....	44
4.1.5	Coal .....	45
4.1.6	Energy efficiency .....	47
4.2	Evaluation of Morocco strategy .....	48
4.2.1	Criteria of evaluation.....	48
4.2.2	Definition of indicators for each criterion.....	48
4.2.3	Results of the evaluation of Morocco strategy.....	53
4.2.4	Cost of CO2 abatement.....	56
4.3	Measures taken by Morocco to reach the targets .....	57
<b>5</b>	<b>PROPOSED HIGH EE&amp;RE SCENARIO TO STABILISE MOROCCO ENERGY CO2 EMISSIONS.....</b>	<b>59</b>
5.1	Targets of the scenario .....	59
5.2	Potential measures to reach these targets.....	59
5.2.1	Renewable energy.....	59

5.2.2	<i>Nuclear</i> .....	66
5.2.3	<i>Gas</i> .....	66
5.2.4	<i>Petroleum products</i> .....	67
5.2.5	<i>Coal</i> .....	67
5.2.6	<i>Energy efficiency</i> .....	69
5.3	Deep electrification of Morocco .....	71
5.4	Evaluation of the high EE&RE scenario .....	73
5.5	Comparison of the two low carbon energy scenarios .....	78
5.6	Solar plan of November 2009 .....	80
<b>6</b>	<b>RENEWABLE ENERGY EXPORT POTENTIAL TO EUROPE</b> .....	<b>81</b>
6.1	Europe targets and present interconnection .....	81
6.2	Europe power sector present and future emissions .....	83
6.3	Spain current interconnections and exchange prices .....	84
<b>7</b>	<b>CONCLUSION</b> .....	<b>86</b>
	<b>REFERENCES</b> .....	<b>87</b>

## List of Tables

Table 1 Morocco energy balance – 2006.....	11
Table 2 Share of RE for power in TPES .....	13
Table 3 Morocco power balance .....	17
Table 4 CO2 emissions from fuel combustion balance .....	24
Table 5 Morocco greenhouse gas emissions.....	25
Table 6 Morocco net greenhouse gas emissions for forestry.....	25
Table 7 CO2 emissions benchmarking .....	26
Table 8 Morocco energy strategy: TPES projection without EE.....	27
Table 9 Morocco energy strategy: TPES projection with EE.....	28
Table 10 Morocco petroleum products consumption .....	44
Table 11 Split of the Moroccan target of energy efficiency .....	47
Table 12 Value of the energy sustainable development indicator .....	48
Table 13 Value of the import dependency indicator .....	48
Table 14 Average energy FOB price ratio to Brent (2004 - 2008).....	49
Table 15 CIF prices (\$/toe) for two levels of Brent price (60 \$/bbl & 100 \$/bbl) .....	50
Table 16 LCOE for the different power plant technologies.....	50
Table 17 CO2 emission intensity of the different types of energy .....	52
Table 18 Characteristics of the BAU scenario.....	52
Table 19 Results of the evaluation of the BAU scenario .....	53
Table 20 Results of the evaluation of the Moroccan strategy .....	53
Table 21 Morocco development strategy: CO2 abatement.....	54
Table 22 List of 35 dams able to support pumping storage plant (PSP) .....	61
Table 23 Breakeven power emission intensity .....	71
Table 24 Results of the evaluation of the high EE and RE scenario.....	73
Table 25 High EE and RE scenario: CO2 abatement .....	74
Table 26 Balance of the High EE and RE scenario.....	77
Table 27 Solar plan power plants.....	80
Table 28 Renewable energy in 2020 with November 2009 solar plan .....	80
Table 29 Europe power sector in comparison with Morocco.....	83
Table 30 Power exchange between France and Spain in 2008.....	84

## List of Figures

Figure 2-1 World energy consumption .....	9
Figure 2-2 IEA fossil energy price .....	10
Figure 3-1 Morocco total primary energy supply (TPES) .....	12
Figure 3-2 Morocco 2006: energy bill.....	14
Figure 3-3 Morocco 2006: energies CIF price (\$/toe) .....	14
Figure 3-4 Spatial and temporal distribution of rainfall (mm) in Morocco .....	18
Figure 3-5 Morocco power importation .....	19
Figure 3-6 ONE power peak demand - 2008 .....	19
Figure 3-7 ONE power peak demand - 2007 .....	20
Figure 3-8 Final energy consumption of Morocco .....	21
Figure 3-9 Final energy consumption – industry sector .....	22
Figure 3-10 Final energy consumption – transport sector.....	23
Figure 3-11 Final energy consumption – residential and commercial .....	23
Figure 3-12 CO2 emission from fossil combustion.....	24
Figure 4-1 Morocco wind energy potential .....	30
Figure 4-2 Morocco population density - 2004.....	31
Figure 4-3 Potential of implantation of wind turbines in Morocco .....	32
Figure 4-4 Tarfaya: wind direction frequency.....	33
Figure 4-5 Tarfaya: daily wind speed (@20m).....	34
Figure 4-6 Tarfaya: duration of calms of the wind (@20m).....	35
Figure 4-7 Tarfaya: annually wind speed (@20m) .....	36
Figure 4-8 Tarfaya: wind turbine power curve.....	36
Figure 4-9 Morocco solar potential.....	38
Figure 4-10 Ain Beni Mathar ISGC plant scheme .....	39
Figure 4-11 Morocco petroleum products consumption.....	44
Figure 4-12 Power generation: equilibrium prices (natural gas vs coal).....	45
Figure 4-13 Power generation: LCOE comparison .....	46
Figure 4-14 LCOE breakdown per power generation technology (Brent @60\$/bbl) .....	51
Figure 4-15 LCOE breakdown per power generation technology (Brent @100\$/bbl) .....	51
Figure 4-16 Morocco development strategy evaluation .....	53
Figure 4-17 Morocco development strategy: abatement curve .....	54
Figure 4-18 Morocco development strategy: CO2 abatement cost.....	56
Figure 4-19 Morocco power plants equipment plan (2009-2015).....	57
Figure 4-20 Morocco power transport and distribution network .....	58
Figure 5-1 Example of wind power production and power system load .....	60
Figure 5-2 Bird's-eye view of a seawater PSP in Okinawa (Japan) .....	62
Figure 5-3 Bird's-eye view of La Muela PSP (Spain) .....	63
Figure 5-4 High EE and RE scenario: wind power penetration .....	64
Figure 5-5 Andasol 1 plant scheme (CSP with storage) .....	65
Figure 5-6 Biomass and coal co-firing power plant .....	66
Figure 5-7 CO2 emissions of Moroccan coal power plants.....	67
Figure 5-8 Power plant technologies part load efficiency.....	68
Figure 5-9 Toyota Prius and Peugeot 30x CO2 emissions evolution .....	69
Figure 5-10 Picture of the bus rapid transit of Bogota.....	70
Figure 5-11 Comparison of the emission intensity of electricity production.....	71
Figure 5-12 Evaluation of the high EE and RE scenario .....	73
Figure 5-13 High EE and RE scenario: CO2 abatement curve .....	74
Figure 5-14 High EE and RE scenario: CO2 abatement cost .....	76
Figure 5-15 Comparison of Moroccan strategy with High EE&RE scenario.....	78
Figure 5-16 Net cost of low carbon energy scenarios compared to BAU (Brent@60\$/bbl).....	79
Figure 5-17 Net cost of low carbon energy scenarios compared to BAU (Brent@100\$/bbl).....	79
Figure 6-1 Exporting renewable energy to Europe.....	81
Figure 6-2 ENTSOE present interconnection (2008 figures in GWh).....	82
Figure 6-3 Evolution of Spain power interconnections (2004-2008).....	84

## 1 INTRODUCTION

Morocco's economy is growing rapidly in all its sectors (tourism, agriculture, industry ...). Consequently, the energy demand has been increasing steadily in the period 2003-2007 when primary energy demand rose by 5% per annum and electricity demand by 8% per annum.

At the request of the World Bank Group, this study was launched having 3 main objectives:

- an analysis of the current characteristics of energy supply and demand,
- the assessment of the energy strategy of Morocco for the coming years,
- then a development of an alternative energy scenario with low carbon energies.

Beicip-Franlab has established a detailed energy balance of Morocco on the basis of Moroccan and international studies already conducted on the energy sector of Morocco as well as on well known databases like IEA ones.

For the period 2009-2030, Morocco has defined an energy strategy which was presented during the first "Assises de l'Energie" organized in March 2009. An assessment of this strategy considering both energy and environmental criteria will be presented in order to be compared with the business as usual scenario.

Finally an alternative scenario is proposed. Based on an intensive introduction of renewable energy (RE) and energy efficiency (EE), this scenario would permit a great exploitation of the available RE potential in Morocco, and particularly its wind power potential.

In November 2009 after the present report is finalized, Moroccan authorities presented a solar power plan which increases its renewable energy target in 2020, making solar energy target comparable to its wind energy target.

A quick review of this new solar plan is presented at the end of this report.

## 2 WORLD ENERGY OUTLOOK

### 2.1 Kyoto Protocol

The Kyoto Protocol is an international agreement between 182 Parties of the United Nations Framework Convention on Climate Change (UNFCCC). It was adopted in December 1997 and entered into force on 16<sup>th</sup> February 2005.

The main goal of this protocol is to push industrialized countries to reduce, during the period 2008-2012, their greenhouse gas (GHG) emissions by at least 5% from their emissions level in 1990. Thirty seven industrialized countries and the European Union are concerned.

There is no specific target for developing countries as Morocco.

The basic idea of the Kyoto Protocol is to reduce GHG global emissions by the cheapest way.

For that, three flexible tools were defined:

- Emissions Trading: greenhouse gas emissions become a new commodity that countries from Annex 1 can exchange.
- Joint Implementation: this tool allows to countries from Annex 1 to earn emission reduction credits by financing projects that reduce GHG emissions in another Annex 1 country.
- Clean Development Mechanism: similar to the Joint Implementation except that the host country of the project has to be a developing country.

This protocol is the first step to stabilize GHG emissions and to prevent global warming and climate changes.

The next step will be the conference to be held in Copenhagen in December 2009 where a new global climate-change policy regime regarding the reduction of GHG emissions will be defined for beyond 2012 (the final year of coverage of the first commitment period of the Kyoto Protocol).



## 2.2 IEA 2008 scenarios for 2030

In its World Energy Outlook 2008, the International Energy Agency (IEA) presented three scenarios of development:

- The Reference Scenario is a business as usual scenario. In this scenario CO<sub>2</sub> emissions from fossil fuel are increasing by 45%. The overall effect on climate change is up to 6°C. The equilibrium price of the Brent is 122 \$/bbl in constant dollar.
- The 550ppm Policy Scenario which corresponds to the concentration of greenhouse gases as equivalent CO<sub>2</sub> in the atmosphere. This scenario allows mitigating the temperature increase to 3°C. It is also the most economical scenario as the investments to reach this target are paid by a lower equilibrium price of the Brent at 100\$/bbl.
- A third scenario is envisaged to target a 450ppm CO<sub>2</sub> equivalent concentration. This scenario is considered less economic by IEA as CO<sub>2</sub> abatement measures are not paid by the decrease of price of the fossil fuels. Despite the fact of being less economical, this scenario might be pushed by political measures in order to achieve the mitigation of the temperature increase to 2°C.

Here after are presented the historical trend, and the two extreme scenarios for 2030, the Reference Scenario and the 450ppm Policy Scenario.

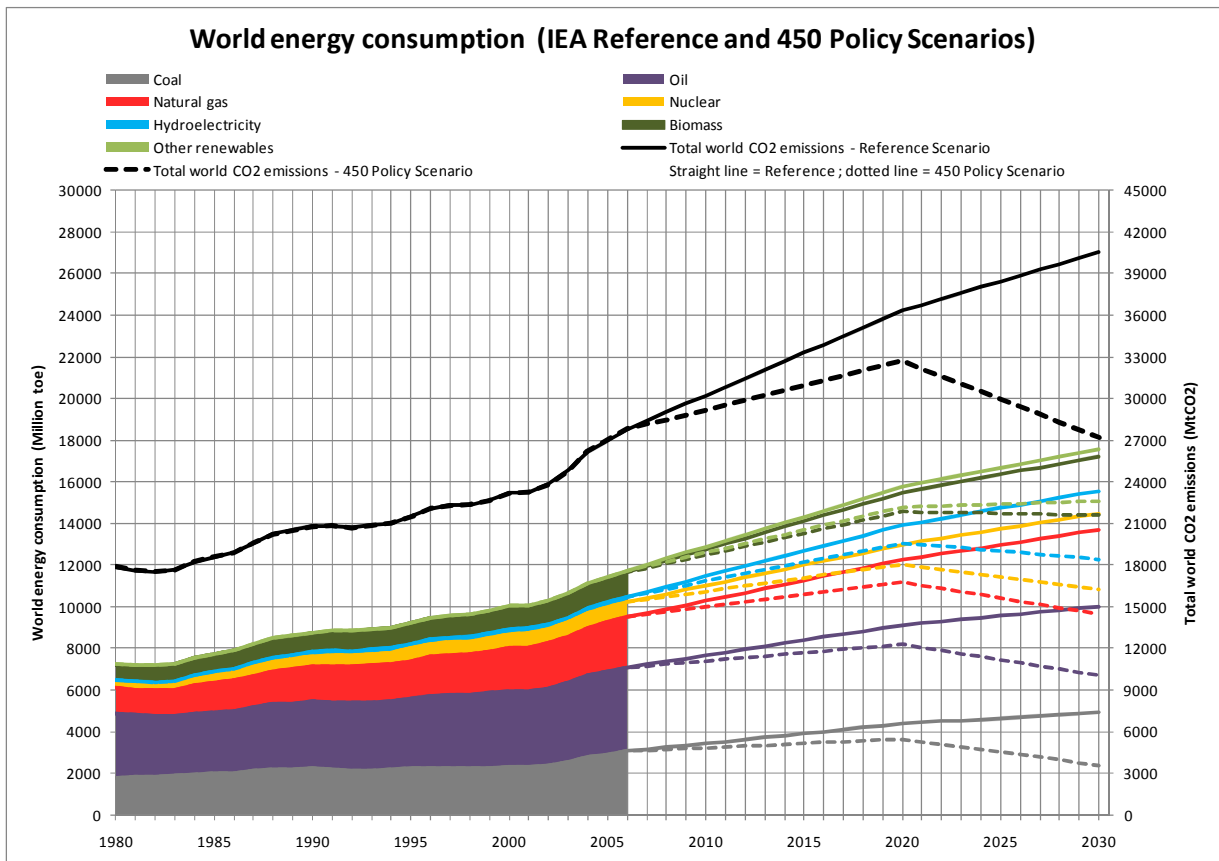

Source: IEA

Figure 2-1 World energy consumption

The 450ppm Policy Scenario can be considered as a sustainable one for the CO<sub>2</sub> emissions. The overall energy demand is stabilized and fossil fuels demand is decreasing. The fossil fuels consumption is reduced back to 2006 level but reserves depleting issue remains on the long term requiring additional efforts after 2030.

For the developed countries the 450 Policy Scenario implies the abatement of their CO<sub>2</sub> emissions from fuel combustion by 40% while it should not be more than 20% of increasing for the developing countries.

IEA forecasts lower prices for fossil fuels in the Policy Scenarios 550 and 450 (PS 550 and 450) where their demands are significantly less than in the Reference Scenario. The graph hereafter gives price forecast used by IEA for the different scenarios.

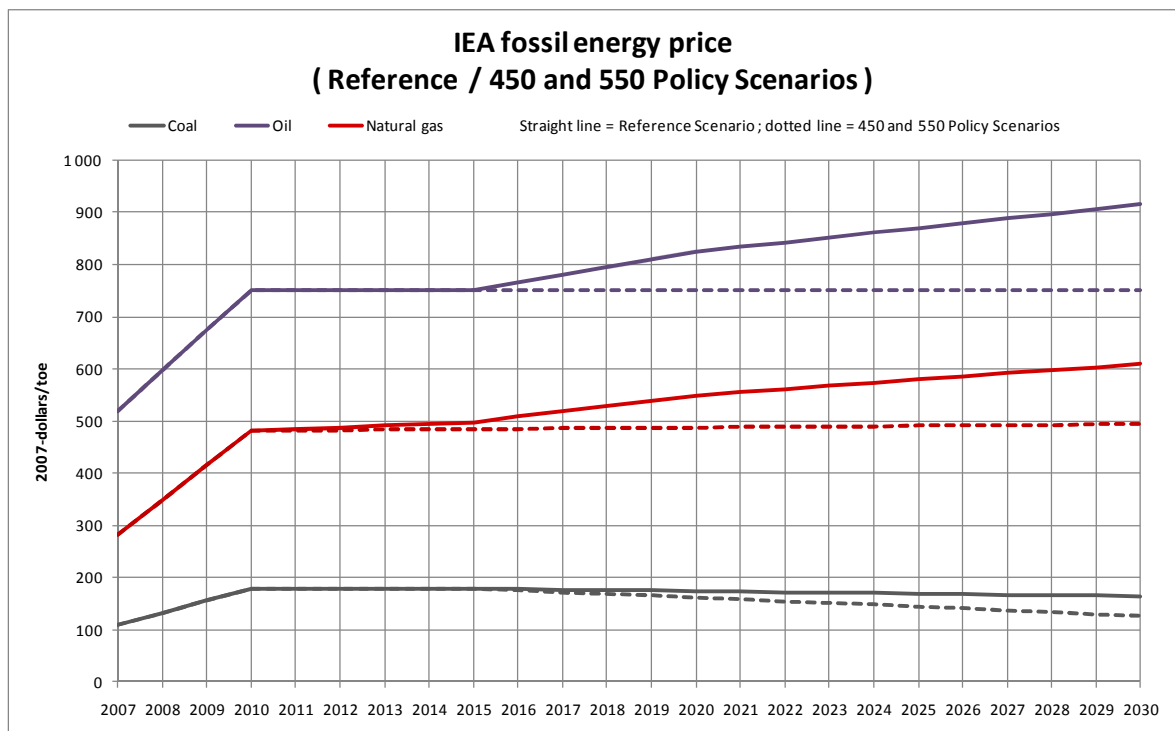

Source: IEA

**Figure 2-2 IEA fossil energy price**

In the PS 550 and 450, prices of oil and gas are stabilized. Price of coal is slightly decreased in the Reference Scenario pushed by carbon tax of 90\$/tCO<sub>2</sub> considered by IEA as of 2030. This decrease is more important with PS 550 and 450 as coal is the fossil fuel which demand decreases sharply due to its CO<sub>2</sub> emission intensity and the technical possibility to replace it by renewable energy in the power production.

### 3 ENERGY BALANCE OF MOROCCO

#### 3.1 Overall energy balance

Overall energy balance is given hereafter based on ENERDATA , IEA and Ministère de l'Énergie, des Mines de l'Eau et de l'Environnement of Morocco (MEMEE) data.

Morocco was consuming 13.4 Mtoe/y as primary energy in 2006.

Only 5% of the primary energy supply is produced by Morocco mainly from biomass.

For the transformation sector, refineries consume 2% of this primary energy supply and power plants consume 23% including grids and pumped storage plants (PSP) losses.

The final consumption accounted for 75% of primary consumption.

**Table 1 Morocco energy balance – 2006**

Year 2006	Unit	Coal	Oil	Fuel	GT fuel	Gasoil	Jet	Gasoline	Naphtha	LPG	Pet. Prod.	Gas	Tot. fos.	Hydro	PSP	Wind	Bio-mass	Int. power	Imp. power	Total	Share per sector
<b>Morocco energy balance</b>																					
Production	Mtoe		0.01									0.06	0.07	0.08		0.02	0.45			0.61	5%
Imports	Mtoe	3.74	6.17			1.75				1.50	3.25	0.43	13.59						0.17	13.76	103%
Exports	Mtoe			-0.60					-0.51		-1.11		-1.11							-1.11	-8%
Bunker	Mtoe			-0.01							-0.01		-0.01							-0.01	0%
Stock change	Mtoe		0.20			-0.04					-0.04		0.16							0.16	1%
<b>Total primary energy supply</b>	<b>Mtoe</b>	<b>3.74</b>	<b>6.38</b>	<b>-0.61</b>	<b>0.00</b>	<b>1.71</b>	<b>0.00</b>	<b>0.00</b>	<b>-0.51</b>	<b>1.50</b>	<b>2.09</b>	<b>0.49</b>	<b>12.70</b>	<b>0.08</b>	<b>0.00</b>	<b>0.02</b>	<b>0.45</b>	<b>0.00</b>	<b>0.17</b>	<b>13.42</b>	<b>100%</b>
Primary energy share		28%	48%	-5%	0.0%	13%	0%	0%	-4%	11%	16%	3.7%	95%	0.6%	0.0%	0.1%	3%	0.0%	1.3%	100%	
Refineries	Mtoe		-6.38	1.99	0.16	2.04	0.40	0.37	0.51	0.35	6.11		-0.27						1.69	-0.27	2%
Power plants	Mtoe	-3.27		-0.60	-0.16						-0.76	-0.43	-4.46	-0.08	-0.06	-0.02		1.69		-2.93	22%
Pumping storage plant(PSP)	Mtoe														0.05			-0.05		0.00	0%
Power losses	Mtoe														0.01			-0.15		-0.14	1%
Imported power	Mtoe																	0.17	-0.17	0.00	0%
<b>Total final consumption</b>	<b>Mtoe</b>	<b>0.47</b>	<b>0.00</b>	<b>0.78</b>	<b>0.00</b>	<b>3.75</b>	<b>0.40</b>	<b>0.37</b>	<b>0.00</b>	<b>1.85</b>	<b>7.44</b>	<b>0.06</b>	<b>7.97</b>	<b>0.00</b>	<b>0.00</b>	<b>0.00</b>	<b>0.45</b>	<b>1.66</b>	<b>0.00</b>	<b>10.08</b>	<b>75%</b>
Agriculture	Mtoe					0.81				0.40	1.21		1.21					0.18		1.39	10%
Industry	Mtoe	0.47		0.78		0.22				0.10	1.10	0.06	1.63				0.07	0.77		2.47	18%
Transport	Mtoe					2.69	0.40	0.37			3.46		3.46					0.02		3.48	26%
Residential & commercial	Mtoe					0.03				1.35	1.38		1.38				0.38	0.69		2.45	18%
Other (non energy)	Mtoe										0.29		0.29							0.29	2%

Source: ENERDATA, IEA, MEMEE, Beicip-Franlab

**Note:** 1 TWh=0.086 Mtoe for hydro, wind and imported power.

## 3.2 Energy supply

### 3.2.1 Quantity

The split of the energy supply is as follows:

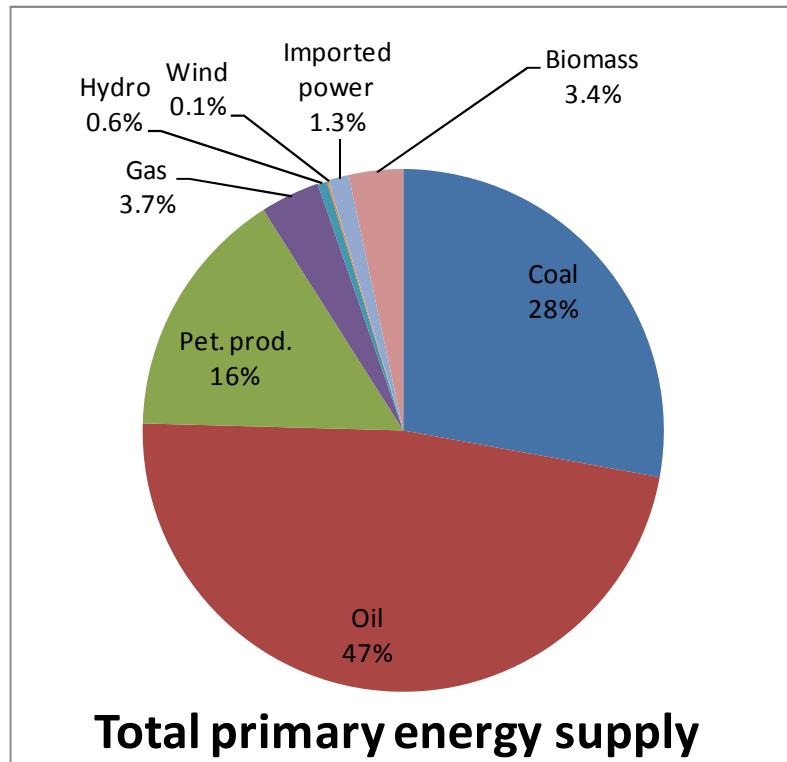

Source: ENERDATA, IEA, MEMEE, Beicip-Franlab

**Figure 3-1 Morocco total primary energy supply (TPES)**

Oil and petroleum products are dominant with 63% of the total - 47% is processed in the refinery and 16% is imported as finished products. Coal represents a high share in the primary energy mix accounting for 28% of the total supply. Coal share was only 8% in 1980, since then it has been the main fuel to supply new power requirement.

Gas share is small (3.7%) and limited to the transport fee paid by Algeria to export gas to Spain with the GME pipeline crossing the north of Morocco.

Hydro share is small due to very low capacity factor of Morocco dams being around 8% while wind power is emerging in the energy mix of Morocco since year 2000.

It should be mentioned that for MEMEE, the adopted convention for hydro, wind and solar producing power is 1 TWh=0.260 Mtoe meaning an equivalent electrical yield of 33% from fossil fuel. This convention is also used for imported power and future nuclear plant.

This convention allows an easy evaluation of MEMEE strategy at equivalent TPES when switching fossil fuel usage to renewable energy for power production.

The following table gives the share of RE for power in TPES according to the different conventions.

**Table 2 Share of RE for power in TPES**

year	MEMEE	IEA
2006	2.2%	0.7%
2030 Morocco target	15.0%	5.6%
2030 High RE scenario	30.0%	12.5%

This MEMEE convention will be used for the evaluation of Morocco strategy, however RE share in power production will be calculated on power produced and the result is the same for the two conventions.

Biomass is not accounted by MEMEE in its TPES, the figure of 0.45 Mtoe/y is given by MEMEE to IEA with some corrections of poor yield obtained by burning this biomass.

The quantity of biomass used in Morocco for firing is around 11 Mt/y as per module 5 “changements d'exploitation des sols et gestion des forêts” of MEMEE. With an estimated humidity of 40% and a heating value of 0.37 toe per ton of dry biomass, the resulting amount in the TPES should have been 2.44 Mtoe/y meaning a share of 16% of the TPES.

As sustainable usage of biomass is considered as a renewable energy by Morocco strategy and will contribute to the decrease of CO<sub>2</sub> emissions. Therefore, the accounting methodology of biomass should be clarified.

### 3.2.2 Energy bill

The configuration of the TPES is different if we split the Morocco total energy bill of 5.1G\$ for importation in 2006 (Brent at 64\$/b and 1\$=8.7 MDH) by products.

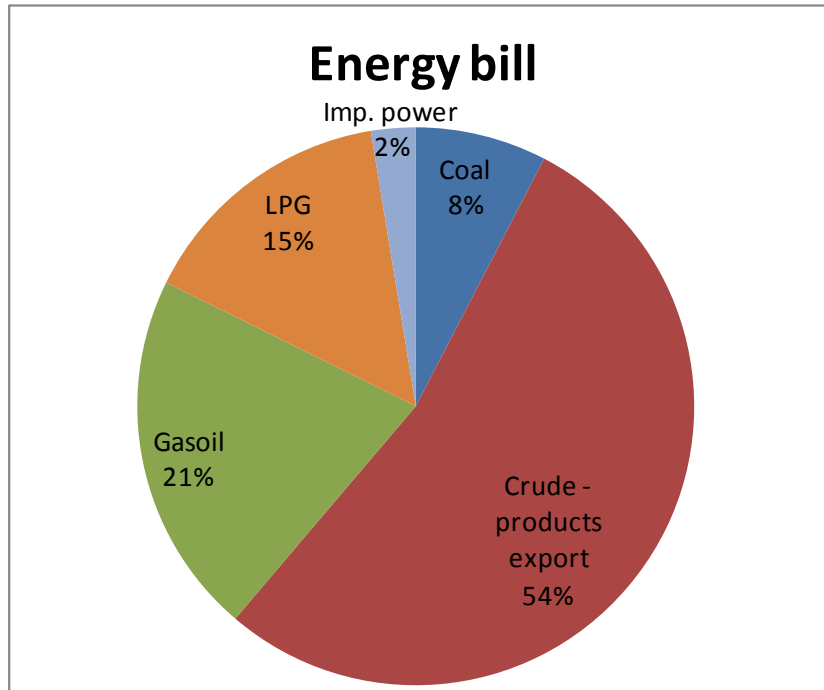

Source: MEMEE, Beicip-Franlab

**Figure 3-2 Morocco 2006: energy bill**

90% of the energy bill is coming from crude oil and petroleum products with 21% for gasoil and a very important share of 15% for LPG which is mainly butane. On the other hand coal accounts for only 8% of the energy bill whereas it was 28% of the TPES. This is explained by the low cost of coal compared to other products as shown in the following graph:

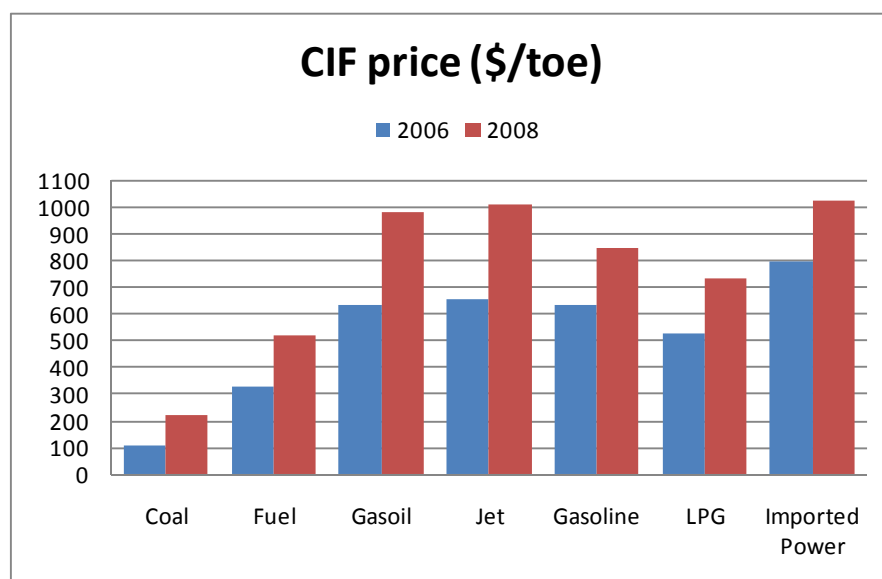

Source: MEMEE, Platts Oilgram Price Report

**Figure 3-3 Morocco 2006: energies CIF price (\$/toe)**

The relative low cost of coal even during the high energy price period of 2008 explains most of its popularity; the other advantages are the availability as well as the short term contract commitment.

The high energy price environment of the last two years shows the same competitive advantage for coal and in IEA projection for 2030 as well. Coal will remain an economical choice for countries with no CO<sub>2</sub> emissions constraints.

### 3.3 Energy transformation

#### 3.3.1 Refinery

Morocco has one refinery of a nameplate capacity of 6 Mt/y with a simple scheme (hydroskimming). In 2009, a hydrocracking unit and a new diesel desulphurization unit will be started at this refinery allowing producing 50 ppm sulphur contained diesel and decreasing the deficit of gasoil produced by the refinery making it more appropriate for the market need. The refinery energy transformation cost is 2% of the overall balance or 4 % of the oil processed. With the addition of the new units this consumption should be doubled.

On the other hand the new units will improve the refining margin from no margin as today to a margin around 8% of crude price. This margin is consequent gain on the energy bill of Morocco on a long term basis.

On top of that this present scheme should be able to easily produce 10 ppm sulphur contained gasoil, which will allow Morocco to use Euro 5 trucks and cars and subsequently it can significantly decrease air pollution from NOx and particulates. The new diesel engines which require Euro 5 are much more fuel efficient, this will help Morocco to reach its energy efficiency target for transportation.



### 3.3.2 Power

The power production sector is composed of thermal power plant, hydro power plant and wind farms as shown hereafter.

**Table 3 Morocco power balance**

Power		Coal	Fuel	GT fuel	Pet. prod.	Gas	Tot. fos.	Hydro	PSP	Wind	Int. power	Imp. power	Total
<b>Power plants production</b>	<b>TWh</b>	<b>12.90</b>	<b>2.13</b>	<b>0.47</b>	<b>2.60</b>	<b>2.51</b>	<b>18.01</b>	<b>0.90</b>	<b>0.60</b>	<b>0.18</b>	<b>19.67</b>	<b>1.98</b>	<b>21.65</b>
Power production share		60%	10%	2%	12%	12%	83%	4%	3%	1%	91%	9%	100%
Power plant yield		34%	30%	25%	29%	50%	35%						
CO2 PP emission intensity	t/MWh	1.00	0.91	1.10	0.95	0.40	0.91				0.84		0.76
Installed power	MW	1825	600	630	1230	380	3435	1164	464	54	5117	1800	
Capacity factor		81%	40%	9%	24%	75%	60%	9%	15%	39%	44%	13%	

Source: MEMEE, ONE, Beicip-Franlab

The thermal power plants are mainly coal power plant: for instance, Jorf Lasfar coal plant (1360MW) produced 50 % of the total power. The gas is used in the GCC power plant of Tahaddart (380MW) as base load. Gas availability is limited to the transport fee of the GME pipeline.

The peak load power is made by 3 ways: gas turbine burning heavy fuel oil, a pumping storage plant (PSP) of 464MW and the hydro power plants of 1200 MW.

The share of hydro power plants in the power production mix is very dependant to rain falls. These rain falls can vary significantly from one year to another as shown in the following graphs. Furthermore, because the GDP of Morocco is very linked to the agriculture sector, the priority usage of water is given to agriculture at the expense of power production.

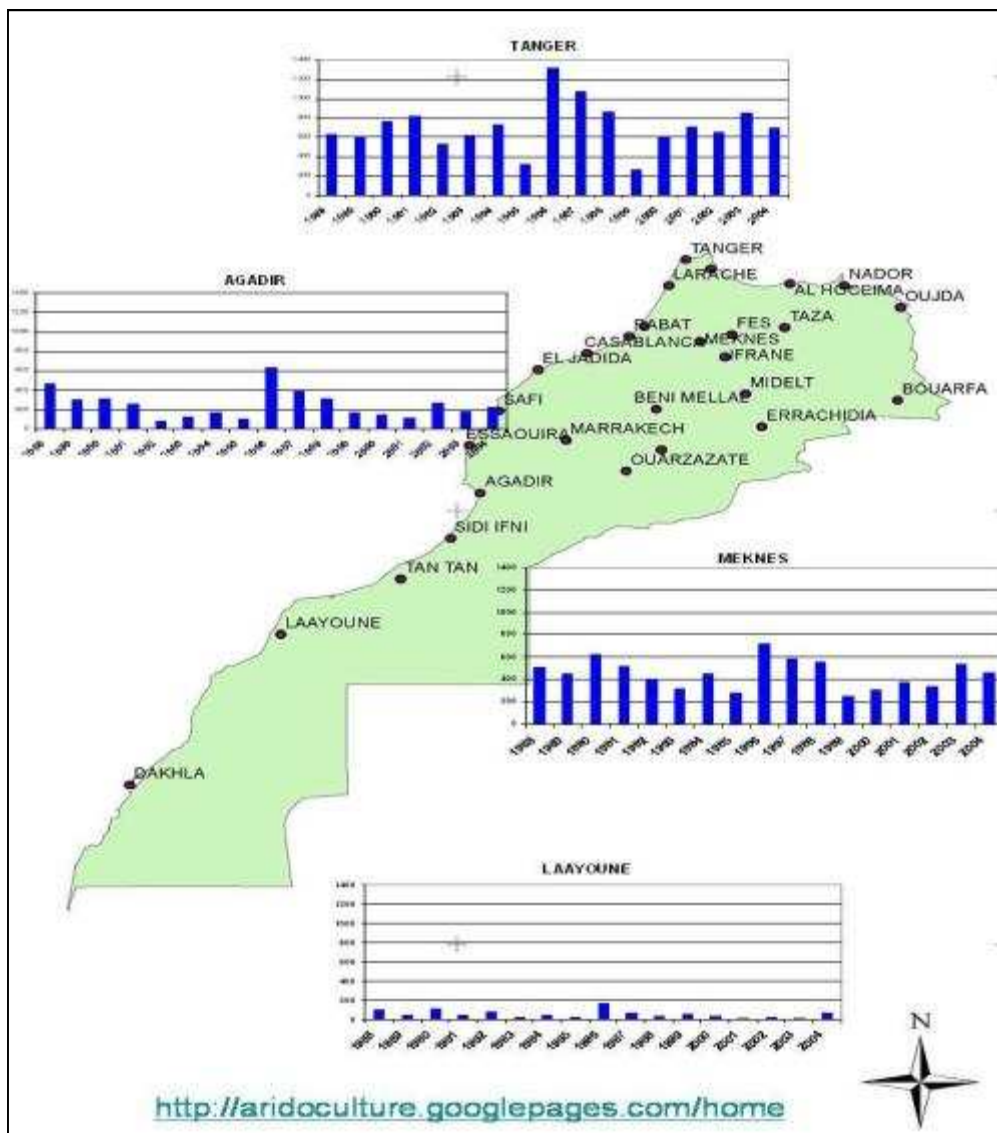

Source : Système d'aide à la décision agricole (SAADA)

**Figure 3-4 Spatial and temporal distribution of rainfall (mm) in Morocco**

Morocco has around 110 major dams with only 20 having the capability of power production. The water reserves are calculated for multi-year reserves in order to satisfy the agriculture needs even during dry years.

However since 2005 Morocco has been using a pumping storage plant (PSP) in Afouer which produces around 30% of its hydro power.

In 2006 Morocco was importing 9% of its electricity. This share is now continuously increasing, showing an important deficit of power production facilities and the poor competitiveness of its reserves power plant burning expensive fuel oil.

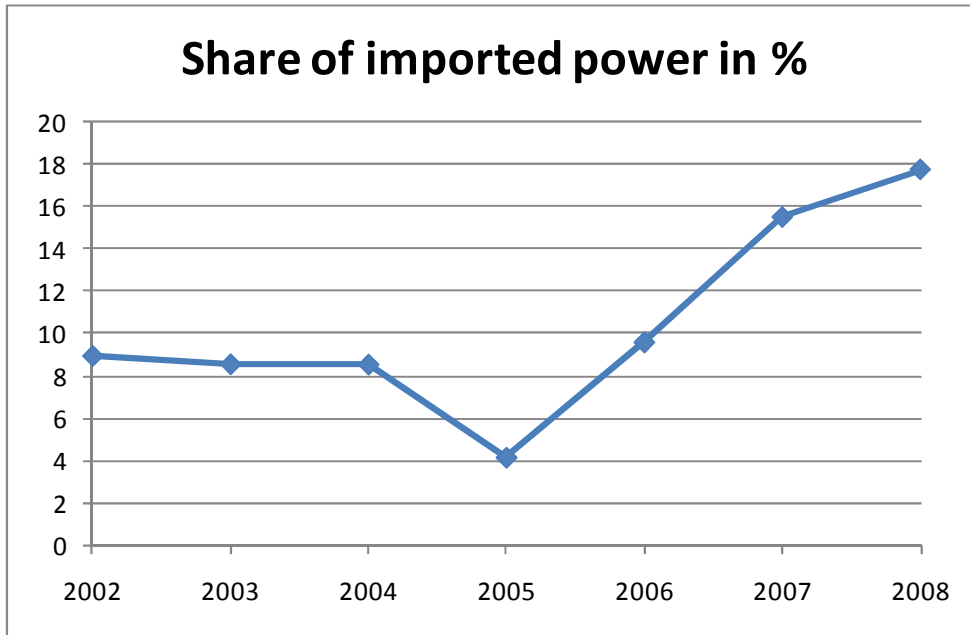

Source: ONE

Figure 3-5 Morocco power importation

The deficit of power production plant is detrimental to the peak demand (as shown in the graphics provided by ONE) which is late in the evening at 22 pm with the new official time GMT+1 adopted by Morocco during summer in 2008 or at 21 pm with the old system of GMT in 2007.

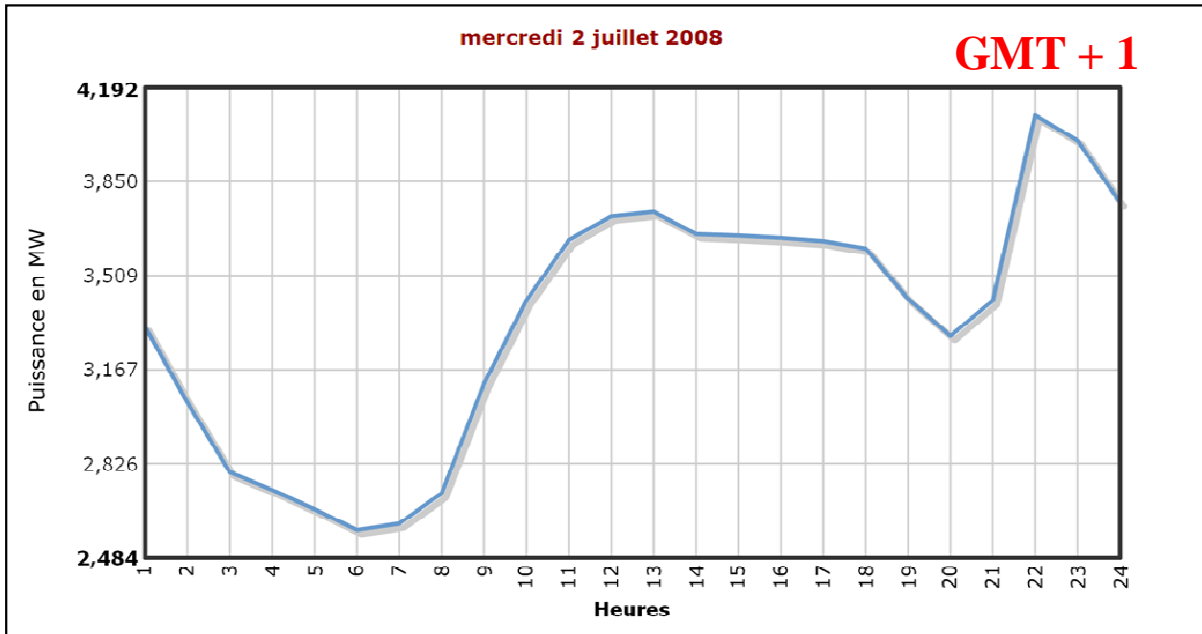

Source: ONE

Figure 3-6 ONE power peak demand - 2008

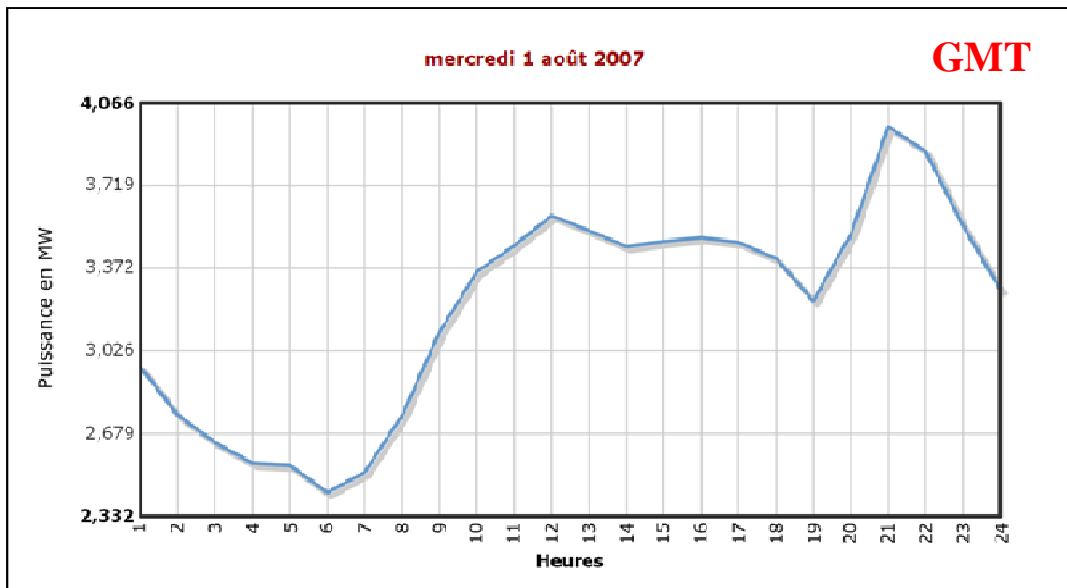

Source: ONE

**Figure 3-7 ONE power peak demand - 2007**

This explains why ONE is taking measures on the demand side to smooth this peak. Accordingly, different power prices are offered reflecting the supply and demand balance. Other measures are taken such as subsidizing the replacement of incandescent light bulbs by compact fluorescent lamp (CFL) which consumes 5 times less power.

### 3.4 Final consumption

Morocco statistics have been improved in the last years anyhow it is still quite difficult to establish an accurate picture of the energy usage in Morocco. The figure shown hereafter has been corrected based on information received from MEMEE and balance calculations made of the usage of petroleum products. The transport consumption share has been increased compare to the IEA figures based on number of vehicles in activity and data given by MEMEE for 2007. Also in the statistic definition of Morocco private transport (i.e. private cars) was accounted for the domestic consumption while the IEA includes it in the transport sector.

The share of the different sector is given hereafter:

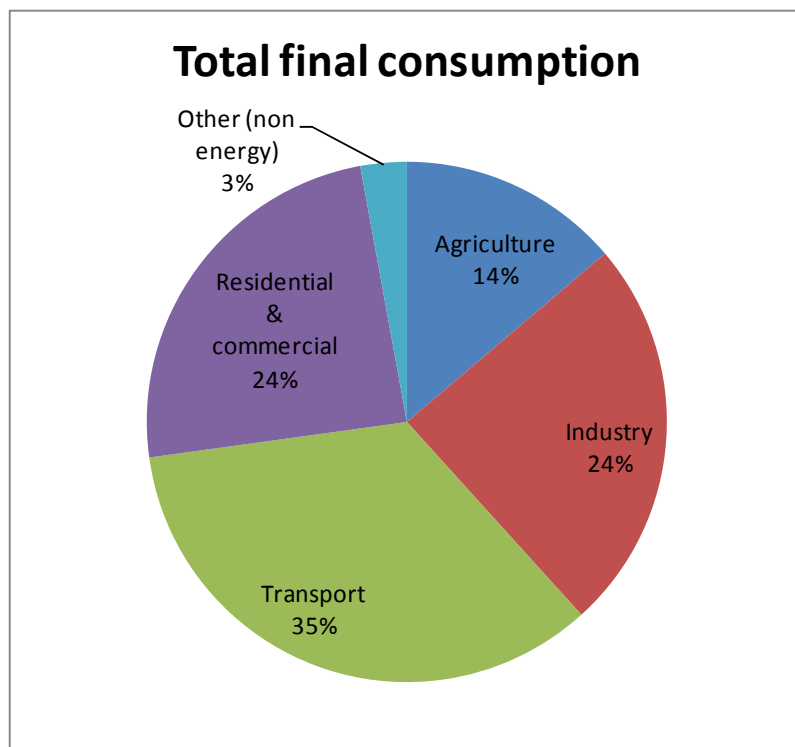

Source: MEMEE, IEA, Beicip-Franlab

**Figure 3-8 Final energy consumption of Morocco**

### 3.4.1 Agriculture

The agriculture sector is vital for Morocco. It contributes for a large part to the GDP growth and rainy years can boost Morocco growth.

The energy consumed in this sector is mainly for agriculture machines but also for water pumping and greenhouse heating.

### 3.4.2 Industry

The industry sector is shared between heavy industry like cement or phosphates where statistics are available and small industries for which very few statistics exists. The share of energy consumption per subsector is given hereafter:

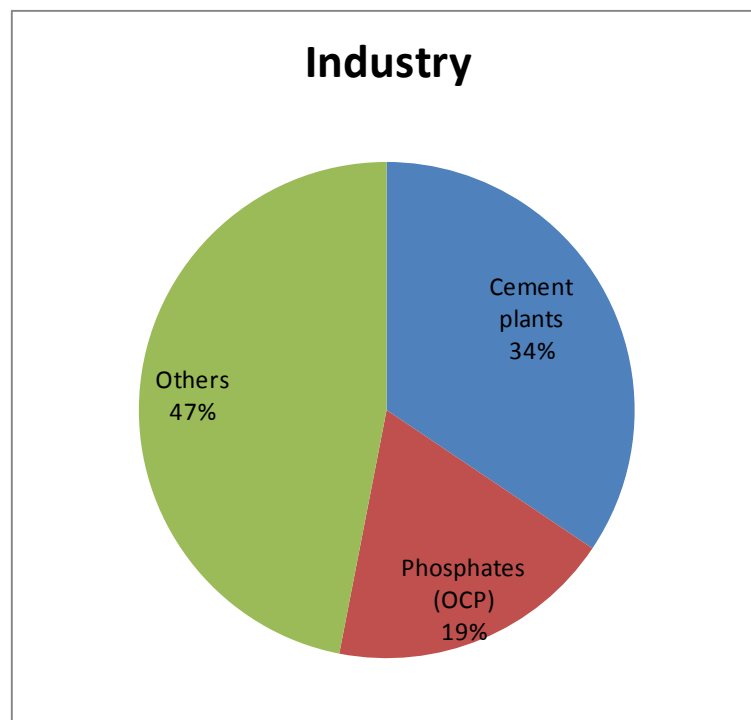

Source: MEMEE, OCP, Beicip-Franlab

**Figure 3-9 Final energy consumption – industry sector**

The energy consumption of phosphates sector has been given by OCP. Cement plants energy consumption has been calculated by Beicip-Franlab on the basis of cement production. However the split into other industrial sectors is unknown as no statistical data exists.

### 3.4.3 Transport

For the transport sector, Beicip-Franlab shared the consumption in three subsectors – good transportation, passenger commercial transportation and private transportation. The figures have been reviewed by Beicip-Franlab taking into account the number of vehicles existing in the registration files of Morocco.

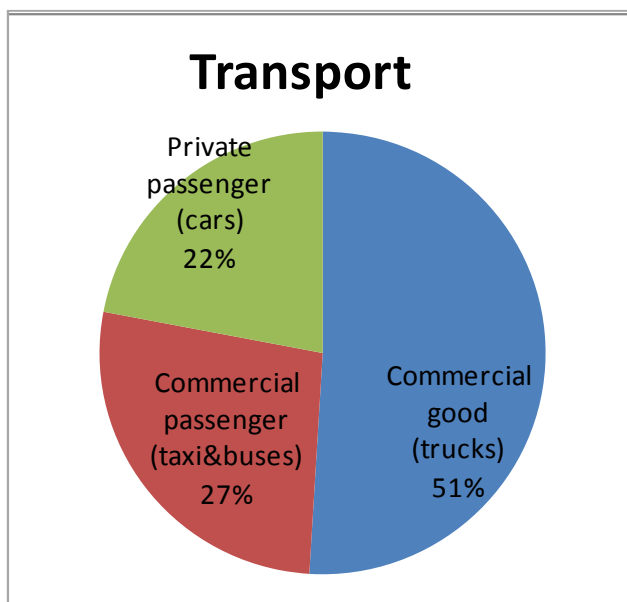

Source: MEMEE, Beicip-Franlab

Figure 3-10 Final energy consumption – transport sector

### 3.4.4 Residential & commercial

Based on a study made in 2005 for the usage of butane comparatively to other source of energy, it is possible to split the energy usage by categories.

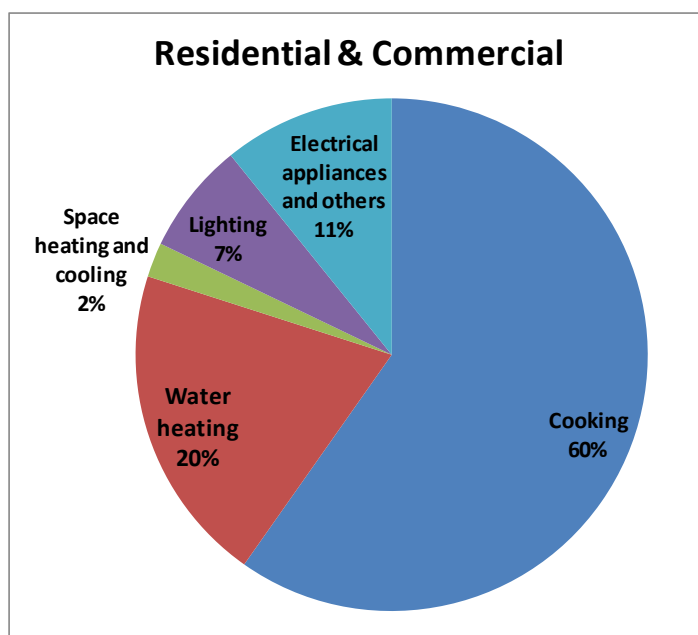

Source: Groupement des Pétroliers du Maroc (GPM), MEMEE, Beicip-Franlab

Figure 3-11 Final energy consumption – residential and commercial

### 3.5 CO2 emissions from fuel combustion

Here below the direct CO2 emissions from fuel combustion by sector is presented. The power plants and the transport sector are the main sources of CO2 emissions respectively.

**Table 4 CO2 emissions from fuel combustion balance**

CO2 emissions		Coal	Fuel	GT fuel	Gasoil	Jet	Gasoline	LPG	Pet. prod.	Gas	Tot. fos.	Share per sector	Share per sector of indirect emission through power	Share per sector including indirect emission through power
CO2 emission intensity	t/toe	3.96	3.24	3.24	3.10	2.99	2.90	2.64	3.01	2.35	3.26			
<b>Total emissions</b>	<b>Mt</b>	<b>14.8</b>	<b>4.5</b>	<b>0.5</b>	<b>12.0</b>	<b>1.2</b>	<b>1.1</b>	<b>4.9</b>	<b>24.1</b>	<b>1.5</b>	<b>40.4</b>	<b>100%</b>	<b>41%</b>	<b>100%</b>
Refineries	Mt				0.3				0.3	0.3	0.7	2%	0%	2%
Power plants	Mt	12.9	1.9	0.5					2.5	1.0	16.4	41%	0%	0%
Agriculture	Mt				2.5			1.1	3.6		3.6	9%	4%	13%
Industry	Mt	1.9	2.5		0.7			0.3	3.5	0.1	5.5	14%	19%	32%
Transport	Mt				8.3	1.2	1.1		10.6		10.6	26%	0.5%	27%
Residential & commercial	Mt				0.1			3.6	3.7		3.7	9%	17%	26%
Share per fuel		37%	11%	1%	30%	3%	3%	12%	60%	4%	100%			

Source: ENERDATA, IEA, MEMEE, Beicip-Franlab

If power emissions are split across the end user sector, it appears that industry account for 32 % of direct + indirect emissions followed by transport 27%, residential & commercial 26% and the agriculture 13%. Decreasing the emission intensity of the power production (i.e. the amount of CO2 per unit) will decrease the emission of industry and residential sectors. Currently transport sector is nearly independent from the power sector emissions, only some trains are powered with electricity.

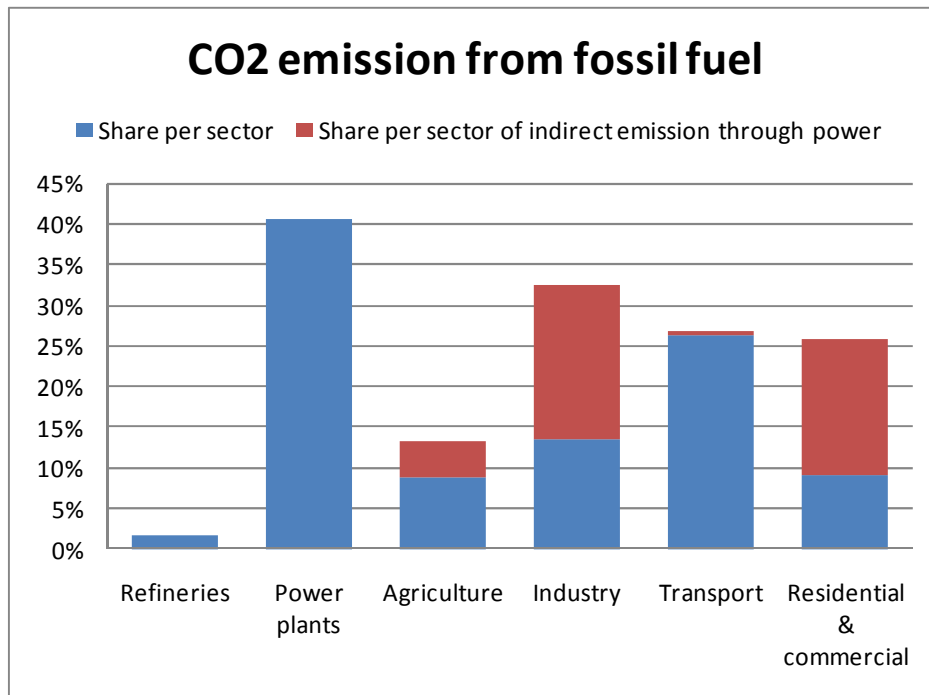

Source: ENERDATA, IEA, MEMEE, Beicip-Franlab

**Figure 3-12 CO2 emission from fossil combustion**



### 3.6 CO<sub>2</sub> from fuel combustion and greenhouse gases

In developed countries CO<sub>2</sub> from fuel combustion accounted for 80% of the GHG emission while in Morocco this share represented only 53% in 2005, although it shows the highest increase between 1990 and 2005. The other important GHG are CH<sub>4</sub> and NO<sub>2</sub> coming from agriculture and waste management.

These gases should be followed and mitigations measures to decrease their amount are already available, however it is not the object of this study related to low carbon energy.

**Table 5 Morocco greenhouse gas emissions**

Greenhouse gas emissions	1990	2005	Evolution	2005 Share
	<b>Mt of CO<sub>2</sub>eq</b>			
CO <sub>2</sub> - fuel combustion	19.6	39.3	101%	53%
CO <sub>2</sub> - others	4.7	5.8	23%	8%
CH <sub>4</sub>	9.1	13.2	45%	18%
N <sub>2</sub> O	14.4	15.5	8%	21%
HFCs	0	0	0%	0%
PFCs	0	0	0%	0%
SF <sub>6</sub>	0	0	0%	0%
Total CO <sub>2</sub> eq. no fuel combustion	28.2	34.5	22%	47%
<b>Total CO<sub>2</sub> eq.</b>	<b>47.8</b>	<b>73.8</b>	<b>54%</b>	<b>100%</b>

Source: IEA

In addition to these greenhouse gases the forest net emission is also positive, meaning that more forest is burnt than what is growing.

**Table 6 Morocco net greenhouse gas emissions for forestry**

Greenhouse gas emissions	1994	2000	Evolution
	<b>Mt of CO<sub>2</sub>eq</b>		
Net emissions forestry	3.5	3.6	2.6%

Source: MEMEE

Therefore biomass used for energy usage should be carefully followed, if this biomass is not replaced, it has to be qualified as unsustainable biomass and a high emission factor of 4.6 tCO<sub>2</sub>/toe (higher than coal 3.96 tCO<sub>2</sub>/toe or LPG 2.27 tCO<sub>2</sub>/toe) should be applied. This means that another 2.1 Mt/y of CO<sub>2</sub> emissions must be added to 40.4 Mt/y for the 0.45 Mtoe/y of used biomass in the energy mix.

Using biomass as renewable energy should be cautiously followed in parallel with sustainable replacement of this biomass.

The other drawback of biomass is that very inefficient burning devices are used to burn it. Efficiency can be as low as 10% which means that with unsustainable biomass the CO<sub>2</sub> emission could be 18 times higher than LPG used with an efficiency of 90%.

### 3.7 CO2 emissions benchmarking

Morocco is not a big CO2 emitter if it is compared to its neighbours: Moroccan emission of CO2 from fuel combustion is respectively 2 and 8 times lower than ones of Algeria and Spain.

In addition, as shown in the table below, Moroccan population has the smallest CO2 emission per capita compared to its neighbours with only 1.30 tCO2 per capita.

**Table 7 CO2 emissions benchmarking**

2006	Power consumption	CO2 emission intensity	Power CO2 emissions	Total emission from fuel combustion	Share of CO2 power	Population	Emission per capita
	TWh	gCO2/kWh	MtCO2	MtCO2	% of TPES	Millions	tCO2/cap
Germany	854	404	345	821	42%	82	9.97
France	615	85	52	377	14%	63	5.96
United kingdom	410	505	207	547	38%	59	9.28
Italy	366	404	148	450	33%	61	7.43
Spain	299	350	105	336	31%	44	7.61
EU 27	4124	354	1460	4022	36%	494	8.14
Algeria	35	688	24	90	27%	33	2.69
Egypt	115	470	54	151	36%	74	2.04
Libya	24	879	21	45	47%	6	7.50
<b>Morocco</b>	<b>22</b>	<b>759</b>	<b>16</b>	<b>40</b>	<b>41%</b>	<b>31</b>	<b>1.30</b>
Tunisia	14	546	8	20	39%	10	1.95

However, due to the large share of coal in the power production balance, the CO2 emission intensity of power in Morocco is one of the highest around the Mediterranean Sea with 759 gCO2/kWh.

In contrast, with large shares of nuclear and hydroelectricity in its power production balance, France has the lowest emission intensity with only 85 gCO2/kWh away from Morocco and Libya.

Even if Morocco is not a large “per capita” emitter, indeed this is a developing country with a large part of population still involved in the agricultural sector, it can be seen from this benchmarking that there is a large potential for progress in term of emission intensity in the power sector.

## 4 MOROCCO STRATEGY FOR 2030

### 4.1 Targets of the Morocco strategy

Targets of the Morocco energy strategy, for the period 2008-2030, have been presented during the first “Assises de l’Energie” in March 2009 and are developed in a PowerPoint presentation of MEMEE dated 28/02/09.

In this strategy, renewable energies (RE) are set at 15% of the energy mix.

In a first step, it is considered that there is no energy efficiency (EE) improvement. Power consumption is set to increase by 6.5%/year, petroleum products by 3%/year and primary energy consumption by 5%/year.

This exercise leads to the following table.

**Table 8 Morocco energy strategy: TPES projection without EE**

	2006	2012	2020	2030
EE	0.0%	0.0%	0.0%	0.0%
Hydro	1.6%	1.2%	0.8%	0.5%
Wind	0.1%	6.8%	7.0%	10.9%
Solar	0.0%	0.0%	2.2%	2.8%
Biomass (sust.)	0.0%	0.0%	0.0%	0.8%
Nuclear	0.0%	0.0%	0.0%	4.2%
Gas	3.7%	5.0%	3.4%	2.1%
Oil & petroleum products	63.4%	56.5%	42.9%	38.7%
Coal	27.9%	28.0%	42.0%	39.0%
Biomass (unsust.)	3.4%	2.5%	1.7%	1.0%
Total	100%	100%	100%	100%
Total RE	2%	8%	10%	15%
TPES Mtoe/y	13.4	18.0	26.6	43.3
EE Mtoe/y	0.0	0.0	0.0	0.0
Pet. prod. Mtoe/y	8.5	10.2	11.4	16.7
Power TWh/h	21	31	51	95
Total RE in power prod	4%	18%	20%	26%
Total wind in power prod	0%	15%	14%	19%

Source: MEMEE

Then in a second step, it is supposed that measures are taken that would in fact improve EE by 15%.

Gas is used at the maximum of the GME transport fee rate. Petroleum products share is adapted to lower demand and coal balances the power requirement.

Final projection of TPES is given here below.

**Table 9 Morocco energy strategy: TPES projection with EE**

	2006	2012	2020	2030
EE	0.0%	4.0%	9.0%	15.0%
Hydro	1.6%	1.2%	0.8%	0.5%
Wind	0.1%	6.8%	7.0%	10.9%
Solar	0.0%	0.0%	2.2%	2.8%
Biomass (sust.)	0.0%	0.0%	0.0%	0.8%
Nuclear	0.0%	0.0%	0.0%	4.2%
Gas	3.7%	5.0%	3.4%	2.1%
Oil & petroleum products	63.4%	54.2%	39.0%	32.9%
Coal	27.9%	26.3%	36.8%	29.8%
Biomass (unsust.)	3.4%	2.5%	1.7%	1.0%
<b>Total</b>	100.0%	100.0%	100.0%	100.0%
<b>Total RE without EE</b>	2%	8%	10%	15%
<b>TPES Mtoe/y</b>	13.4	17.3	24.2	36.8
<b>EE Mtoe/y</b>	0.0	0.7	2.4	6.5
<b>Petroleum prod. Mtoe/y</b>	8.5	9.8	10.4	14.2
<b>Power TWh/h</b>	21	29	46	81
<b>Total RE with EE</b>	2%	8%	11%	18%
<b>Total RE in power prod.</b>	4%	19%	22%	31%
<b>Total wind in power prod.</b>	0%	16%	15%	22%

Source: MEMEE

Our comments regarding each type of energy are given thereafter.

Analysis of the impact of this strategy is presented in section 4.2.

#### 4.1.1 Renewable energy

The renewable energy target is set at 15% of the TPES which means 7300MW of installed RE power with an average capacity factor of 37.5%. The RE directly used for heating purpose as biomass or solar heaters are not accounted for this target.

##### 4.1.1.1 Hydropower and pumping storage plant (PSP)

As explained before, due to uncertainty in rain falls and shortage of water in Morocco, limited development of hydro power is envisaged. Some small dams will be added to the system as the 40 MW one of Tanafnit.

A second PSP located in Abdelmoumen is scheduled for 2013 with a capacity of 420 MW for 6 hours production. This PSP is reusing as its lower storage, the existing water storage of Abdelmoumen dam built for irrigation purpose. In addition, an upper storage of 1.3 Mm<sup>3</sup> is built. The available height for this PSP is 600 m using natural elevation provided by the Atlas Mountains. The PSP is designed for peak power demand only and not really to store power from RE. However it will help to manage the increased share of wind energy to 15% in 2012.

#### 4.1.1.2 Wind

The CDER (centre de développement des énergies renouvelables) has measured from 1990 to 2001 the wind speed in almost 40 places in Morocco. This campaign of measurement provided the following map published in a wind Atlas in 2007 showing a large potential for wind energy.

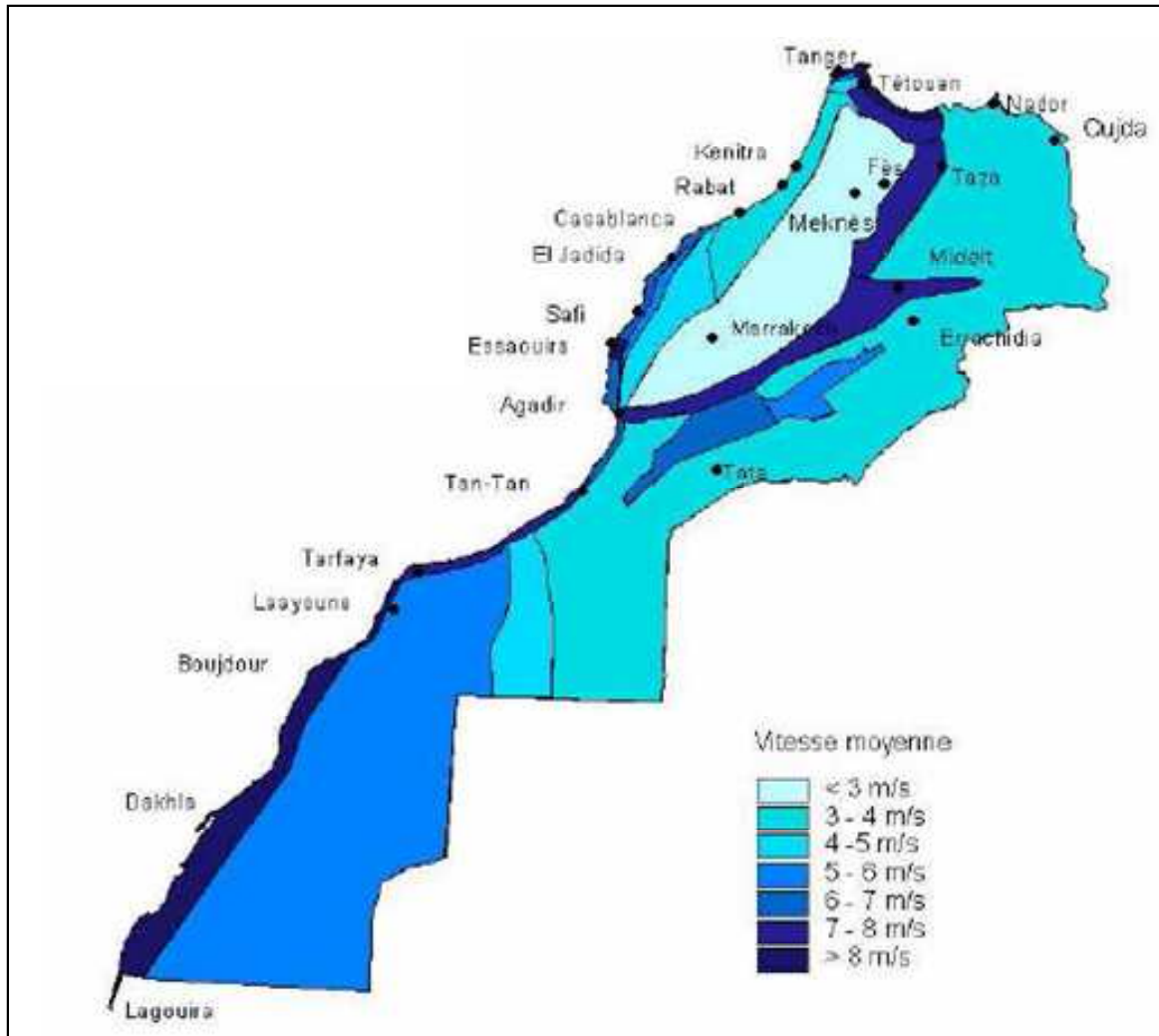

Source: CDER

**Figure 4-1 Morocco wind energy potential**

The technical potential has been evaluated at 4896 TWh/y by the CDER which means 50 times more than envisaged for Morocco power demand. This power would require installing 2448 GW meaning an average capacity factor of 23% which is above the ones measured in Europe. However MEMEE estimates that the “good” wind potential is only 6 GW of installed power in 2030.

If we consider a reasonable ratio of 10 MW of installed power per square kilometer, the estimation of the CDER means 244 000 km<sup>2</sup> of Moroccan territory that are used for wind energy. The estimation of MEMEE limits the need to only 600 km<sup>2</sup> which is a square of 25km\*25km.

From the map of population density a lot of area with good wind potential have also few inhabitants (in the south and in the east), therefore in term of land usage a strong wind penetration can be envisaged.

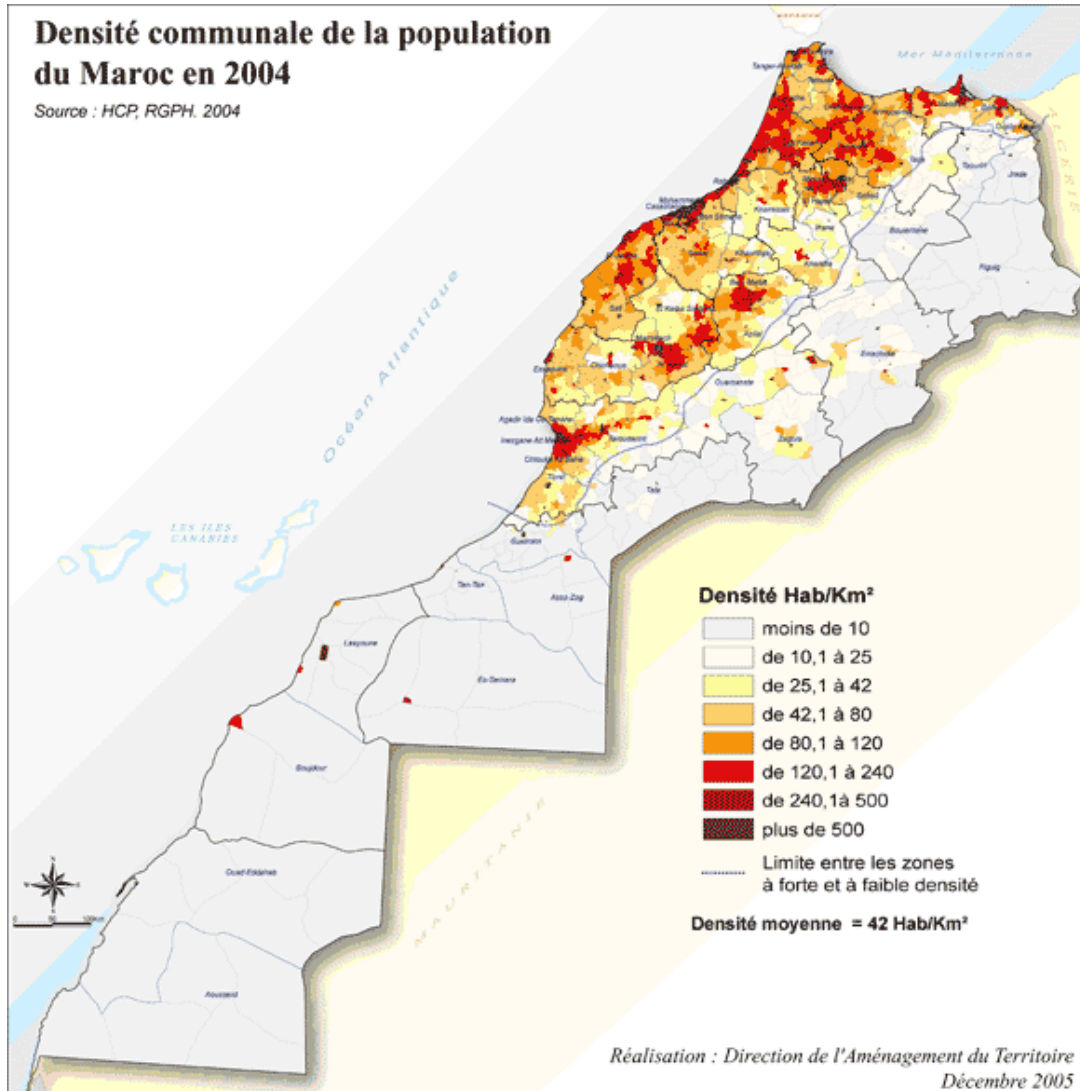

Source: Direction de l'Aménagement du Territoire (Morocco)

Figure 4-2 Morocco population density - 2004

Another map is provided by MEMEE with location of the best wind condition envisaged to develop its wind farm, i.e. with a capacity factor higher than 35%. Beicip-Franlab added squares of 25\*25 km on this map to show that 6 GW represents only a small part of the available land. In addition, the used land for wind energy would be still free at 99% for agriculture usage or industry.

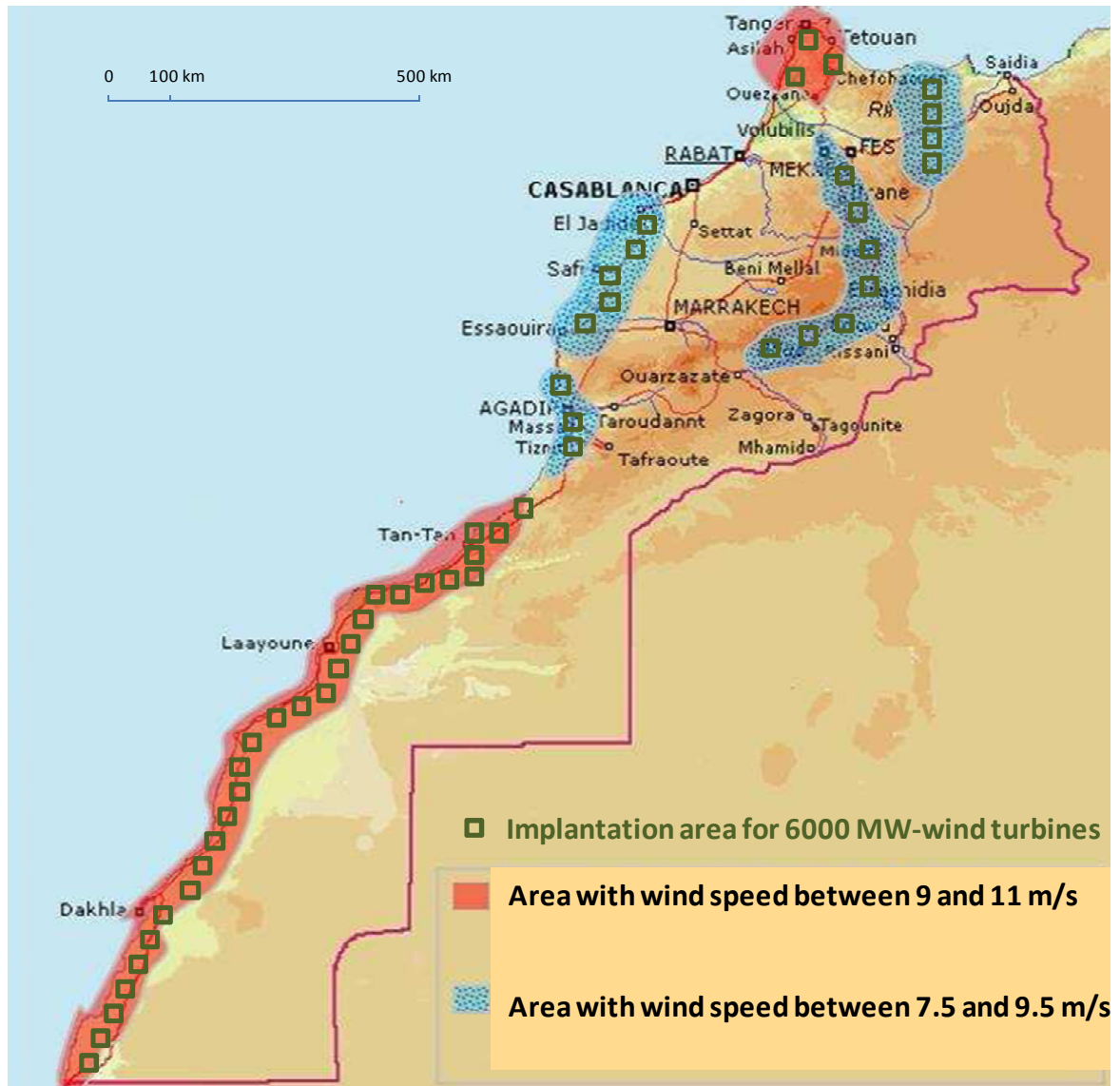

Source: MEMEE, Beicip-Franlab

#### Figure 4-3 Potential of implantation of wind turbines in Morocco

Taking into account population and geographical constraints of Morocco Mountains, we can place at least 50 squares, each representing the 6 GW target of MEMEE. This means 300 GW of installed power with a production of 920 TWh, 10 times the envisaged Morocco power consumption in 2030 or the present consumption of Germany.

The potential is large in term of quantity and in term of quality (stability of wind) the best potential is located in the south.



Data provided by the CDER for Tarfaya (south of Morocco) are impressive in term of wind quality. First the direction is nearly the same as shown below which means low maintenance cost for the wind mills.

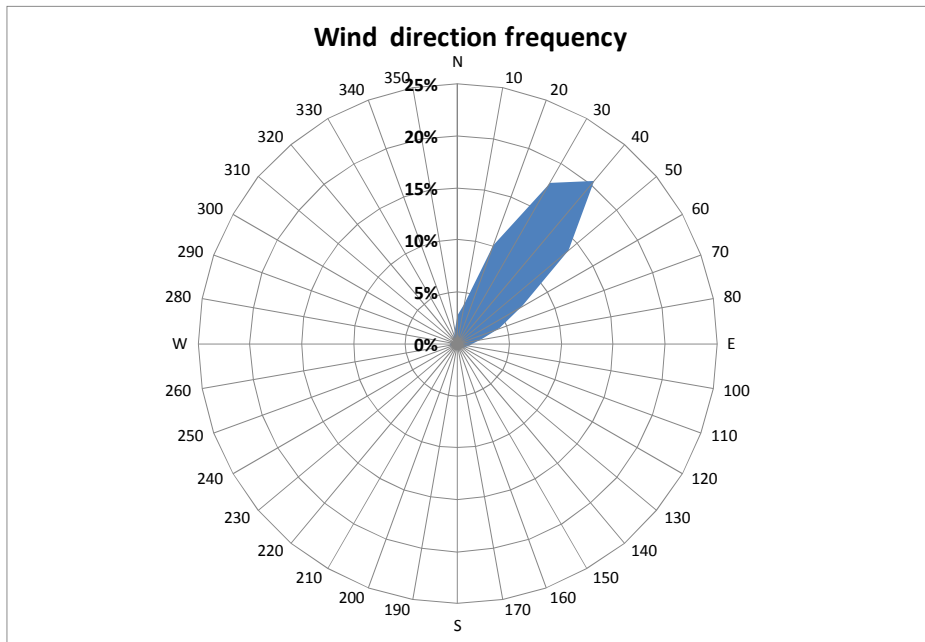

Source: CDER

**Figure 4-4 Tarfaya: wind direction frequency**

Second, the speed of the wind is quite constant along the day as shown hereafter.

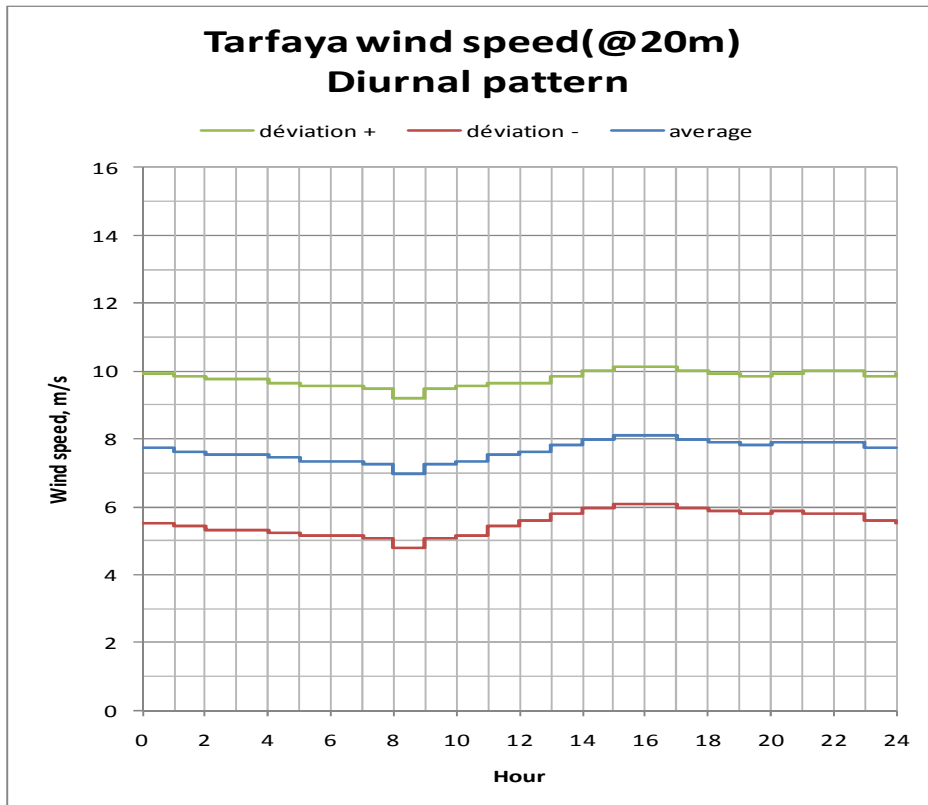

Source: CDER

Figure 4-5 Tarfaya: daily wind speed (@20m)

The periods of calm are very small and very low in frequency

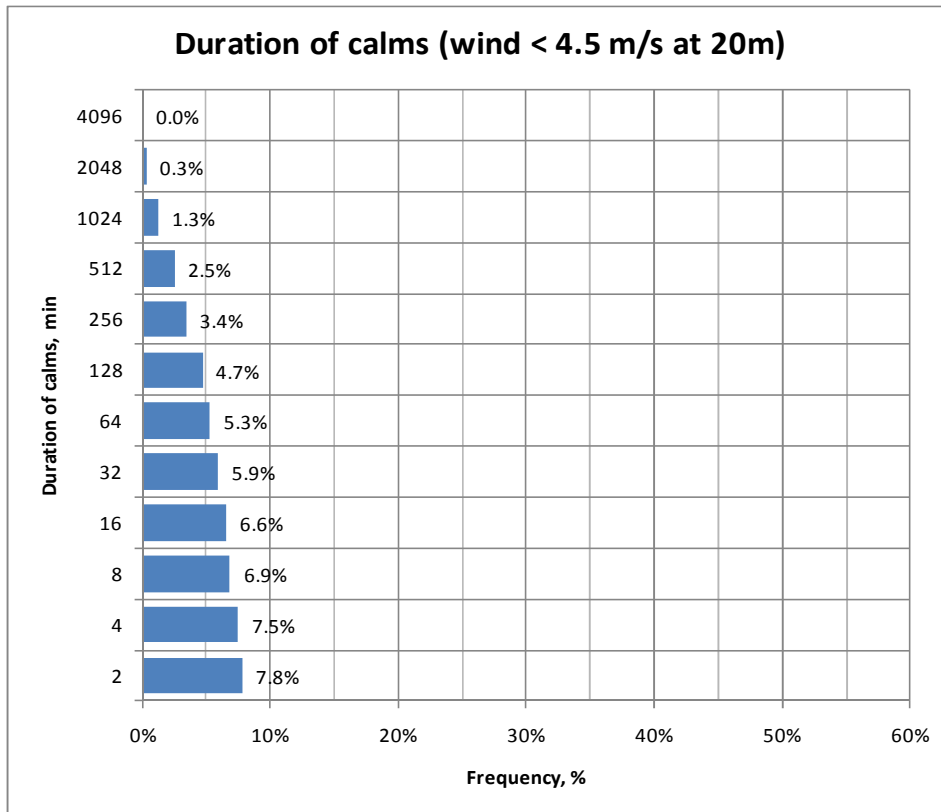

Source: CDER

**Figure 4-6 Tarfaya: duration of calms of the wind (@20m)**

Note that period of calm of more than 32 hours cannot be measured. This figure is very important for the evaluation of the availability of wind energy.

During the year wind power is quite predictable as shown on the following graph:

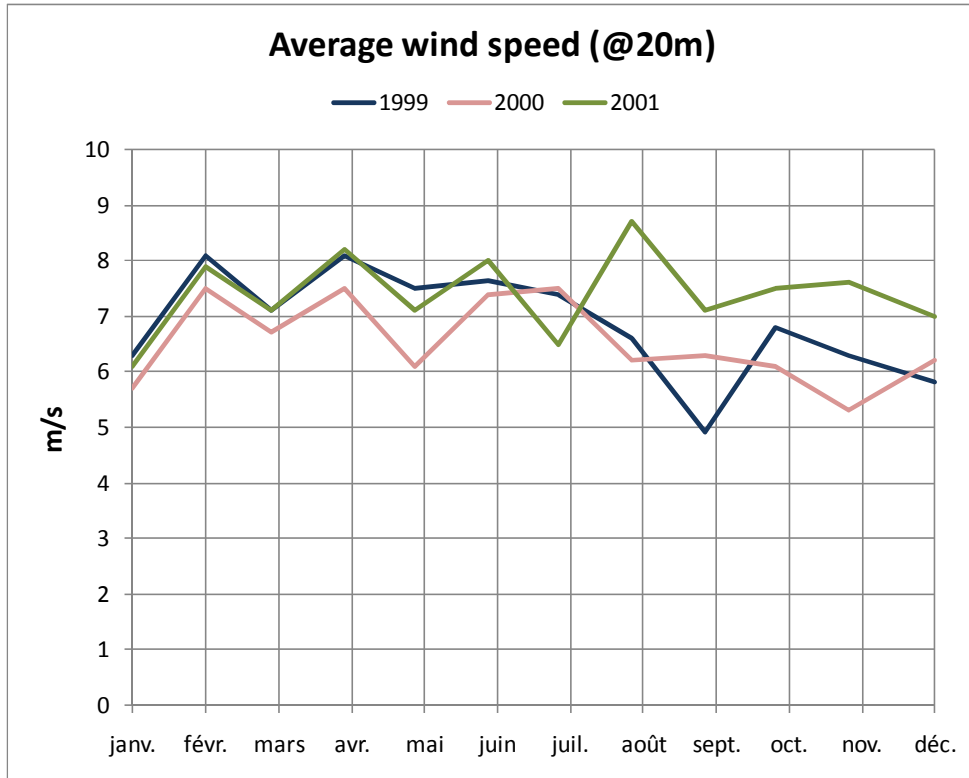

Source: CDER

Figure 4-7 Tarfaya: annually wind speed (@20m)

The wind is also quite concentrated in term of wind frequency, which means that produced power will oscillate less compared to usual wind turbines.

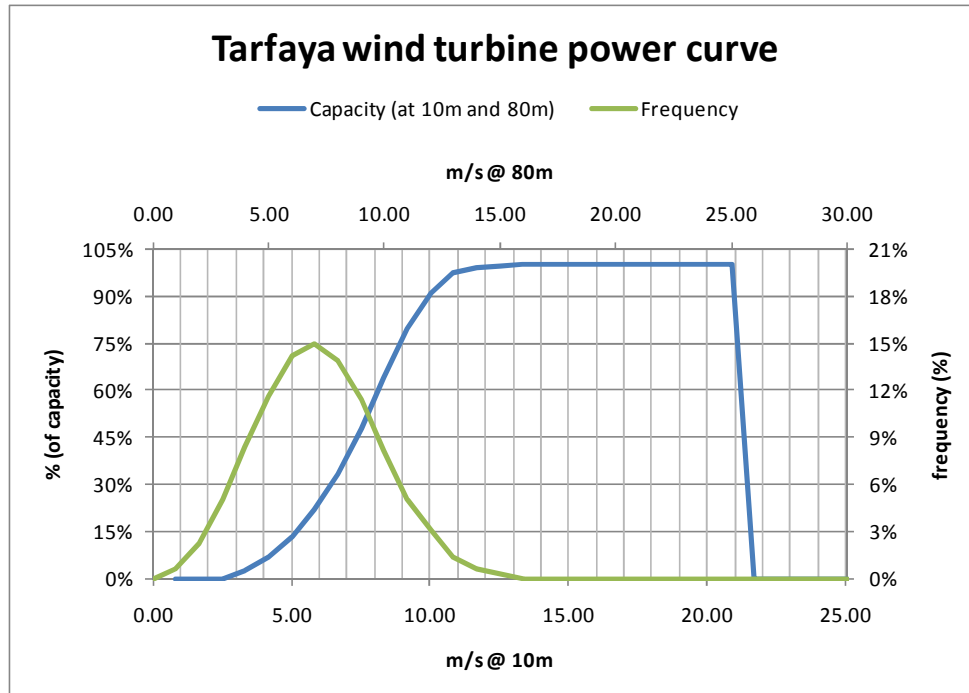

Source: CDER

Figure 4-8 Tarfaya: wind turbine power curve

Such wind conditions allow expecting wind capacity factor higher than 40% meaning an interesting cost of power produced, nearly half of the one produced in Europe with onshore wind farms. The wind conditions in the south of Morocco are equivalent to the one of offshore wind in north Europe but in offshore the investment is multiplied by a factor of 2.

As a conclusion the figure of 6000 MW can be understood as maximum for a wind penetration of 20 % in the grid. This figure is a common ratio of power producers that used to manage thermal power plant. This is not demonstrated: combining wind power to hydro power through power storage plant, Morocco can envisage much higher wind penetration.

### 4.1.1.3 Solar

#### 4.1.1.3.1 Solar power

Solar potential of Morocco is also huge. The average solar radiation amounts to 5kWh/m<sup>2</sup>/d, around 1.5 times the average of Europe. In east and south part of Morocco, the number of cloudy days is very low.

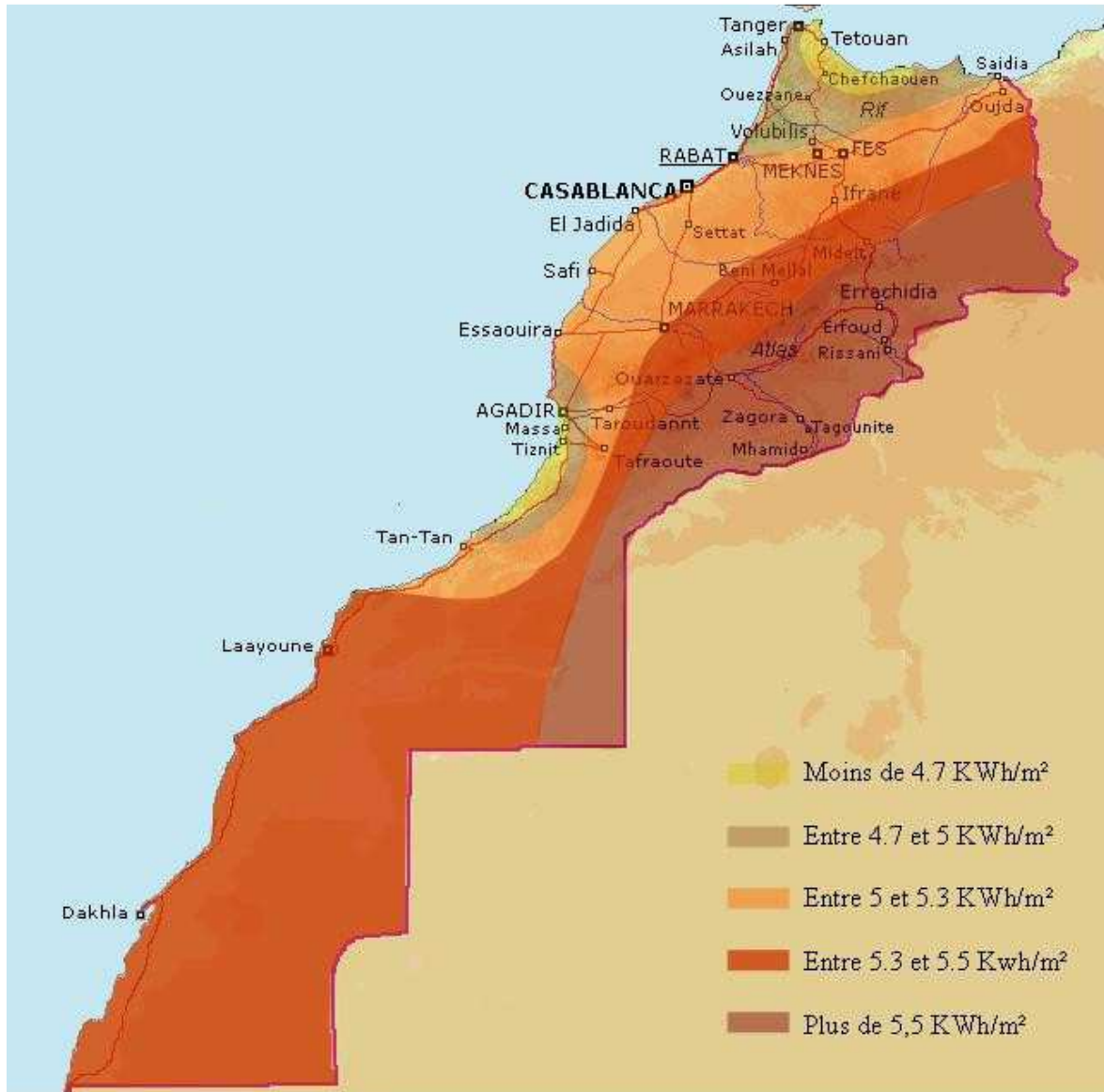

Source: CDER

**Figure 4-9 Morocco solar potential**

For producing power two main technologies exist: the photovoltaic (PV) cells and the concentrated solar power (CSP).

PV cells are easy to install, operating & maintenance cost are very low but their price is still very high. Their efficiency is low around 19% for morocco condition. They can only produce during the sunny hours of the day which lead to a low capacity factor of around 21%.

The CSP technology is cheaper than PV per installed power capacity; the efficiency is the one of a thermal power plant based on steam cycle. Depending on the CSP technology used which allow more or less superheating the steam, the overall efficiency can be

estimated between 20 to 35 %, meaning that 65% to 80 % of the primary heat should be removed with water cooling or air cooling. In both case this is not easy in dry and hot area as desert.

As a matter of comparison a gas combined cycle (GCC) with a yield of 54 % will use 1.5 m<sup>3</sup>/MW for refrigeration whereas a CSP with 30% thermal yield will use 4 m<sup>3</sup>/MW (2.6 times more). The refrigeration need is high due to poor CSP yield. We can say that almost 70 % of the investment for collector is used to produce lost heat.

Common sense of thermodynamic should drive to hybrid system with a gas turbine allowing superheating the steam produced by solar energy as the scheme developed for Ain Beni Mathar ISGC plant shown here below in its initial configuration.

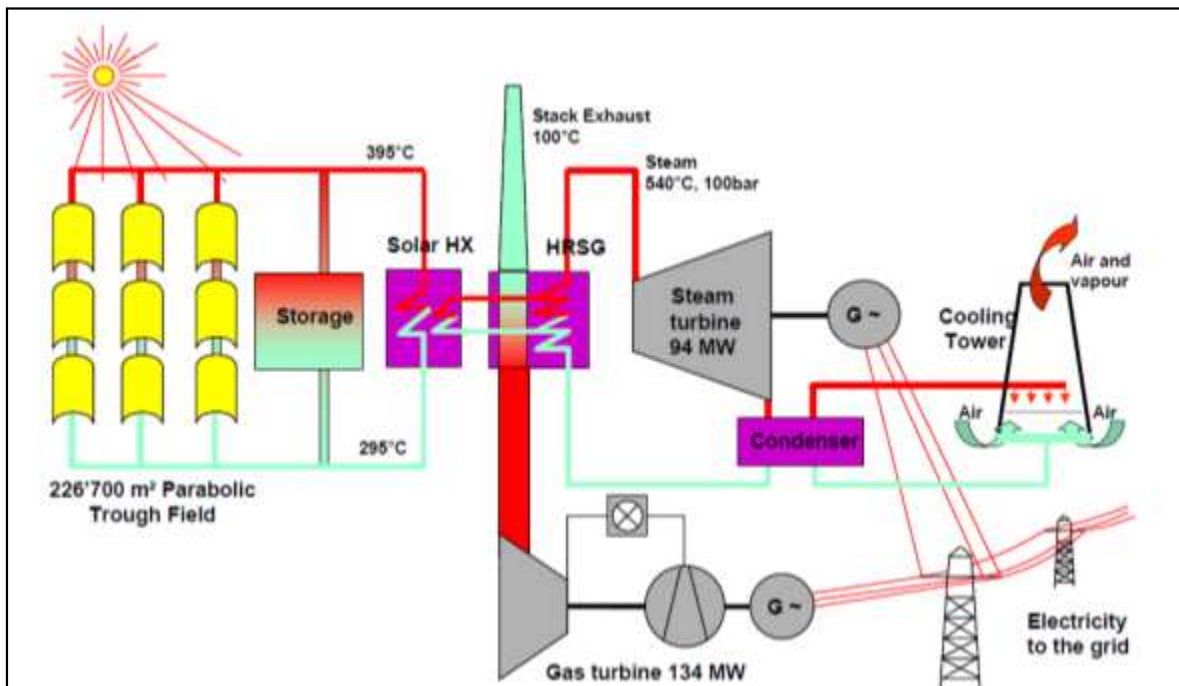

Source: ONE

**Figure 4-10 Ain Beni Mathar ISGC plant scheme**

The contribution of the solar energy was 3.5% meaning 56 GWh for a total of 1590 GWh produced per year. With a capacity factor of 31% compared to 80% for the gas turbine part, the installed power for solar could be estimated at 20 MW on a total installed power of 228 MW. In term of land usage solar is equivalent to wind with installed power of 10 MW/km<sup>2</sup>. However in the case of solar, used land cannot be shared as for wind power.

It is worth mentioning that protection from wind and especially sand wind could be an issue for PV and CSP. Furthermore, the cleaning of mirrors and cells might require water which may be not easily available.

The experience gained on Ain Beni Mathar in term of operating maintenance cost will be very useful to evaluate the potential of the technology.

MEMEE plans to build 1000 MW of CSP and 400 MW of PV by 2030 for power production.

#### 4.1.1.3.2 *Solar water heating*

The other application of solar energy is direct water heating. This will decrease the usage of butane for sanitary hot water.

MEMEE plans to install 3 Mm<sup>2</sup> of solar panels by 2030 with an average overall yield of 38% recovered from solar radiation. The expected saving will be 0.180Mtoe/y of butane.

The investment is reimbursed in 10 years with a butane price for the consumer at 746\$/toe with no subsidies, on the other hand with the present subsidized price of 350\$/toe 22 years are needed to reimburse the panels. For the time being Morocco authorities need to support financially the implementation of the solar panels.



#### 4.1.1.4 Biomass

Biomass can be used as a heat producer or as a source of biofuels. The benefit in terms of energy efficiency and CO<sub>2</sub> emissions related to the first generation of biofuels using vegetable oil is quite low. Second generation of biofuels which will not compete with food also getting better energy yield are under preparation.

One most known technology for this second generation biofuels would be gasification of biomass, then Fisher Tropsch synthesis followed by hydrocracking to produce top quality diesel oil. The theoretical efficiency of this route up to the production of gasoil is less than 40%.

Today main foreseen usage of biomass will remains as what it was for centuries, heat production. This heat can be transformed to power in a steam cycle power plant and through a GCC with a gasifier to convert biomass to gas. The burning of biomass allows using waste biomass and sustainable biomass dedicated to this usage. The burning of biomass should be developed with strict constraint on pollutant emissions, especially particulates.

MEMEE plans to installed 400MW of biomass power production by 2030. The supply of biomass to the power plant will have to be managed carefully in order not to lose benefit of biomass in transport costs.

#### 4.1.2 Nuclear

Nuclear can be a very competitive way to produce electricity when fossil fuels are expensive, and its CO<sub>2</sub> emissions can be considered as negligible. It is also a reliable source of base load power, safer than before with 3<sup>rd</sup> generation reactors (as EPR). However the radioactive waste disposal remains an issue and the decommissioning of the reactor as well. There is no proven solution yet.

MEMEE envisages installing one or two power reactors of 700 to 1000 MW each by 2030.

In its energy balance for 2030, one reactor of 1000MW is considered.

There is no political restriction for Morocco to access to civil nuclear, however a complete industry has to be built to develop this energy and the additional cost of this infrastructure can increase drastically the cost of the power produced by only one or two reactors.

### 4.1.3 Gas

Gas has been introduced in 2005 in Morocco with a first GCC plant of Tahaddart with an installed capacity of 380 MW.

A second plant, Ain Beni Mathar, is under construction and will add 472 MW of installed capacity. Both power plants will be fed by the gas given by Algeria as transport fee of the gas sent to Europe through the Maghreb pipeline (GME).

Additional gas supply is still under consideration by MEMEE but the possibility of a LNG terminal was judged as too expensive compared to the coal supply.

Algerian gas is committed to the European market and additional productions are not available for Morocco. The Algerian gas is seen by Europe as a possibility to reduce its dependency to Russian gas and to cope with its CO<sub>2</sub> emission target. At the end of 2009, the 8 bcm/y TransMed pipeline will link directly Algeria to Spain. Gas can therefore be valued at high price by Algeria to European market and non expensive gas may never be available to Morocco if it is not discovered in its own underground.

On the long term Morocco should investigate again the LNG terminal to replace butane which consumption is estimated at 5 Mtoe/y in 2030.

#### 4.1.4 Petroleum products

Petroleum products represent 60% of the TPES, its share will decrease in the coming years as fuel oil will not be used anymore for power production and will be replaced by coal for economic reasons. The other products are predicted to see a growth of 3.6%, meaning a 3% overall growth for all petroleum products. However the share of petroleum products is decreasing as power is increasing by 6.5% and will be based on RE and coal. The growth of petroleum products can be less if energy efficiency target of 15 % is met.

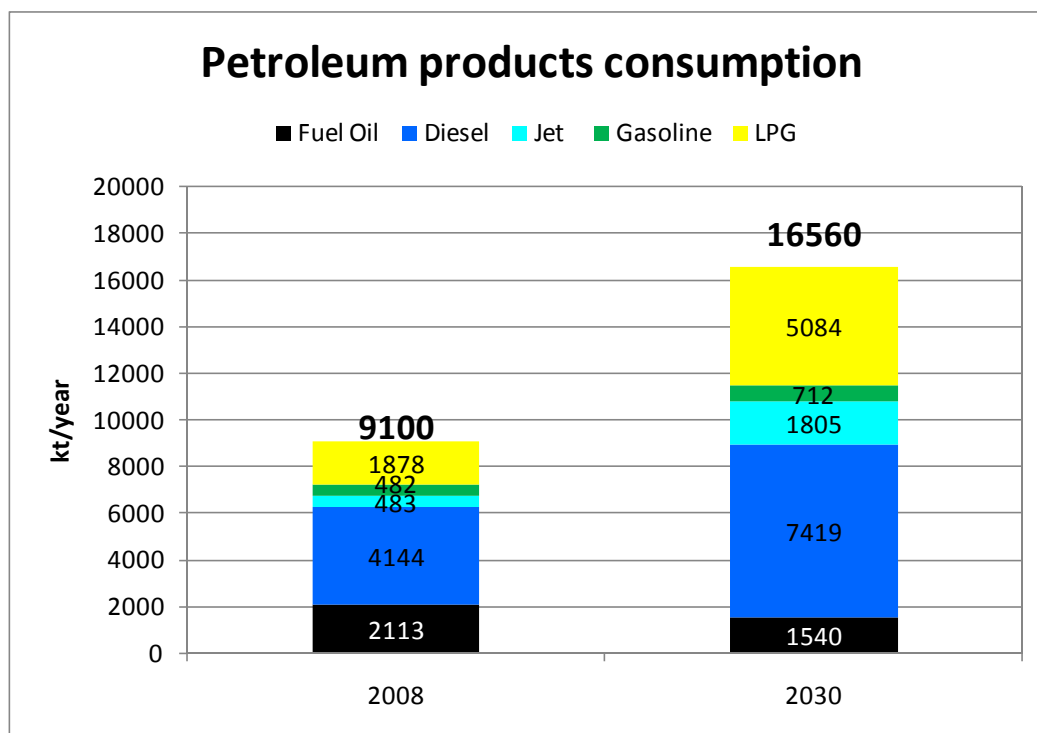

Source: MEMEE

**Figure 4-11 Morocco petroleum products consumption**

However the average growth of the last 6 years of 6% may be difficult to decrease to an average of 3.6% if subsidies are not reviewed deeply.

**Table 10 Morocco petroleum products consumption**

kt/year	2002	2003	2004	2005	2006	2007	2008	Average growth 2002-2008
Propane	116	114	136	152	163	171	180	7.6%
Butane	1144	1226	1288	1347	1454	1596	1698	6.8%
Gasoline	399	385	380	376	388	417	482	3.2%
Jet	282	292	321	368	417	484	483	9.4%
Diesel	3133	3185	3303	3458	3555	3763	4144	4.8%
Fuel oil	1354	1464	1540	1874	1727	1628	2113	7.7%
<b>Total</b>	<b>6429</b>	<b>6665</b>	<b>6968</b>	<b>7574</b>	<b>7703</b>	<b>8059</b>	<b>9100</b>	<b>6.0%</b>
<b>Yearly increase</b>		4%	5%	9%	2%	5%	13%	

Source: MEMEE

Last year was really an amazing year with a 13% increase at the time where petroleum products were at their highest level of the 30 last years. It would be difficult to promote

efficient cars, trucks, public transportation, eco driving, solar water heating if petroleum products are kept at low prices through heavy subsidies.

#### 4.1.5 Coal

Coal has been chosen as the first choice for power production by MEMEE because it is cheaper than natural gas for power production.

To illustrate this fact Beicip-Franlab has made a comparison between coal and natural gas cost for power production.

To a given price of coal, it can be defined an equilibrium price of gas such as the LCOE of both power generations are equal. The resulting figure is a line that is represented (in blue) on the graph here after. This line separates two areas:

- a first area (white) where power generation from coal is cheaper than one from natural gas,
- a second one (pink) where it is more interesting to use natural gas than coal for power generation.

Points illustrating market situations for years 2004 to 2009 are given on the graph.

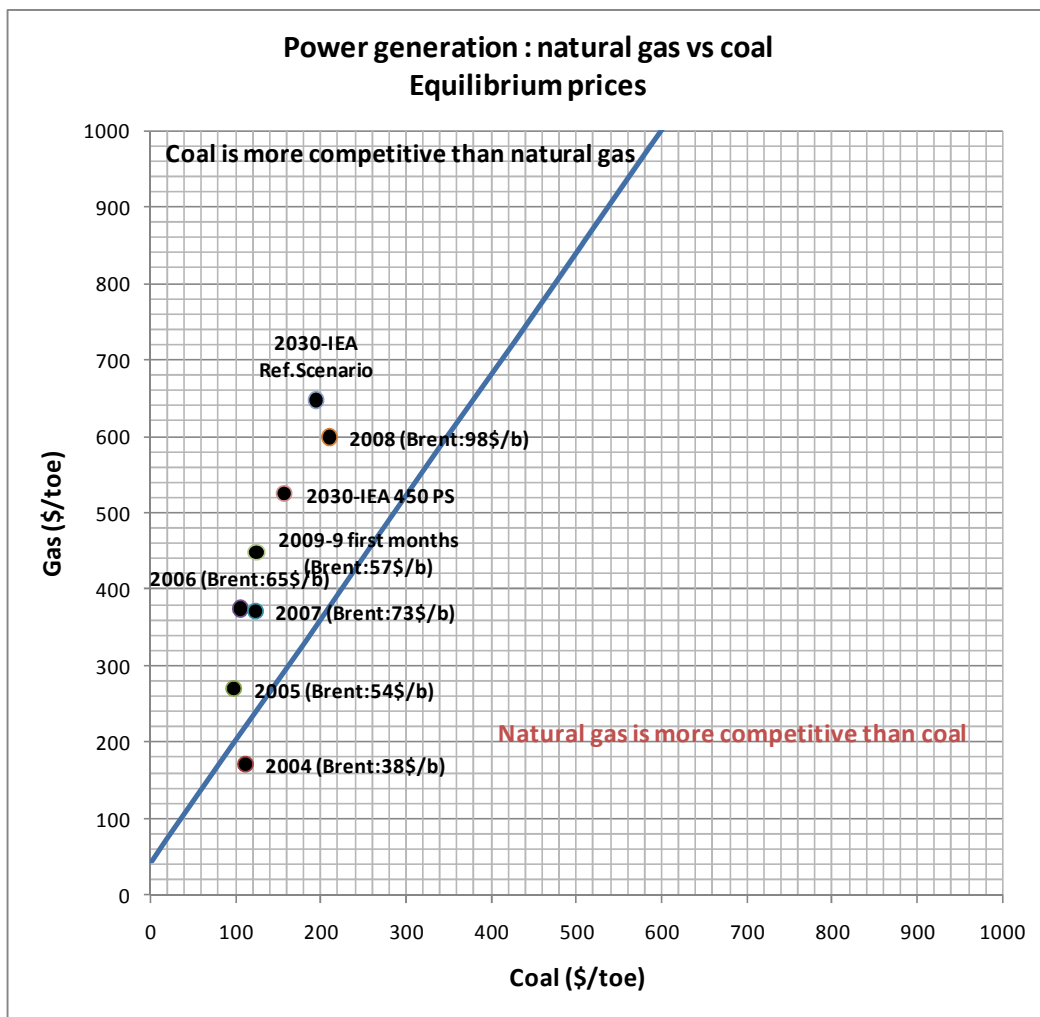

Source: IEA, Beicip-Franlab

Figure 4-12 Power generation: equilibrium prices (natural gas vs coal)

It is worth to note that, except in year 2004, coal is more competitive than natural gas for power production.

Finally, this is supposed to persist up to 2030 if the forecast prices of the IEA are confirmed for both Reference Scenario and 450 Policy Scenario.

Compared to wind + PSP, coal is the cheapest as far as its price is not higher than 200\$/toe (134\$/t for coal in Morocco or 114\$/t in FOB price).

Compared to wind + PSP, Natural gas is cheaper as far as its price is not higher than 367\$/toe (9.2\$/MBtu for natural gas in Morocco or 8 \$/MBtu in FOB price).

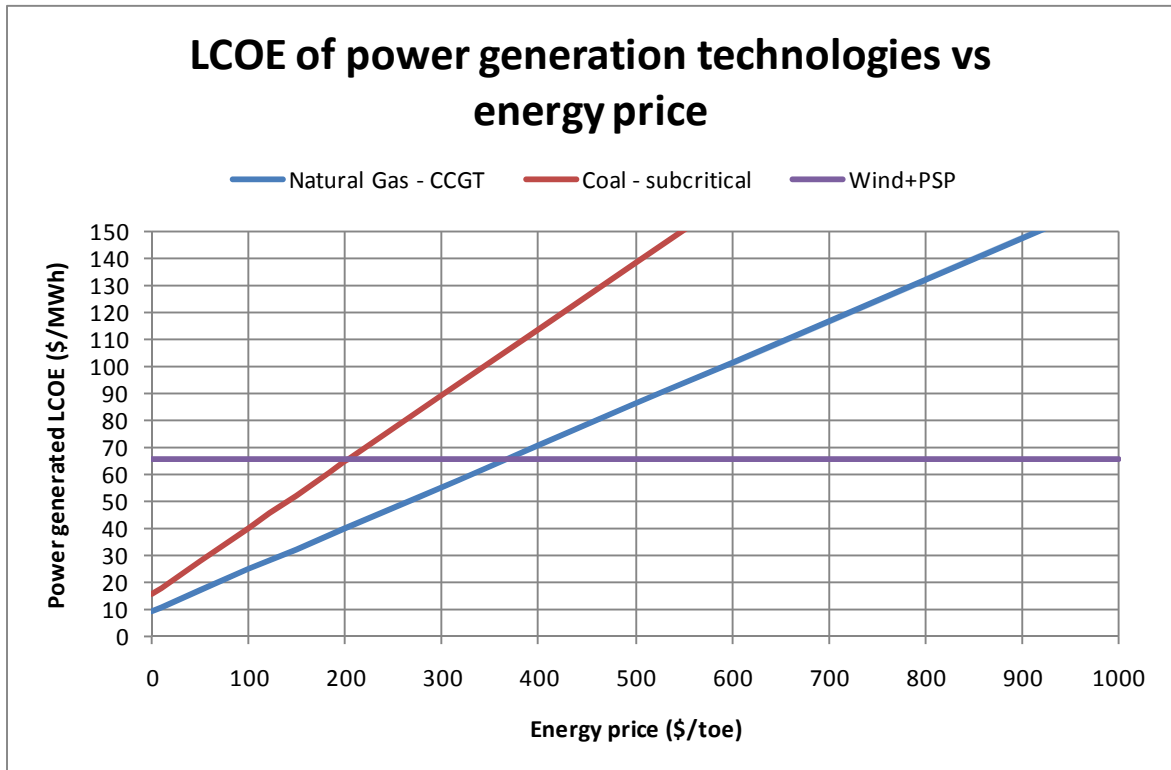

Source: IEA, Beicip-Franlab

Figure 4-13 Power generation: LCOE comparison

#### 4.1.6 Energy efficiency

Energy efficiency will be the key driver for developed countries to reduce their CO<sub>2</sub> emissions. The share of reduction obtained by energy efficiency can be up to 50% thanks to improvement in technologies but also to consumers more concerned about utilization of energy, means of transport and efficiency of housing insulation.

The Morocco target is a 15% reduction of its energy needs by 2030 compared to business as usual. Estimation of the potential gain in the different sector is given by MEMEE.

**Table 11 Split of the Moroccan target of energy efficiency**

Industry	48%
Transport	23%
Residential	19%
Tertiary	10%
Total	100%

Source: MEMEE

Gains for energy efficiency are very linked to Morocco policy of subsidies to petroleum products. The increase of their consumption in year 2008 compared to 2007 is an example of the weak consequence of subsidizing petroleum products consumption.

## 4.2 Evaluation of Morocco strategy

### 4.2.1 Criteria of evaluation

The Morocco strategy has been evaluated taking into account 4 criteria:

- Energy sustainable development
- Import dependency
- Cost of energy
- CO2 emissions

### 4.2.2 Definition of indicators for each criterion

For each criterion, Beicip-Franlab has defined an indicator.

#### 4.2.2.1 Energy sustainable development indicator

To assess the sustainability of the Moroccan energy mix, it is defined an energy sustainable development indicator for each energy as well as for energy efficiency. The defined values of this indicator are given on the below table for various types of energy.

**Table 12 Value of the energy sustainable development indicator**

Energy sustainable development	Renewable energies (wind, solar, biomass...)	Energy efficiency	Nuclear energy	Fossil energies (oil, gas, coal)
Indicator	100%	100%	0%	0%

The energy sustainable development indicator is defined as 100% for all EE and RE including sustainable biomass. Nuclear is not qualified as sustainable as uranium reserves exist in a limited quantity (from 25 to 80 years depending on the sources). The fossil energy are qualified as non sustainable due to their limited reserves, 42 years for oil, 60 years for gas and 122 years for coal as per BP Statistical Review 2009

The resulting indicator of the energy sustainable development of a given strategy is the weighted average based on TPES shares (including EE).

The Morocco strategy targets 15% of EE and 15% RE then its energy sustainable development indicator target is 30%.

#### 4.2.2.2 Import dependency indicator

The indicator used to evaluate the import dependency is the percentage of energy in the TPES that is imported in Morocco. Renewable energies are considered as local as well as nuclear (taking into account that uranium can be extracted from the Moroccan phosphate). Fossil energies are counted as foreign supply. The defined values of this indicator are given on the below table for various types of energy.

**Table 13 Value of the import dependency indicator**

Import dependency	Renewable energies (wind, solar, biomass...)	Nuclear energy	Fossil energies (oil, gas, coal)
Indicator	0%	0%	100%

The resulting indicator of the import dependency of a given strategy is the weighted average based on TPES shares (without EE).



#### 4.2.2.3 Cost of energy indicator

The cost of energy (COE) is calculated in \$/toe for all energy including energy efficiency.

For coal, natural gas, nuclear, wind, hydro and solar power, the cost of energy used is the levelized cost of energy (LCOE) that is the cost of generating power from this energy sources. The LCOE includes cost of investment as well as operating & maintenance (O&M) cost. It is calculated in \$/MWh of produced power and converted to \$/toe using MEMEE convention (1 TWh=0.260 Mtoe).

The convention of IEA (1 TWh=0.086 Mtoe) would give LCOE three times higher, however the resulting cost of energy for power is the same.

For petroleum products, the COE used is the CIF price in Morocco.

For energy efficiency, it has been assumed that up to 15% of energy saving, the average cost of these EE is equal to the lowest COE which means the LCOE for coal. We made this assumption because energy efficiency measures are difficult to assess in Morocco as no base line are defined for these measures which is mainly due to a lack of statistical data.

The resulting indicator of the cost of energy of a given strategy is the ratio in percentage of the COE weighted average based on TPES shares (including EE) to the Brent price.

##### 4.2.2.3.1 Price of oil, coal, gas and petroleum products

To conduct the assessment of Morocco strategy, two levels of Brent price are considered:

- 60 \$/bbl (a bit below the 5 past years average – 65 \$/bbl)
- 100 \$/bbl (a bit higher than the average price of 2008 – 98 \$/bbl)

Beicip-Franlab has used for its evaluation the average price ratios structure of the 5 past years instead of the IEA price forecasts.

Indeed, petroleum products prices are directly linked to the crude oil price. For instance, the ratio of price of a given petroleum product to Brent varies in a small range around an average value.

The same thing is also true for coal and natural gas prices ratio to crude oil.

**Table 14 Average energy FOB price ratio to Brent (2004 - 2008)**

	Average energy FOB price ratio Brent (2004-2008)
<b>Brent</b>	<b>1,00</b>
Natural gas (Europe market)	<b>0,62</b>
Butane	<b>1,04</b>
Gasoline U95	<b>1,21</b>
Gasoil 50ppm	<b>1,25</b>
FO SR 0.7%S	<b>0,78</b>
Fuel oil 3.5%S	<b>0,60</b>
Coal (South Africa)	<b>0,24</b>

Taking in account the current importation logistics and taxes cost given by Moroccan authorities through the last official petroleum products price structure, the CIF prices have been calculated.

Usual transport and unloading costs are considered to evaluate the CIF prices of natural gas, coal and uranium.

The resulting CIF prices are the following:

**Table 15 CIF prices (\$/toe) for two levels of Brent price (60 \$/bbl & 100 \$/bbl)**

CIF Price (\$/toe)	Brent @60 \$/bbl	Brent @100 \$/bbl
<b>Brent</b>	<b>450</b>	<b>750</b>
Natural gas	317	529
Propane	510	826
Butane	514	833
Gasoline U95	593	963
Gasoil 50ppm	612	994
FO SR 0.7%S for power	398	638
Fuel oil 3.5%S for power	317	502
Fuel oil 3.5%S	317	502
Coal	122	184
Uranium	15,4	15,4

Source: MEMEE, Beicip-Franlab

#### 4.2.2.3.2 Cost of generating power

The LCOE of power generated from fossil fuels are calculated based on the above CIF prices for fossil energies. It is given in \$/MWh electrical but also in \$/toe in order to evaluate the cost of future energy mix presented by MEMEE.

To assess the LCOE, an interest rate of 4% was considered. This figure is equal to “the real long-term government bond rate”<sup>1</sup>.

**Table 16 LCOE for the different power plant technologies**

Power plant technology	Capital cost	O&M cost	Efficiency	Capacity factor	Time for economical evaluation	Lifetime	Brent @ 60\$/bbl		Brent @ 100\$/bbl	
							LCOE		LCOE	
							\$/Mwh elec	\$/toe	\$/Mwh elec	\$/toe
Coal - subcritical	1200	24	35%	85%	20	40	45	183	61	248
Nuclear	3200	96	33%	85%	20	60	51	195	51	195
Gas (CCGT)	750	11	56%	85%	20	40	58	377	90	588
Biomass	2600	52	33%	85%	20	40	78	299	78	299
Hydro	1950	49		45%	20	60	50	192	50	192
Wind power (low pen.)	1650	35		35%	20	20	52	200	52	200
Wind power (high pen., incl PSP)	1950	45		35%	20	20	65	251	65	251
Thermal solar	2700	95		36%	20	40	95	365	95	365
Solar PV	3400	22		21%	20	20	152	583	152	583

\* Efficiency of 33% (1 MWh = 0.260 toe) is considered for hydro, wind power and solar as per MEMEE convention in order to calculate LCOE in \$/toe

Source: IEA, MEMEE, Beicip-Franlab

<sup>1</sup> In its « Pathways to a Low-Carbon Economy » report, McKinsey & Company considers this value as the « historical average for long-term bond rates » for governments.

With a Brent price at 60 \$/bbl, coal is the cheapest fuel for power production.

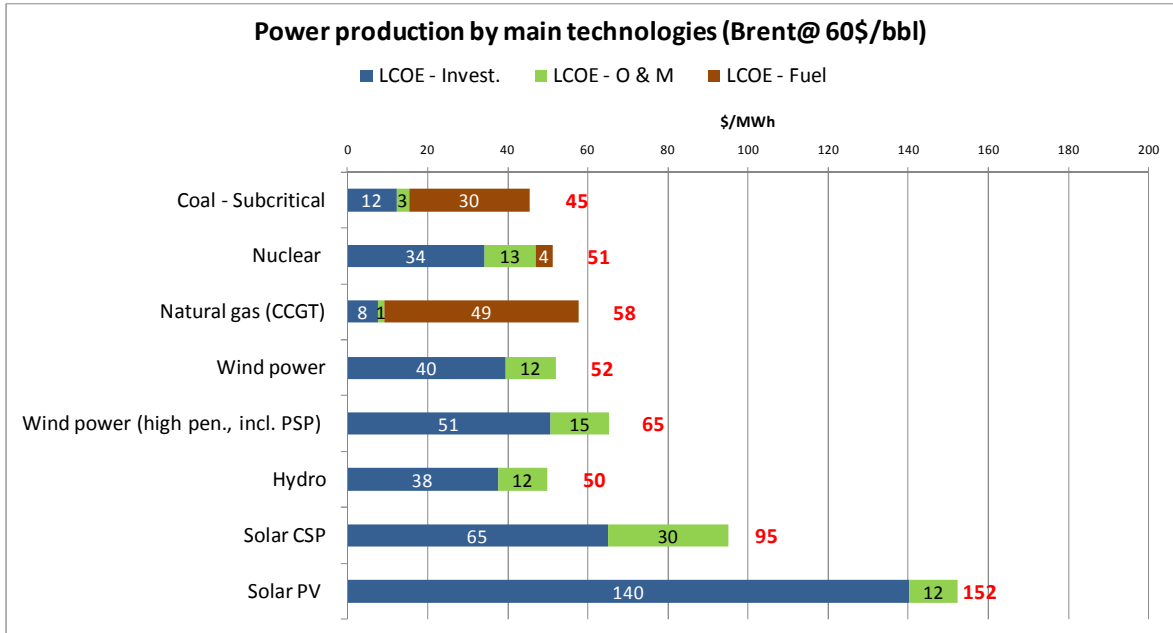

Source: IEA, MEMEE, Beicip-Franlab

Figure 4-14 LCOE breakdown per power generation technology (Brent @ 60\$/bbl)

At 100\$/bbl low penetration wind is competitive in Morocco and high penetration wind is almost as competitive as coal.

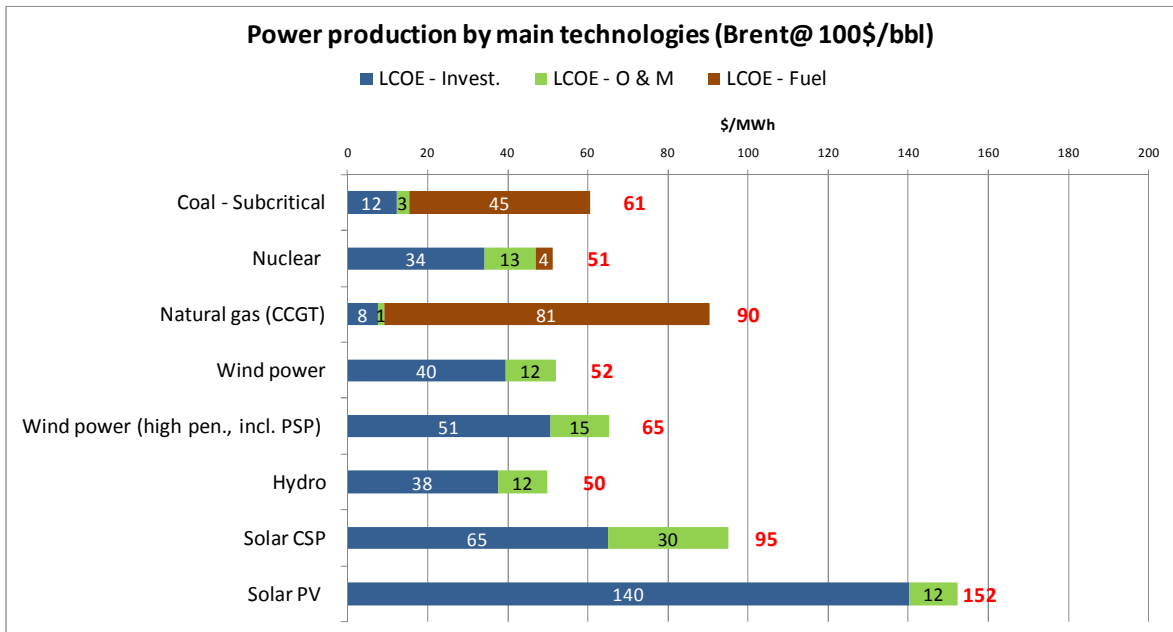

Source: IEA, MEMEE, Beicip-Franlab

Figure 4-15 LCOE breakdown per power generation technology (Brent @ 100\$/bbl)

#### 4.2.2.4 CO2 emissions indicator

Quantities of emitted CO<sub>2</sub> are directly calculated from the TPES considering the respective CO<sub>2</sub> emission intensity of each energy.

It is considered the emission intensities given by the Intergovernmental Panel of Climate Change (IPCC) in its 2006 publication.

**Table 17 CO<sub>2</sub> emission intensity of the different types of energy**

CO <sub>2</sub> emissions	RE (wind, solar, biomass...)	Hydro/ Nuclear	Natural gas	LPG	Crude oil	Fuel oil	Gasoil/ Diesel	Coal
Emission intensity (tCO <sub>2</sub> /toe)	0	0	2.35	2.64	3.07	3.24	3.10	3.96

Source: IPCC 2006

To evaluate the overall CO<sub>2</sub> emission gain, a BAU scenario is defined as a scenario without EE and without new RE. This means that on a pure economical point of view all RE used to produce power in the Morocco strategy are replaced by coal which the lowest cost of energy.

The main characteristics of this BAU scenario are presented here below.

**Table 18 Characteristics of the BAU scenario**

	2006	2012	2020	2030
EE	0.0%	0.0%	0.0%	0.0%
Hydro	1.6%	1.2%	0.8%	0.5%
Wind	0.1%	0.1%	0.1%	0.04%
Solar	0.0%	0.0%	0.0%	0.0%
Biomass (sust.)	0.0%	0.0%	0.0%	0.0%
Nuclear	0.0%	0.0%	0.0%	0.0%
Gas	3.7%	5.0%	3.4%	2.1%
Oil & petroleum prod.	63.4%	56.5%	42.9%	38.7%
Coal	27.9%	34.7%	51.2%	57.7%
Biomass (unsust.)	3.4%	2.5%	1.7%	1.0%
Total	100.0%	100.0%	100.0%	100.0%
Total RE	2%	1%	1%	1%
TPES Mtoe/y	13.4	18.0	26.6	43.3
CO <sub>2</sub> emission Mt/y	41.6	57.4	90.2	151.3

Source: MEMEE

The indicator of the CO<sub>2</sub> emissions of a given strategy is the ratio in percentage of CO<sub>2</sub> emitted to the BAU scenario.

### 4.2.3 Results of the evaluation of Morocco strategy

In the absence of strategy, the BAU scenario gives the following trend.

**Table 19 Results of the evaluation of the BAU scenario**

Indicators	2006	2012	2020	2030
Energy sustainable development %	1.7	1.3	0.8	0.5
Import dependency %	95.0	96.2	97.5	98.4
COE (% Brent @ 60 \$/bbl)	92.6	87.7	76.3	72.4
CO2 (% of BAU)	100.0	100.0	100.0	100.0

The benefit of Morocco strategy is given here below for the four selected criteria. It is interesting noting that the cost of energy will be slightly decreased thanks to energy efficiency which limits the use of expensive petroleum products. It is worth to note also that the Moroccan strategy will allow decreasing the import dependency in 2030 from 98% to 76%.

**Table 20 Results of the evaluation of the Moroccan strategy**

Indicators	2006	2012	2020	2030
Energy sustainable development %	1.7	12.0	19.0	30.0
Import dependency %	95.0	89.1	87.1	76.2
COE (% Brent @ 60 \$/bbl)	92.6	86.2	74.4	69.9
CO2 (% of BAU)	100.0	87.4	79.9	63.4

The evolution over time of the 4 indicators is given in the graph below. It shows that Morocco strategy is well oriented.

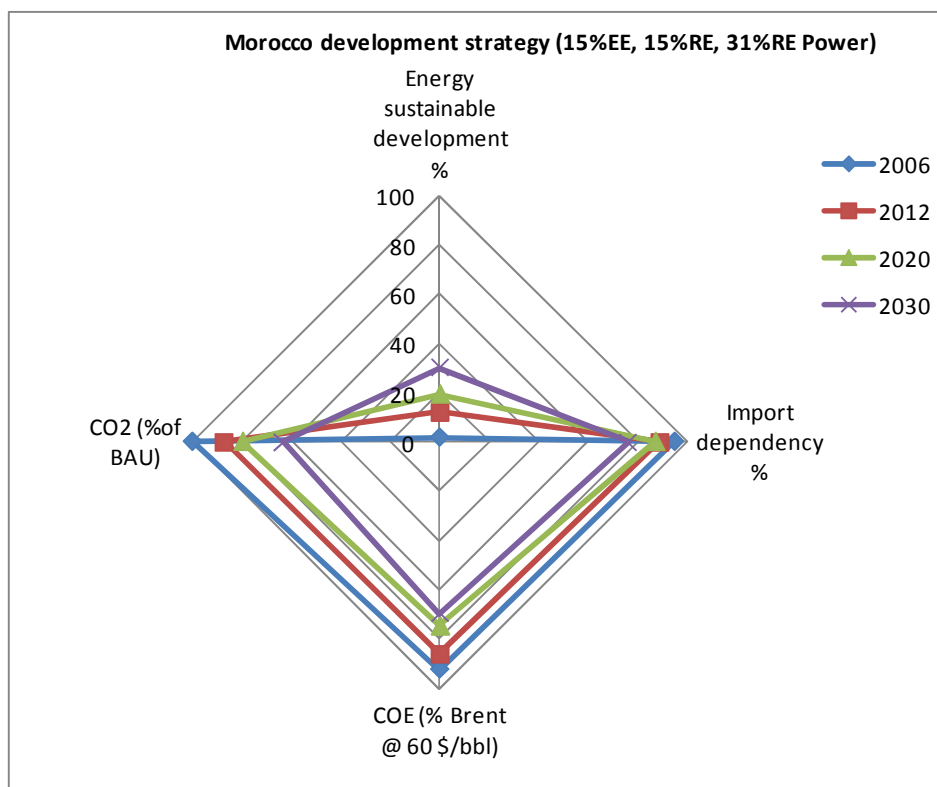

Source: Beicip-Franlab

**Figure 4-16 Morocco development strategy evaluation**

In comparison with the BAU, the Moroccan strategy reduced the CO2 emissions mainly through 5 wedges (defined by Socolow as abatement means as per reference n<sup>o</sup>7) which correspond to the introduction of wind power, solar energy, biomass (sustainable), nuclear and energy efficiency in the energy mix.

In addition to these 5 wedges, a sixth wedge represents the remaining potential for switching coal to gas.

The table hereafter gives the respective CO2 emissions abatement for each of those wedges.

**Table 21 Morocco development strategy: CO2 abatement**

	1990	2000	2006	2012	2020	2030	CO2 reduction to BAU in 2030			
	MtCO2/y	Mt/y	Mt/y	Mt/y	Mt/y	Mt/y	per wedge (Mt/y)	per wedge (%)	cumulated (Mt/y)	cumulated (%)
BAU	21.0	31.0	41.6	57.4	90.2	151.3	0.00	0%		
Wind			41.6	52.6	82.9	132.6	-18.70	-12%	-18.70	-12%
Solar				52.6	80.6	127.8	-4.76	-3%	-23.46	-16%
Biomass (sust)					80.6	126.5	-1.36	-1%	-24.82	-16%
Nuclear					80.6	119.3	-7.18	-5%	-32.00	-21%
EE			41.6	50.2	72.1	96.0	-23.31	-15%	-55.32	-37%
Coal to gas				50.2	59.5	75.6	-20.36	-13%	-75.67	-50%

Through the Moroccan energy strategy, the amount of emitted CO2 in 2030 will reach 96 Mt instead of 151 Mt as it would have been in the BAU scenario: that means a total CO2 abatement of 37%.

This is better shown in the following abatement curve

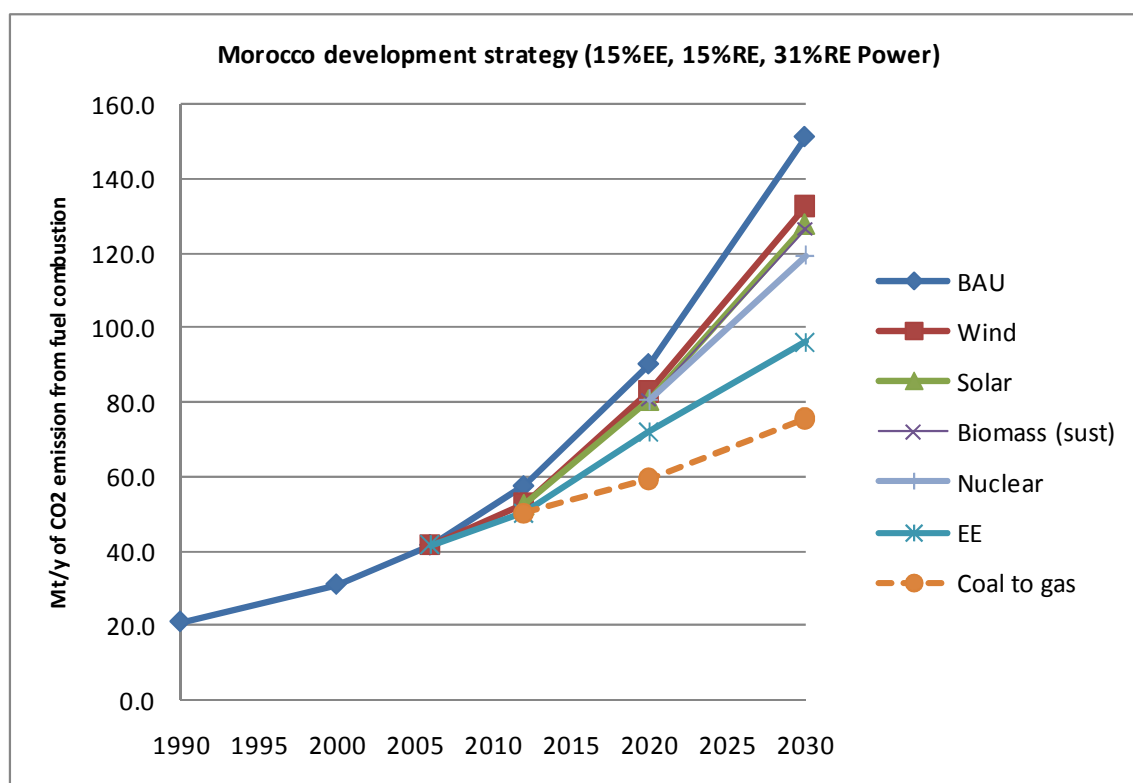

Source: Beicip-Franlab

**Figure 4-17 Morocco development strategy: abatement curve**

The main contributors of the 37% gain to BAU scenario are the wind energy and the energy efficiency gain.

The option to go to gas after the already planned coal power plant (i.e. after 2015) allows withdrawing an additional of 13% the CO<sub>2</sub> emissions.

#### 4.2.4 Cost of CO2 abatement

For each measure reducing the CO2 emissions, Beicip-Franlab has calculated the CO2 abatement cost. It should be understood as the additional cost relative to the BAU scenario divided by the total amount of avoided CO2 emissions thanks to this measure.

The CO2 abatement cost curve gives the following result:

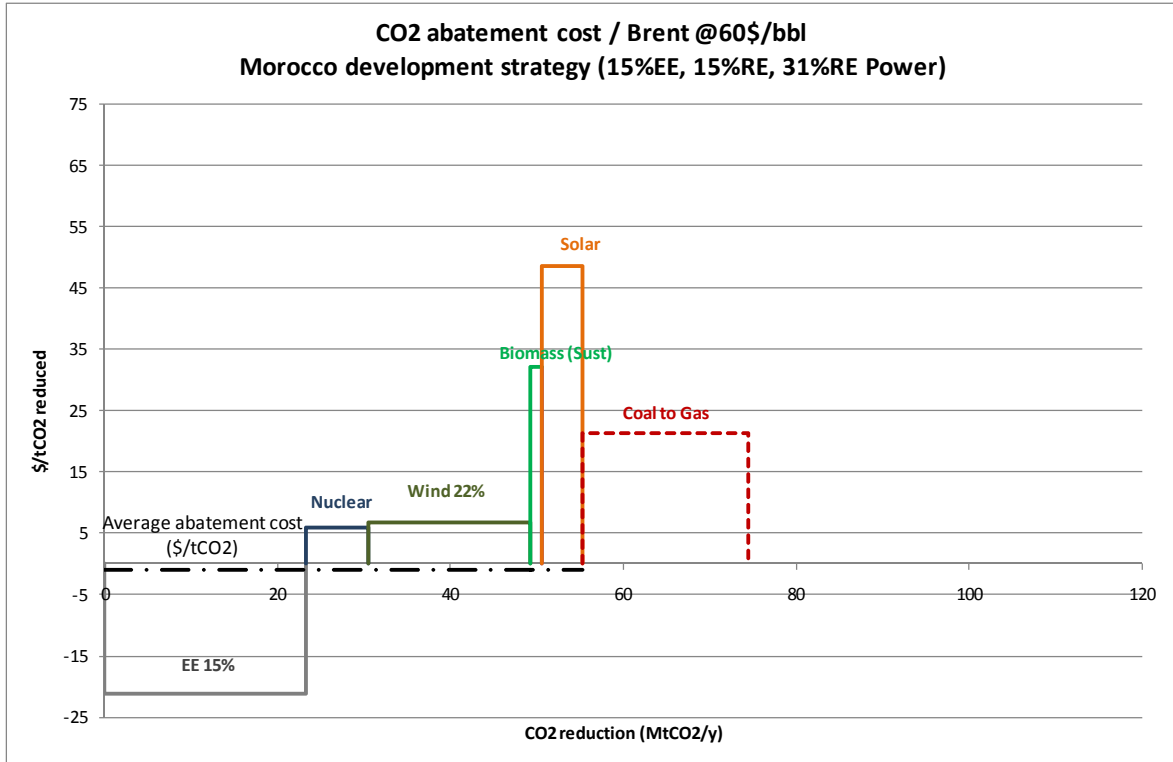

Source: Beicip-Franlab

**Figure 4-18 Morocco development strategy: CO2 abatement cost**

EE, nuclear and wind appear to be the most economic and efficient ways to decrease CO2 emissions. The average abatement cost (dotted line in black) is slightly negative, meaning that Morocco strategy is less costly than BAU scenario.



### 4.3 Measures taken by Morocco to reach the targets

Morocco has developed a PNAP (Plan National d'Actions Prioritaires) which covers the period 2008-2015. This national program aims to define the strategy of Morocco mostly in term of power for the next coming years.

The PNAP contains measures on demand and supply sides.

On the supply side, a large equipment plan with new power production capacities is defined for ONE. The following sketch presents the planning of this measure.

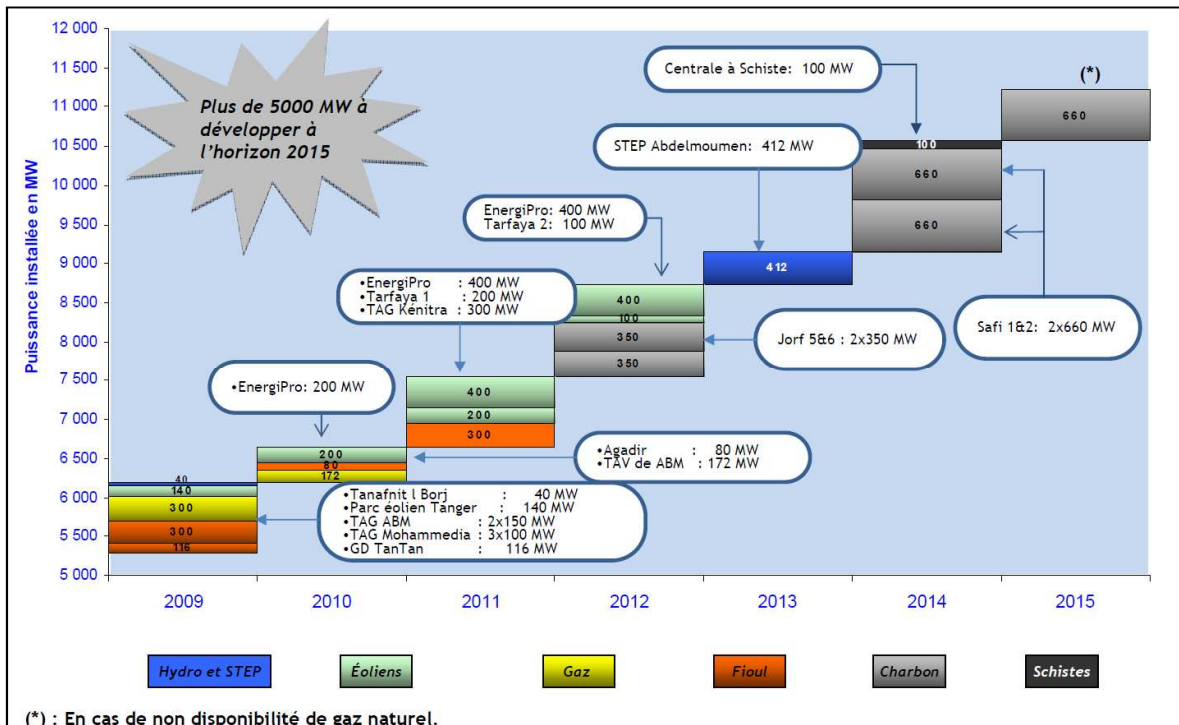

Source: ONE

**Figure 4-19 Morocco power plants equipment plan (2009-2015)**

After this program, Morocco will double its 2008 power production capacity, with an important increase of renewable energy (18.6% of total installed capacity in 2015).

This is quite in line with the energy strategy presented and analysed in the sections 4.1 and 4.2 where we had 18% of RE in power production in 2012 and 20% in 2020.

This increase of power production capacities will be supported by:

- the construction of new high voltage lines linking Morocco to its neighbours (Spain and Algeria) in order to increase the current exchanging capacities
- the extension of the national distribution network in order to connect new production sites and to better cover the country.

A view of the existing network and the main projects of power lines is presented on the map hereafter.

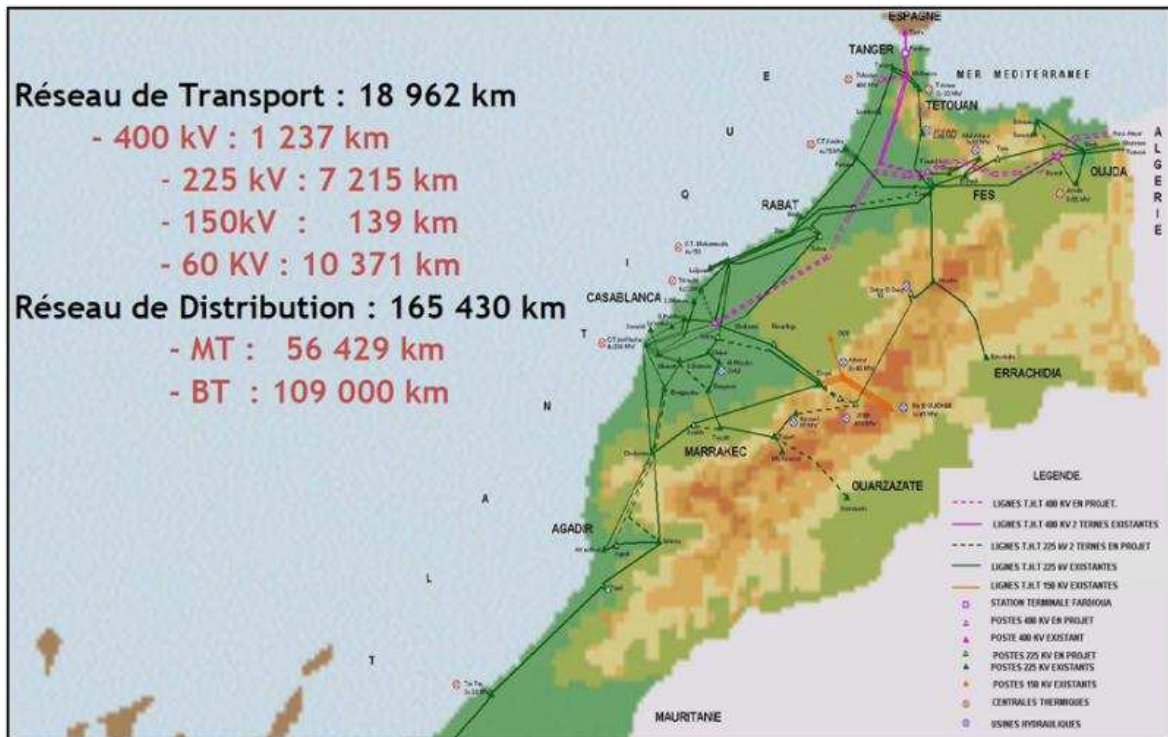

Source: ONE

**Figure 4-20 Morocco power transport and distribution network**

On demand side, lot of measures are taken:

- Incentives power prices to encourage people/manufacturers to reduce their consumption during peak hours
- Introduction of a new time zone (GMT+1) during summer months : GMT +1 from June to August and GMT from September to May
- Subsidizing for the replacement of 22 millions of incandescent bulbs by compact fluorescent lamp (CFL) in residential and administration sectors by 2012
- Diversification of energy sources :
  - In residential and commercial sector with sub-programs like PROMASOL (which plans to install 440000 m<sup>2</sup> of solar water heaters by 2012 and 3000000 m<sup>2</sup> by 2030).
  - In industry sector, with sub-programs like ENERGIPRO that gives the opportunity to manufacturers to produce their own renewable power through wind turbines. Incentives feed-in tariffs are proposed to encourage this type of investment.
- National energy efficiency program in building, industries and transport sectors
- Introduction of a building regulation to impose a certain level of thermal insulation for new building projects.

Only one measure of the PNAP (measure 14) has the objective of increasing the efficiency of petroleum product consumption. This measure is not enough quantified in the PNAP to check its consistency with the energy strategy.

## 5 PROPOSED HIGH EE&RE SCENARIO TO STABILISE MOROCCO ENERGY CO2 EMISSIONS

### 5.1 Targets of the scenario

The Morocco program is well oriented and ambitious. The objective of this paragraph is to check whether it could be reasonably more ambitious with the doubling of the targets of renewable energy and energy efficiency set by MEMEE.

This means 30 % of renewable energy, 30% of energy efficiency. The renewable penetration in the produced power will be 70% instead of 31% and the wind energy penetration will be 53% instead of 22 %. Our target of renewable energy is kept with the same proportion of wind, solar and biomass as in the MEMEE strategy.

This program should be developed if Morocco intends to be a clean energy provider to Europe (see paragraph 6).

### 5.2 Potential measures to reach these targets

#### 5.2.1 Renewable energy

##### 5.2.1.1 Hydropower and pumping storage plant

Increased RE production means increased need for PSP. In this respect, the large number of dams and their water capacity which have been designed to cope with several dry years give the opportunity to Morocco to build numerous pumping storage plants.

To make a screening analysis we can define the required volume of the upper and lower storages of a pumping storage plant of 400MW. To handle peak power production, storage of around 6 hours is sufficient and the present PSP of Afourer and the future one of Abdelmoumen are using this storage time.

For wind generation the data presented for Tarfaya shows that 32 hours is the maximum time with no wind power production. Looking to the results of Germany and USA, the most important wind energy producer, it appears that lack of wind is lower than two days (see below graph).

## Load and Wind on BPA System

December 24-31, 2007 (Total Installed Wind of 1,300 MW)

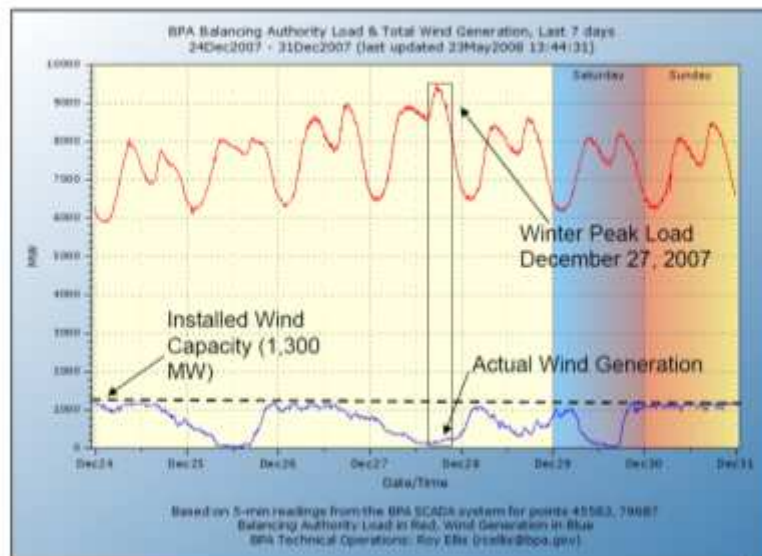

Courtesy of Bonneville Power Administration

**Figure 5-1 Example of wind power production and power system load**

Starting from these observations we state that a 48 hours storage will be a good criterion to cope with wind variability. This storage time is also the one of the biggest PSP of France: it allows storing power during the weekend when consumption is less due to lower industry and commercial needs.

The second criterion to design a water storage of a PSP is the available difference of elevation between the upper and lower storage. High height will reduce storage requirement in proportion and also reduce the cost of the PSP. With present turbine technology height could be within 1000 m. The available height is site dependant and it is rare to have such height. The two PSPs of Morocco are using a height of 600 m. Many PSP in the world have lower height and PSP can still be very economical with height of 300m.

The required water volume to produce 400 MW during 48 hours with a height of 300 m is 26Mm<sup>3</sup> with a yield of 90% for the turbines.

These criteria allow preselecting 35 dams in Morocco which can be used to support a PSP with such requirement. The list is given in the following table. The percent of reserves needed to produce 400 MW during 48 hours under 300 m height is given in the right column.

**Table 22 List of 35 dams able to support pumping storage plant (PSP)**

	Power (MW)	Name	capacity (Mm3)	reserves (Mm3)	Basin	% of reserves needed for the PSP storage
1	248	AL WAHDA	3712	2934	SEBOU	1%
2	128	AL MASSIRA	2657	1965	OUM ER RBIA	1%
3	229	BINE EL OUIDANE	1243	1135	OUM ER RBIA	2%
4	41	IDRISS 1er	1130	1040	SEBOU	3%
5		SIDI MOHAMED BEN ABDALLAH	975	855	BOU REGREG	3%
6	36	OUED EL MAKHAZINE	699	644	NORD	4%
7	92	AHMED EL HANSALI	744	556	OUM ER RBIA	5%
8	10	MANSOUR EDDAHBI	445	445	SUD ATLAS	6%
9		HASSAN II	404	380	MOULOUYA	7%
10		HASSAN ADDAKHIL	321	316	SUD ATLAS	8%
11	24	MOHAMED V	327	291	MOULOUYA	9%
12		Barrage 9 AVRIL 1947	301	252	NORD	10%
13	67	HASSAN 1er	244	238	OUM ER RBIA	11%
14		EL KANSERA	221	164	SEBOU	16%
15		SIDI CHAHED	161	160	SEBOU	16%
16	24	MOULAY YOUSSEF	150	145	OUM ER RBIA	18%
17		ASFALOU	307	144	SEBOU	18%
18		YOUSSEF BEN TACHFINE	302	141	SOUSS-MASSA	19%
19		BARRAGE SUR OUED ZA	103	103		25%
20		AOULOZ	96	96	SOUSS-MASSA	27%
21		MOULAY ABDALLAH	103	88	SOUSS-MASSA	30%
22		SAQUIA EL HAMRA	110	88	SUD ATLAS	30%
23		ABDELMOUMEN	201	67	SOUSS-MASSA	39%
24		YAAKOUB MANSOUR	70	64		41%
25		SAHLA	62	62	SEBOU	42%
26	240	ALLAL EL FASSI	64	54	SEBOU	48%
27		TAMESNA	56	50		52%
28		LALLA TAKERKOUST	54	50	TENSIFT	52%
29		MOKHTAR SOUSSI	49	49	SOUSS-MASSA	54%
30		BOUHOUDA	55	49	SEBOU	54%
31		GARDE DU SEBOU	40	39	SEBOU	66%
32		SMIR	41	37	NORD	71%
33		BAB LOUTA	35	34	SEBOU	77%
34		MY HASSAN BEN AL MAHDI	32	30		88%
35		IBN BATOUTA	33	28	NORD	94%

Source: Secrétariat d'état chargé de l'eau (Morocco), ONE, Beicip-Franlab

From these 35 dams, 11 are already equipped with power production and linked to the grid. The dam of Bine El Ouidane, linked to the existing PSP of Afourer, and the dam of Abdelmoumen are in the list which means that an increase of their upper reservoir will make them suitable for long storage to store wind energy.

As a conclusion, in a mountainous country such as Morocco with a huge knowledge of hydro civil works, potential of PSP should be there. On top of that the north region of Morocco provides the Rif Mountains which are very close to the Mediterranean Sea and a PSP with sea water can be done with some additional investment for corrosion issue. This type of PSP is not limited with water availability.

The feasibility of such a PSP using sea water is already proved in Okinawa (Japan). The following picture shows a bird's-eye view of this seawater PSP using the sea as lower reservoir (installed power capacity: 30 MW).



**Figure 5-2 Bird's-eye view of a seawater PSP in Okinawa (Japan)**

To allow high wind penetration, a certain quantity of PSP should be added to the network. To determine the required PSP needs, the full network should be simulated taking in account demand scenario, wind atlas, accuracy of wind forecast, interconnection of the grid, and etc. This simulation will be required to optimize the investment in the power sector. However to assess feasibility of high wind penetration we can make a very conservative calculation with an average capacity factor of 40 % for wind energy and 40% of installed power PSP related to installed wind energy. This means that for 1000 MW of installed wind energy we add 400MW of PSP, therefore in any case 400 MW of power can be supplied to the grid and if all installed 1000MW wind mills are producing at their maximum capacity, only 20% of the power will have to be curtailed from the grid. This calculation is very conservative as in 48 hours of PSP storage, the base load thermal plant have ample time to deduce or increase their load or stop or start one of their module. Also if wind farms are located across Morocco with different wind regimes, probability to have a shortage or excess of wind is decreasing sharply.

With this system of PSP designed for 40% of wind capacity and with 48 hours storage the LCOE of wind energy is increased from 52 \$/MW to 65 \$/MW but wind penetration ratio is not an issue any more.

The same strategy has been selected by Spain in order to allow a wind penetration of 40% by 2020. A major project is under construction and it will increase the capacity of La Muela PSP from 635 MW currently to 1480 MW in 2010. The following picture gives a view of the existing PSP including the dam that is used as lower reservoir.



**Figure 5-3 Bird's-eye view of La Muela PSP (Spain)**

In Morocco, some additional power capacity may be gained from the existing dams by analyzing carefully the other reasons than lack of rains which explain their very low capacity factor such as sediment disposition and lack of lower reservoir to disconnect irrigation from power production. Improvement may be gained with limited investment and it can help the wind penetration. The hydro power management is the key asset of Morocco to allow deep wind penetration.

### 5.2.1.2 Wind

Accordingly to the previous calculation (see section 4.1.1.2), doubling the wind capacity target can be met. This means 11000 MW of installed wind energy by 2030 or 500 MW per year up to 2030.

The following graph shows the share of wind power in the Moroccan power production through this proposed scenario.

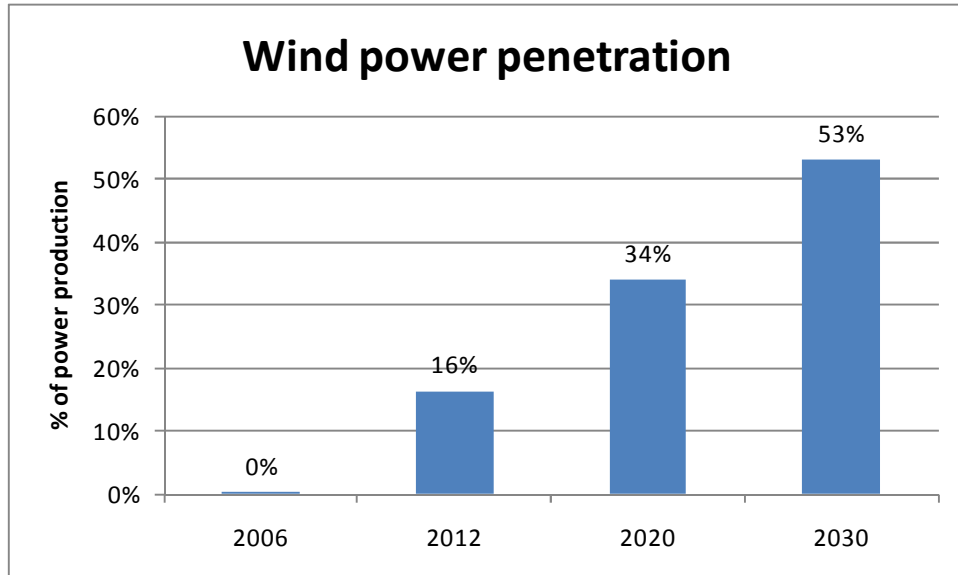

**Figure 5-4 High EE and RE scenario: wind power penetration**

A PSP of 400 MW should be added every 2 years, although the learning curve relating to wind energy management may show that this requirement can be decreased.



### 5.2.1.3 Solar

For solar energy, production is easier to predict and quite useful during the day to answer to the demand. The peak demand of the evening will be supplied by a PSP or by thermal storage with melted salts as shown in the following figure. This configuration has been chosen in Spain for Andasol1 which came into operation in December 2008.

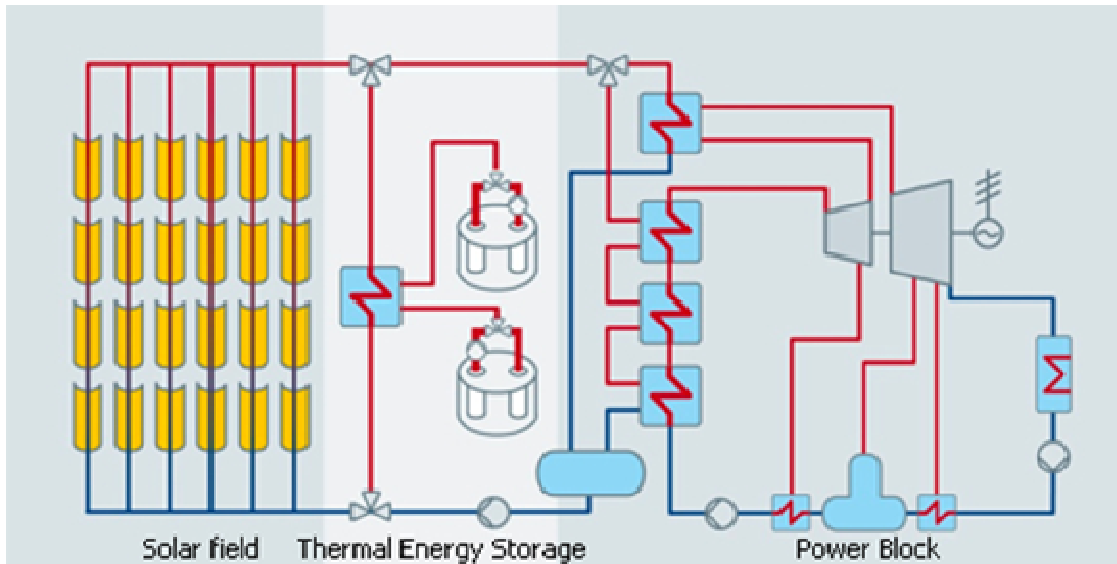
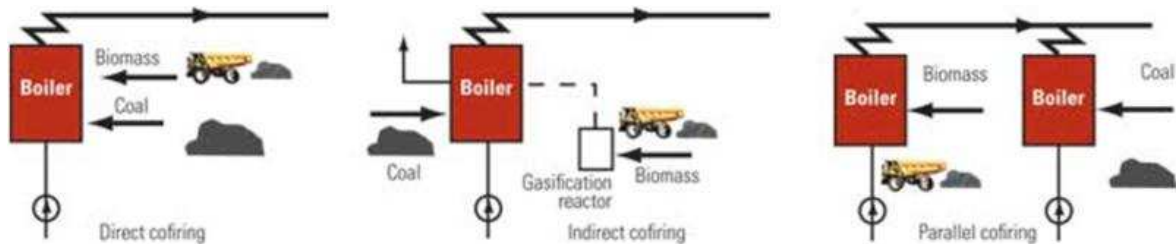

Figure 5-5 Andasol 1 plant scheme (CSP with storage)

#### 5.2.1.4 Biomass

As a result of high renewable energy penetration and high energy efficiency on demand side, the coal power plants built during the period 2012 and 2020 are underutilized. In this scenario the biomass target of 400MW can be achieved at low cost by co-firing biomass in the existing coal power plant.

The following sketch presents the 3 possible options of co-firing biomass in coal power plants:



Source: National Renewable Energy Laboratory (USA)

**Figure 5-6 Biomass and coal co-firing power plant**

The first option is the lowest investment required one, only minor adaptations are necessary and up to 5 % biomass in heat value can be burnt.

The second option adds a gasifier to the plant and allows burning any kind of biomass.

The third option adds a complete boiler; it gives the highest capital investment. In a coal power plant like the planned one of Safi with three modules of 660 MW each, one of the boilers can be retrofitted for biomass firing meeting easily the Morocco target of 400MW of electricity produced by biomass.

The second and third configurations allow also segregating biomass ashes from coal ashes. Biomass ashes can be recovered as natural fertilizer.

The drawback of biomass is the volume it requires to produce the same heat than coal. Using rule of thumb, storage of ten times more volume is required for biomass. Therefore it is recommended to provide enough land space to manage the required volume of biomass.

On a yield bases if power is used in an electrical vehicle, the overall yield of the biomass is 40% for the power plant and 70% for the electrical vehicles which means an overall efficiency of 30%. Among all envisaged second generation biofuel technologies none of them can theoretically achieve a better overall yield than 15%.

#### 5.2.2 Nuclear

The target of one reactor of 1000MW is unchanged.

#### 5.2.3 Gas

The gas supply is kept unchanged; however, as wind penetration is high there is no need of new thermal power plant on gas for the period 2020-2030. In the period 2012-2020, it has been considered that the power plants already decided by MEMEE are not questioned.

Apart from the power sector, the benefit of introducing gas will be to replace butane usage. In this case, the gain on CO<sub>2</sub> emission is low, but the COE of the energy mix will be decreased.

### 5.2.4 Petroleum products

With a target of 30% of EE instead of 15% petroleum products demand is reduced in proportion.

### 5.2.5 Coal

For coal power plant we considered that the one added to the network up to 2020 will need to be at the highest possible yield allowed by technology and with a maximum flexibility range associated with very small efficiency losses. The supercritical technology allows reaching these two targets. On top of that the design should take into account the gradual introduction of biomass up to a ratio of 33% for last built power plants.

The graph hereafter shows the benefit of investing in high yield power plant coal for the future Safi plant compared to the existing coal power plants of Morocco.

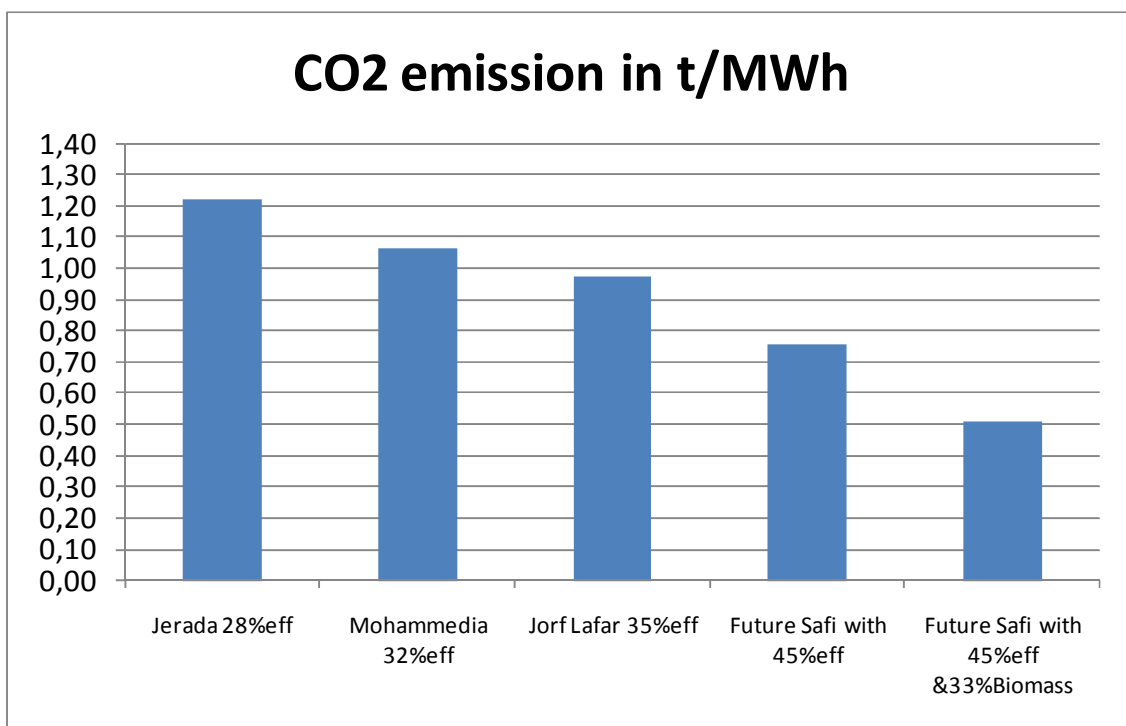

Source: ONE, Beicip-Franlab

**Figure 5-7 CO2 emissions of Moroccan coal power plants**

Addition of new high efficiency and high RE penetration will lead to closure of old coal power plant or limit their usage as reserves power plant during summer time. The addition of 33% of biomass to the future Safi coal power plant will decrease by one third CO2 emission.

Even if wind is good and stable, possible variability has to be taken into account.

Therefore new thermal power plant GCC or coal should be designed with maximum flexibility to cope with wind instability.

For this feature, new supercritical coal power plants show some benefits in term of yield losses at low loads as it is indicated in the following graph.

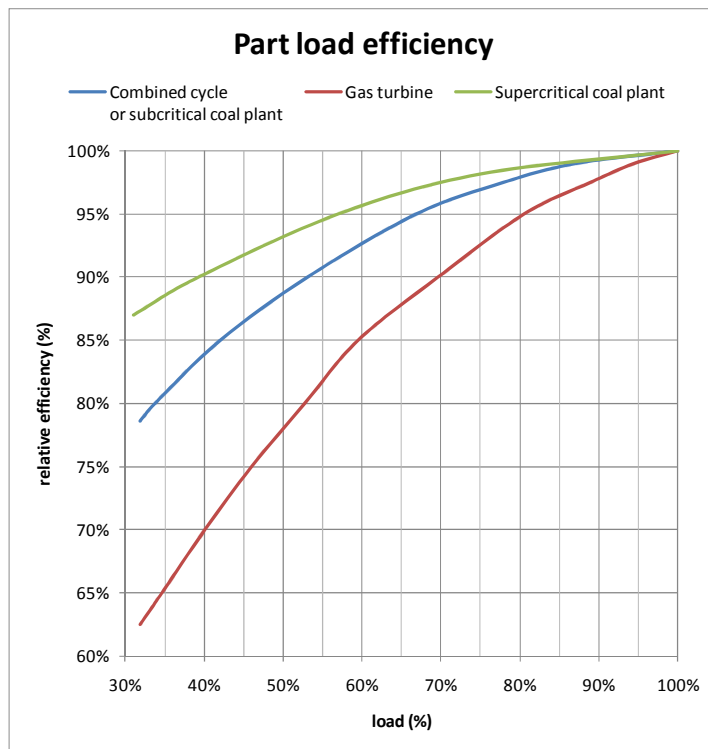

Source: CCG and steam turbine power plants, 1999, 2<sup>nd</sup> Edition, Rolf Kehlhofer

**Figure 5-8 Power plant technologies part load efficiency**

### 5.2.6 Energy efficiency

The 30% efficiency target can only be achieved if all measures are taken such as :

- Modifying consumer behaviour toward the use of public transportation, low consumption electrical devices, low consumption car,
- optimizing train and boat usage for good transportation,
- and also maximizing cogeneration in the industry as well as changing processes to new ones.

For each of these improvements, the gain is potentially much higher than 30%. To reach a sufficient level of consumer awareness, stakeholders have to set constraint on energy efficiency goal. A carbon tax could be an efficient and logical system to apply. By contrast, poor efficiency gain will be obtained if fossil energies are still subsidized.

In the scenario of 30% efficiency, newly built efficient transportation options are foreseen. The transportation sector gives the highest CO<sub>2</sub> emissions and will not benefit from the gain made in the power sector.

The graph here below shows improvement on the famous Prius hybrid car which was at its launch 30% lower in consumption than comparable car at that time. Since 1997 with two new versions the additional gain is 25% more. Conventional gasoline and diesel cars consumptions have been also improved by 25% in the past 10 years. By 2020 new small cars will be under the level of 60g/km.

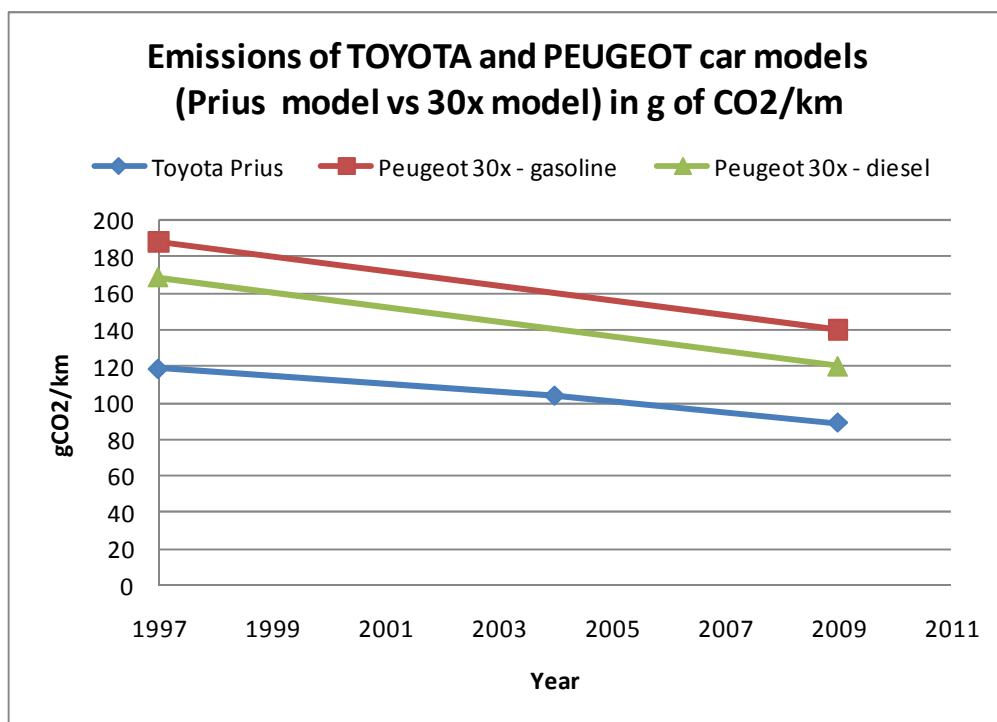

Source: TOYOTA and PEUGEOT

**Figure 5-9 Toyota Prius and Peugeot 30x CO<sub>2</sub> emissions evolution**

For trucks the gain is less, new trucks consume from 10 to 15% less than ones of ten years old. However with the considerable weight of the goods transportation, which is half of transportation sector, it is worth to promote replacement of all trucks.

Last but not least, transportation mode can be changed. Then, the resulting gain can be huge as a tramway or a bus rapid transit system. The World Bank calculated a gain of 0.16 Mtoe/y with a BRT system in Casablanca meaning a saving of 0.51 MtCO<sub>2</sub>/y. The BRT system is quicker to implement and lower in investment than a tramway for a comparable gain. It can be used for middle size town of Morocco which cannot afford a tramway system.

Here below, a picture of Bogota BRT.



Figure 5-10 Picture of the bus rapid transit of Bogota

### 5.3 Deep electrification of Morocco

The emission intensity of the power sector is substantially decreased due to the high RE penetration, keeping gas and nuclear share unchanged.

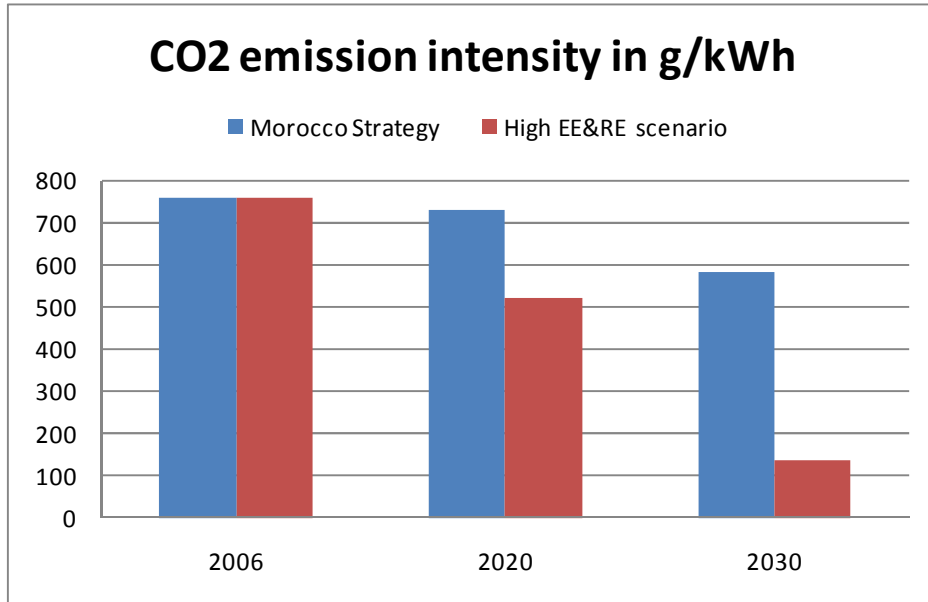

Source: MEMEE, Beicip-Franlab

**Figure 5-11 Comparison of the emission intensity of electricity production**

In the high EE&RE scenario, the emission intensity of electricity is much less than 202g/kWh in 2030, which is the emission intensity of gas when it is used in final energy utilization with an efficiency of 100%.

This means that any usage of a fossil fuel for space heating, cooking, and water heating can be replaced by electricity with an overall carbon emission gain. At that level of emission intensity, electricity can replace butane in all its applications.

The following table shows the breakeven electricity CO2 emission intensity to switch from fossil fuels applications to electricity.

**Table 23 Breakeven power emission intensity**

	Fossil fuels emissions	Yield of useful energy from fossil fuels	Yield of useful energy from electricity	Max. electricity CO2 intensity to switch from fossil to power
	g/kWth			gCO2/kWe
Space heating-boiler with condensation (Natural gas)	202	100%	100%	202
Space heating-boiler with condensation (Butane)	227	100%	100%	227
Space heating- heat pump	0	COP=4	100%	800
Cooking (Natural gas)	202	40%	85%	429
Cooking (Butane)	227	40%	85%	482
Cars (Diesel)	267	25%	70%	748

NB: COP = coefficient of performance

In the future, with the availability of plug-in hybrid cars and electrical vehicles, gains on CO2 emissions can be very significant as Morocco produces a very low emission intensity power.



### 5.4 Evaluation of the high EE&RE scenario

The same four indicators than for Moroccan strategy are used to assess this high EE and RE scenario.

In addition, for energy efficiency, it has been assumed that from 15% to 30%of energy saving, the average cost of these EE is equal two times the LCOE for coal. Again, we made this assumption because energy efficiency measures are difficult to assess in Morocco.

The targets of 30% of EE and 30% of RE is equivalent to an energy sustainable development indicator of 60% in 2030 by definition of this indicator.

The values for the 4 indicators defined by Beicip-Franlab are shown on the following table for the period 2006-2030.

**Table 24 Results of the evaluation of the high EE and RE scenario**

Indicators	2006	2012	2020	2030
Energy sustainable development %	1.7	16.5	38.8	60.0
Import dependency %	95.0	88.5	73.3	49.7
COE (% Brent @ 60 \$/bbl)	92.6	86.3	76.9	74.3
CO2 (%of BAU)	100.0	82.5	58.0	31.0

The graph hereafter presents the 4 indicators for the high EE and RE scenario, in graphic mode.

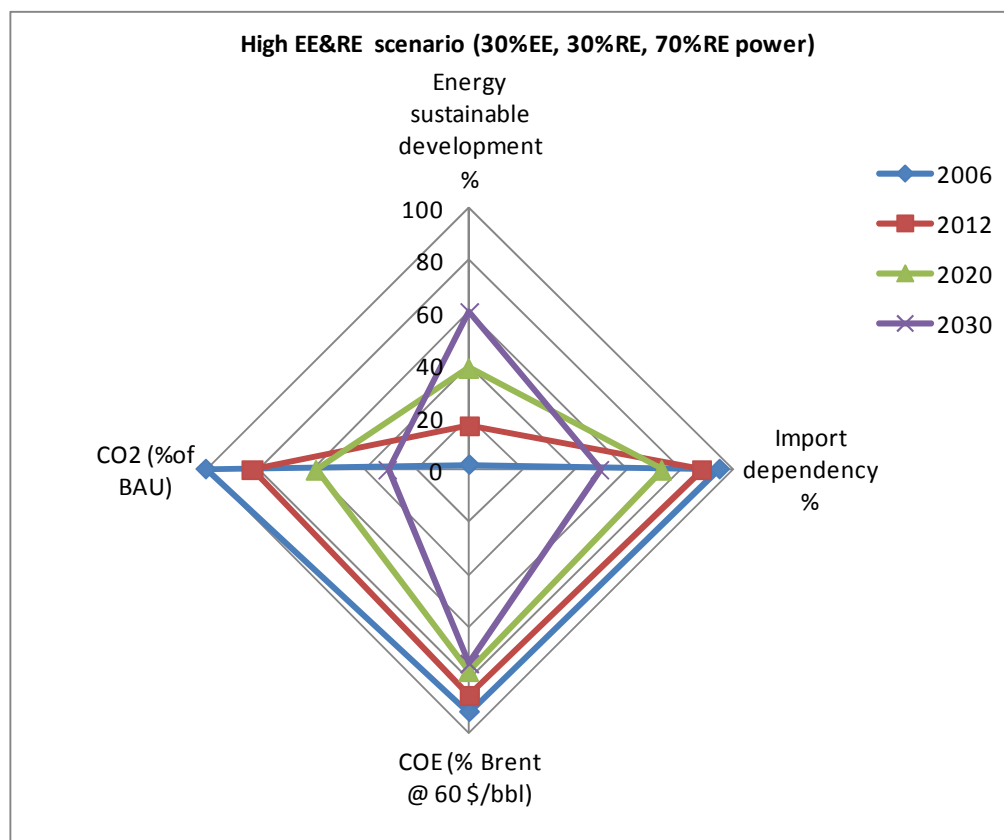

Source: Beicip-Franlab

**Figure 5-12 Evaluation of the high EE and RE scenario**

In this scenario, CO2 emissions are strongly reduced due to the high renewable energy penetration in the power production and due to the high energy efficiency development.

In comparison to the BAU, the high EE and RE scenario reduced the CO2 emissions mainly through 5 wedges which correspond to the introduction of wind power, solar energy, biomass (sustainable), nuclear and energy efficiency in the energy mix.

In addition to these 5 wedges, a sixth wedge represents the remaining potential for switching coal to gas.

The table hereafter gives the respective CO2 emissions abatement for each of those wedges. CO2 emissions in 2030 will be as low as in 2012.

**Table 25 High EE and RE scenario: CO2 abatement**

	1990	2000	2006	2012	2020	2030	CO2 abatement in 2030 compared to BAU			
	MtCO2/y	Mt/y	Mt/y	Mt/y	Mt/y	Mt/y	per wedge (Mt/y)	per wedge (%)	cumulated wedges (Mt/y)	cumulated wedges (%)
BAU	21.0	31.0	41.6	57.4	90.2	151.3	0.00	0%		
Wind			41.6	52.6	74.9	112.1	-39.18	-26%	-39.18	-26%
Solar			41.6	52.6	70.1	102.2	-9.97	-7%	-49.15	-32%
Biomass (sust)			41.6	52.6	70.1	100.8	-1.36	-1%	-50.51	-33%
Nuclear			41.6	52.6	70.1	93.6	-7.19	-5%	-57.70	-38%
EE			41.6	47.4	52.4	47.0	-46.63	-31%	-104.33	-69%
Coal to gas			41.6	47.4	50.3	47.0	0.00	0%	-104.33	-69%

The following abatement curve better illustrates these CO2 abatements.

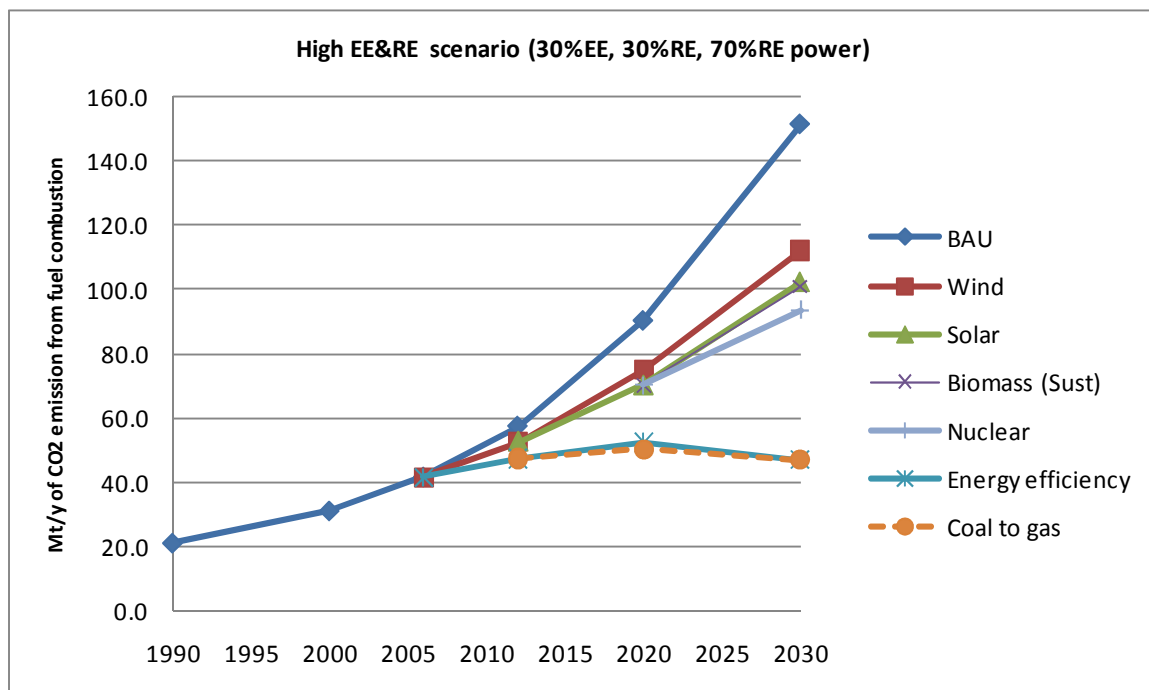

Source: Beicip-Franlab

**Figure 5-13 High EE and RE scenario: CO2 abatement curve**

The gas option has no more interest for abatement of CO<sub>2</sub> in power as old coal power plants are closed. In addition, modern coal power plants (that are kept) with very high efficiency are not running at their maximum capacity, and they are fed partially with biomass.

To get further decreased the remaining coal power plant should be replaced which is a costly solution. Also the nuclear option may be cancelled as enough coal power plants are available if some more PSP and RE are added.

The CO2 abatement cost curve gives the following result:

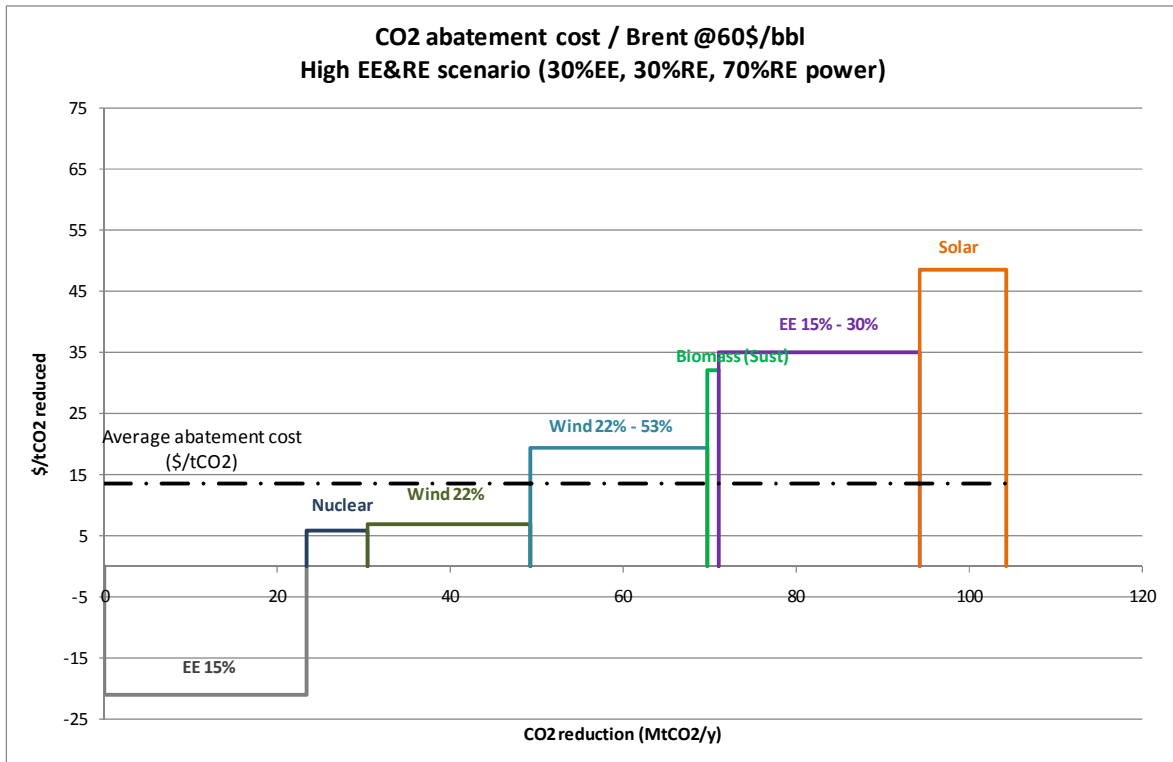

Source: Beicip-Franlab

**Figure 5-14 High EE and RE scenario: CO2 abatement cost**

EE, nuclear, low and high wind penetrations are the most efficient wedges to decrease CO2 emissions. The average abatement cost (dotted line in black) of this high EE&RE scenario is lower than 15\$/t of CO2 which is a low value compared to present CO2 market.

The following table gives the share of each energy and the related numerical results for TPES and COE.

**Table 26 Balance of the High EE and RE scenario**

	<b>2006</b>	<b>2012</b>	<b>2020</b>	<b>2030</b>
<b>EE</b>	0.0%	8.5%	18.8%	30.0%
<b>Hydro</b>	1.6%	1.2%	0.8%	0.5%
<b>Wind</b>	0.1%	6.8%	14.6%	22.9%
<b>Solar</b>	0.0%	0.0%	4.6%	5.8%
<b>Biomass (sust)</b>	0.0%	0.0%	0.0%	0.8%
<b>Nuclear</b>	0.0%	0.0%	0.0%	4.2%
<b>Gas</b>	3.7%	5.0%	3.4%	2.1%
<b>Oil &amp; petroleum prod.</b>	63.4%	51.7%	34.9%	27.1%
<b>Coal</b>	27.9%	24.3%	21.3%	5.6%
<b>Biomass (unsust.)</b>	3.4%	2.5%	1.7%	1.0%
<b>Total</b>	100.0%	100.0%	100.0%	100.0%
<b>Total RE without EE</b>	2%	8%	20%	30%
<b>TPES Mtoe/y</b>	13.4	16.4	21.6	30.3
<b>CO2 emission. Mt/y</b>	41.6	47.4	52.4	47.0
<b>COE G\$/y</b>	5.6	7.0	9.2	14.5
<b>EE Mtoe/y</b>	0.0	1.5	5.0	13.0
<b>Petroleum prod. Mtoe/y</b>	8.5	9.3	9.3	11.7
<b>Power TWh/h</b>	21	29	44	72
<b>Total RE with EE</b>	2%	9%	25%	43%
<b>Total RE in power prod</b>	4%	19%	47%	70%
<b>Total wind in power prod</b>	0%	16%	34%	53%

### 5.5 Comparison of the two low carbon energy scenarios

The high EE&RE scenario gives better results than Moroccan strategy for 3 criteria:

- the import dependency is reduced (50% vs. 70% for Moroccan strategy),
- the CO2 emissions are sharply decreased (69% of abatement vs. 37% for Moroccan strategy),
- and the energy sustainability is increased from 30% to 60% as per the definitions of the scenarios.

However, the COE for the high EE and RE scenario is higher by 6% in 2030 than for Morocco strategy.

A graphic comparison of these results is given hereafter.

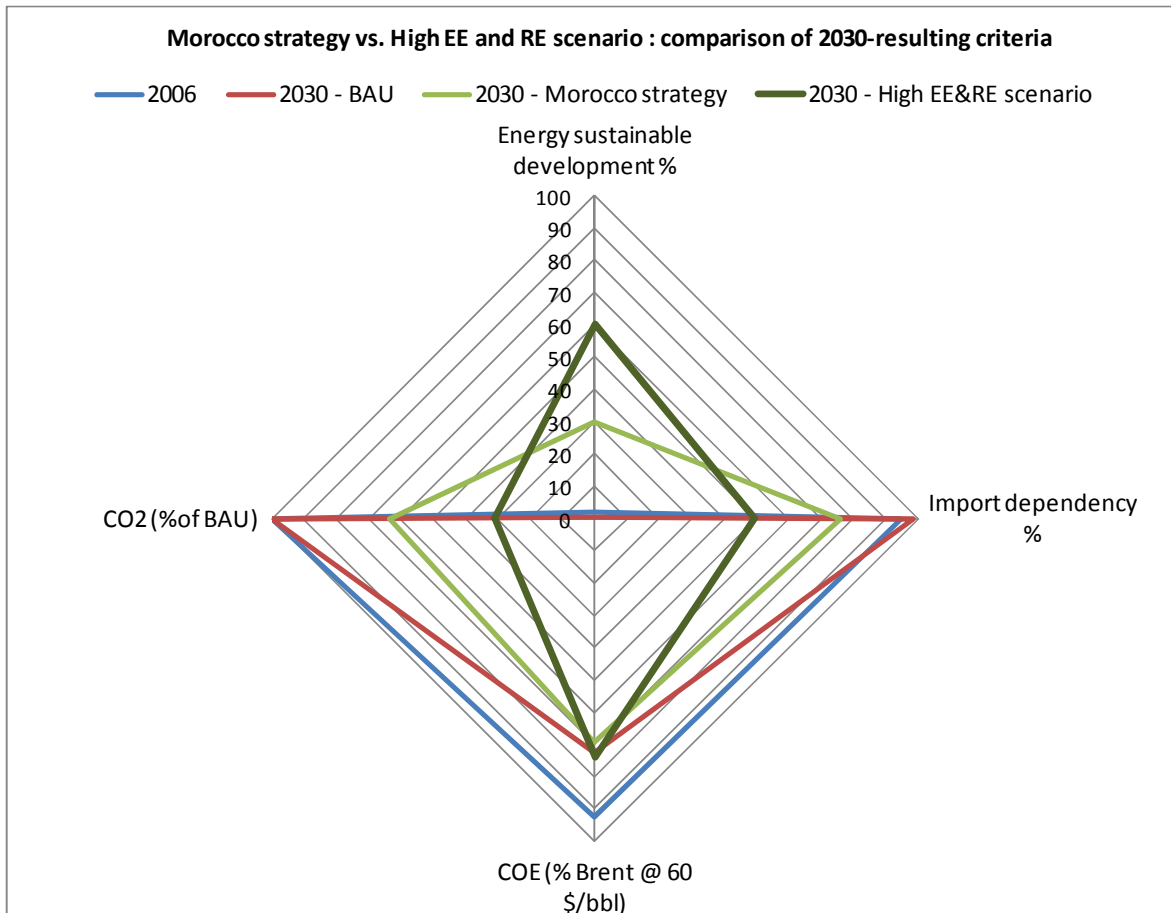

Source: Beicip-Franlab

**Figure 5-15 Comparison of Moroccan strategy with High EE&RE scenario**

In absolute values, the yearly net costs of the different scenarios are given in the following graph.

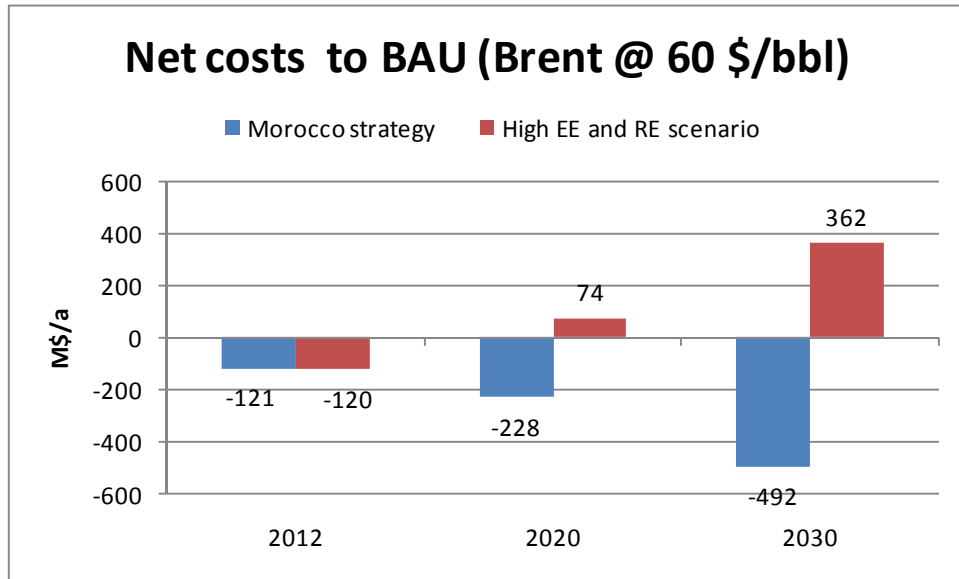

Figure 5-16 Net cost of low carbon energy scenarios compared to BAU (Brent@60\$/bbl)

For a Brent price at 60\$/bbl, overall Morocco energy strategy requires 492 M\$ less than the BAU scenario in 2030, when high EE and RE scenario requires 362 M\$ more.

The second level of Brent price considered (100 \$/bbl) shows that in a context of high energy price, Morocco strategy will provide important savings and High EE and RE scenario will become very attractive.

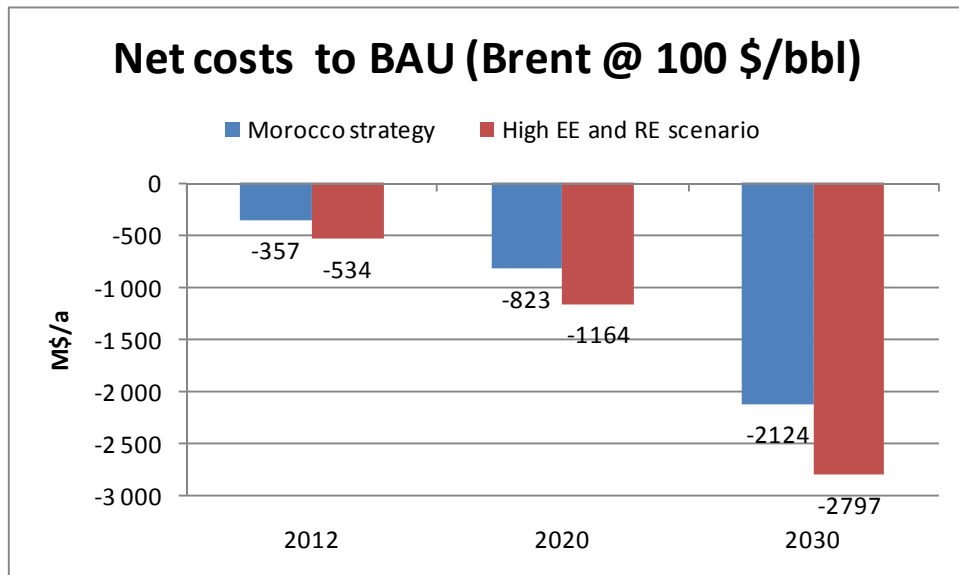

Figure 5-17 Net cost of low carbon energy scenarios compared to BAU (Brent@100\$/bbl)

## 5.6 Solar plan of November 2009

Moroccan authorities presented the 2<sup>nd</sup> November 2009 an ambitious solar plan for 2020. This plan is presented after issuance of the revision 1 of this report.

Five power plants will be installed with a total capacity of 2000MW. An estimated total installed cost of 9G\$ is announced by the authorities. These plants will produce 4.5 TWh/a by 2020.

**Table 27 Solar plan power plants**

Location	Power	Power Produced	Capacity Factor	Investment per kW	Investment	LCOE	CO2 abatement	Abatement cost
	MW	GWh/a	%	\$/kW	M\$	\$/MWh	MtCO2	\$/tCO2
Ouarzazate	500	1150	26%	4500	2250	193	1.12	152
Ain Beni Mathar	400	835	24%	4500	1800	209	0.81	169
Foum Al Oquad	500	1150	26%	4500	2250	193	1.12	152
Boujdour	100	230	26%	4500	450	193	0.22	152
Sabkhat Tah	500	1040	24%	4500	2250	209	1.01	169
<b>Total</b>	<b>2000</b>	<b>4405</b>	<b>25%</b>	<b>4500</b>	<b>9000</b>	<b>199</b>	<b>4.29</b>	<b>159</b>

The investments estimated by Moroccan authorities are higher than those considered in this report, given by IEA, therefore the resulting LCOE and CO2 abatement cost are also higher than those of table 16.

In 2020 this new plan will increase the share of renewable energy when compared to the Moroccan strategy evaluated in this report. The share of power produced by CSP will be around 10%, the share of RE in power will be around 28% as shown by the following table.

**Table 28 Renewable energy in 2020 with November 2009 solar plan**

	Installed power	Capacity factor	Produced power	Produced power share
	MW		TWh/a	
Wind	2200	37%	7.1	15.5%
Solar CSP	2000	25%	4.5	9.7%
Solar PV	200	21%	0.4	0.8%
Hydro (without PSP)	1200	8%	0.8	1.8%
Total RE for power	5600		12.8	27.8%
Total power network	14500		46	100.0%



## 6 RENEWABLE ENERGY EXPORT POTENTIAL TO EUROPE

### 6.1 Europe targets and present interconnection

Europe target is to reduce by 20% its energy consumption in 2020 compared to 2005, 20% its CO<sub>2</sub> emissions and bring 20% of renewable energy in its energy mix. One envisaged way to reach this target would be to import power produced from renewable energy.

A very ambitious program, lead by a consortium of German companies, is under development. It will source renewable energy (wind, solar) from North Africa (Morocco to Egypt) and even Arabian Gulf to Europe as shown below.

Budget of the program amounts, for the moment, 400 billion Euros.

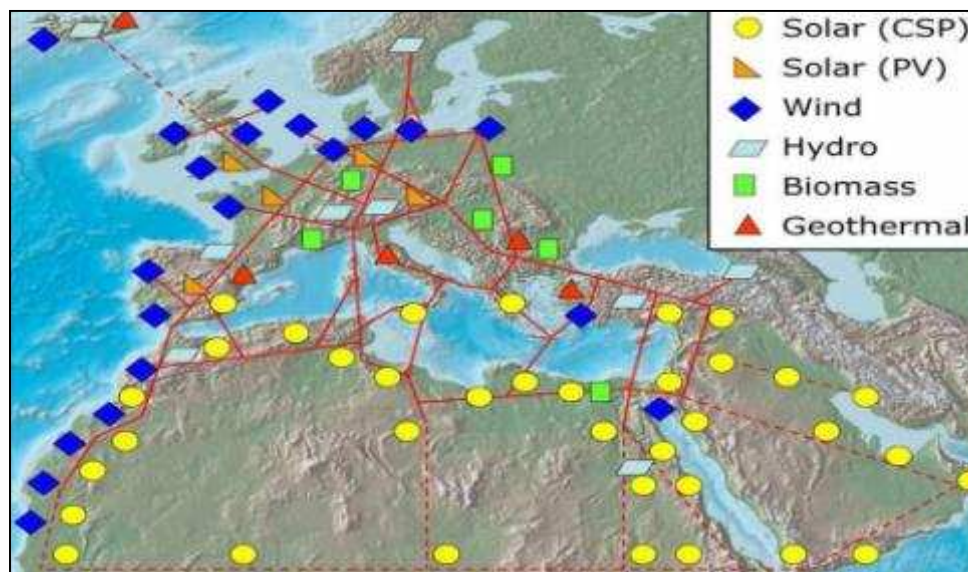

Source: DESERTEC

**Figure 6-1 Exporting renewable energy to Europe**

It is worth to note that European countries are well interconnected in order to create an efficient power exchanging network. For instance, since July 2009, a common organisation, ENTSOE as European network of transmission system operators for electricity, has been created. As illustrated on the following map, almost all European countries are connected.



Source: UCTE

**Figure 6-2 ENTSOE present interconnection (2008 figures in GWh)**

Morocco is linked to this network through Spain since 1998. Currently, the exchange capacity reaches 1400 MW (2 high voltage lines-700 MW) and a third line (of 700 MW too) is being planned by both countries.

These existing links place Morocco in a good position to become a partner of Europe and help it to achieve its 2020 targets.

## 6.2 Europe power sector present and future emissions

European Union has an average emission intensity of 354 gCO<sub>2</sub>/kWh which is half of the current one of Morocco. The situation varies depending on the energy mix: the emission intensity for France is 85 gCO<sub>2</sub>/kWh due to its nuclear power production while Germany with more coal power reaches 404 gCO<sub>2</sub>/kWh.

Spain which is today, and most likely tomorrow, the entry to Europe for Morocco has an emission intensity of 350 gCO<sub>2</sub>/kWh that is the average emission intensity for EU.

In 2020 Europe will see its power demand increasing; in this respect at least 30% of renewable energy will have to be added to the power energy mix to reach the target in CO<sub>2</sub> emissions. This means that average emission intensity should be around 250 gCO<sub>2</sub>/kWh.

With Moroccan strategy in 2020 the power emission intensity will not be reduced due to share of coal and in 2030 it will be around 600gCO<sub>2</sub>/kWh – still much more than Europe. Only the high EE&RE scenario allows Morocco to reach the level of Europe between 2020 and 2030.

The overall concept of importing green power from south Mediterranean to the north is that the gain on CO<sub>2</sub> emissions should be shared. It will be unfair to import green power from Morocco if at the same time Morocco increases its emission intensity as the remaining power will come from coal.

**Table 29 Europe power sector in comparison with Morocco**

	Annual power consumption	Emission intensity	Power emission	Total emission from fuel	Share of CO <sub>2</sub> power	Population	Emission per capita
	TWh	gCO <sub>2</sub> /kWh	MtCO <sub>2</sub>	MtCO <sub>2</sub>	% of TPES	Millions	tCO <sub>2</sub> /cap
<b>2006</b>							
Germany	854	404	345	821	42%	82	9.97
France	615	85	52	377	14%	63	5.96
United Kingdom	410	505	207	547	38%	59	9.28
Italy	365	404	147	450	33%	61	7.43
Spain	299	350	105	336	31%	44	7.61
Top 5	2543	337	856	2530	34%	309	8.18
Other EU27	1581	382	604	1492	40%	185	8.08
EU 27	4124	354	1460	4022	36%	494	8.14
Morocco	<b>22</b>	<b>759</b>	<b>16</b>	<b>40</b>	<b>41%</b>	<b>31.1</b>	<b>1.30</b>
EU 27 2020	<b>4537</b>	<b>248</b>	<b>1124</b>	<b>3218</b>	<b>35%</b>	<b>494</b>	<b>6.52</b>
Morocco strategy 2020	46	729	34	72	47%	37	1.95
Morocco strategy 2030	<b>81</b>	<b>583</b>	<b>47</b>	<b>96</b>	<b>49%</b>	<b>42</b>	<b>2.29</b>
Morocco high EE&RE 2020	44	523	23	52	44%	37	1.41
Morocco high EE&RE 2030	<b>72</b>	<b>137</b>	<b>10</b>	<b>47</b>	<b>21%</b>	<b>42</b>	<b>1.12</b>

The only strategy for Morocco to appear as a key partner to Europe in supplying green power is the high RE scenario described in section 5. Morocco can mix wind, solar and hydropower (PSP) to provide high quantity of RE to Europe but also at the lowest cost compared to the other African countries where only solar is available.

### 6.3 Spain current interconnections and exchange prices

Thanks to its modernization effort, Spain power sector has increased its exportations for the last 4 years as shown in the following graph.

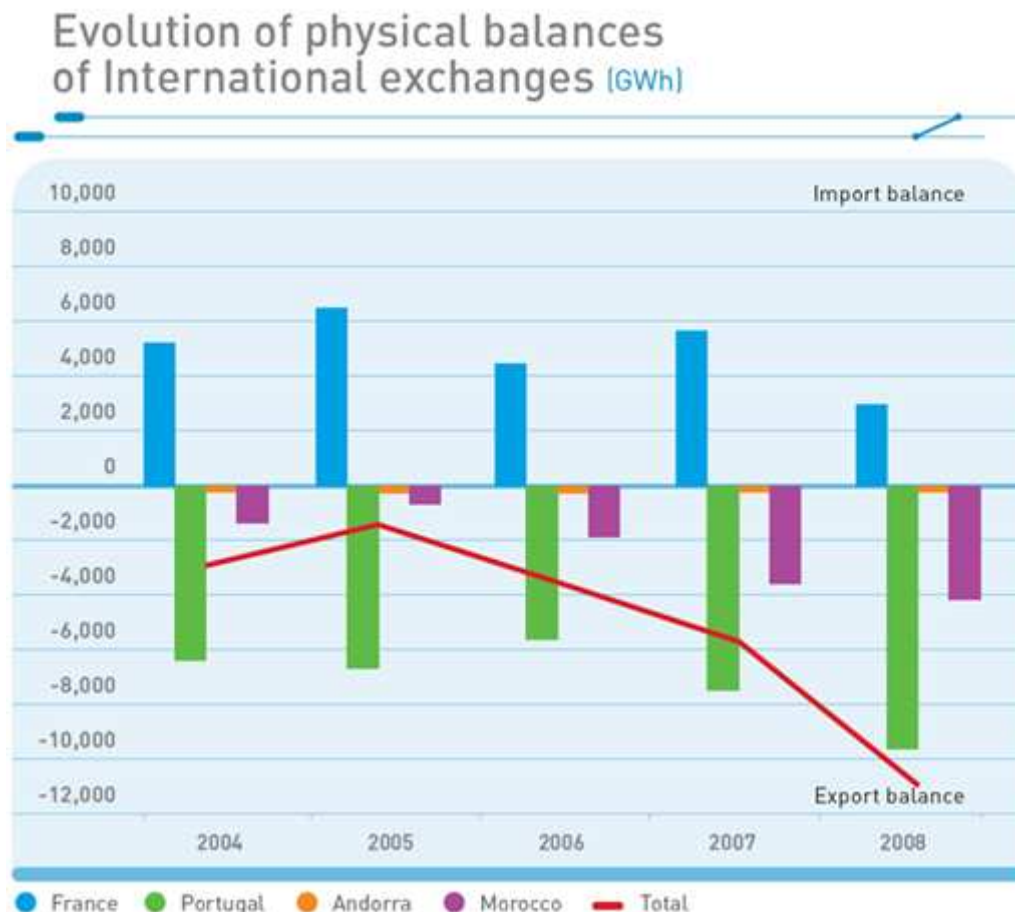

Source: RED ELECTRICA

Figure 6-3 Evolution of Spain power interconnections (2004-2008)

The remaining electricity imported to Spain comes from France which gives the marginal value of Spain and France excess power.

Table 30 Power exchange between France and Spain in 2008

	2008 power exchanged	2008 cost	Average cost	Average cost
Units	GWh	k€	€/MWh	\$/MWh
Import from France	4552	40405	8.9	11.7
Export to France	1662	51911	31.2	41.0

Source: RED ELECTRICA

These figures are very low, meaning that on an economical point of view, power price exported from Morocco should be between 11.7 to 41 \$/MWh. These values cannot be obtained from present Moroccan power system or future ones. Subsidies of at least 25\$/MWh through “green certificates” are requested if Morocco wants to invest to export green power from wind energy. For solar energy these subsidies will have to be around 100\$/MWh.

Spain is also investing deeply in renewable energy especially in wind energy but also in solar energy. Its ambitions are to provide green power to the rest of Europe; therefore Morocco may have to face a strong competitor for exporting power to Europe.

## 7 CONCLUSION

Emission of Moroccan energy sector can be viewed with two different eyes:

- Either we look at “emission per capita”: Morocco appears to be a dwarf. The emission per capita is low with a figure six times lower than Europe. Indeed Morocco is still a developing country where energy demand per capita is quite low.
- Or we look at “emission intensity” of power sector: Moroccan power sector emits more than one third of total CO<sub>2</sub> emissions of Morocco. In addition, the power emission intensity (gCO<sub>2</sub>/kWh) is quite high: two times more than Europe.

Morocco is under no obligation to Kyoto Protocol of emission reduction and Morocco's main challenge is to meet the growing need of energy of its population and industry at the most economic condition taking into account its independence.

In this respect a strategy (said to be “ambitious and realistic”) is proposed by Moroccan authorities to meet energy demand in 2020 and 2030. Until 2020 focus is on meeting the demand with an increased consumption of coal, then after, while meeting the expected demand, effort is put on decrease of import dependency. This is done through energy efficiency (effect on demand) and growing introduction of local green energy (effect on supply) such as wind energy. It has an immediate effect on the emission intensity of power sector which is decreased by 25%.

It is interesting noting that the 4 criteria defined by Beicip-Franlab to assess the strategy evolve in the right direction: Import dependency, cost of energy, and emission of CO<sub>2</sub> (versus a BAU scenario) decrease while energy sustainable development increases.

A “Plan National d'Actions Prioritaires” (PNAP) is presented by Moroccan Authorities. It is supposed to materialize the strategy until 2015. As far as introduction of green energy is concerned, the PNAP is in line with the Moroccan strategy. Energy efficiency is not quantified enough to be assessed.

Indeed the potential for wind energy appears quite underestimated. We believe that 11 GW of wind capacity could be easily installed by 2030 instead of only 6 GW envisaged by CDER. These wind farms should be coupled with pumping storage plants (PSP) to increase their flexibility and reliability. Several existing dams could receive these PSP. While meeting the energy demand this scenario will further improve the criteria defined by Beicip-Franlab.

Thanks to this scenario, the emission intensity of power sector will dramatically decrease to a lower level than Europe.

With an electricity greener than European electricity, Morocco may be in a good position to be a green power provider for Europe. However, this green power will need to be subsidized to go through the two very competitive power markets that are Spain and France.

In November 2009 after the present report is finalized, Moroccan authorities presented a solar power plan which increases the renewable energy target in 2020, making solar energy target comparable to the wind energy target.

Investing in wind and solar energy in parallel is a very costly and challenging decision. This is also a strategic choice which will allow Morocco to fully valorise its natural resources and make it more energy-independent.

## REFERENCES

1. **World Energy Outlook**, 2008, International Energy Agency (IEA)
2. **CO2 emissions from fuel combustion**, 2008, International Energy Agency (IEA)
3. **Construction cost, operating costs and efficiencies of power plants**, 2008, IEA
4. **BP statistical review of world energy**, June 2009, British Petroleum (BP)
5. **Statistical review of global LP gas**, 2008, World LP Gas Association
6. **LP gas : efficient energy for a modern world**, January 2009, World LP gas Association
7. **Stabilization wedges : solving the climate problem for the next half-century with technologies available today**, November 2004, Robert Socolow, Princeton University
8. **Pathways to a low-carbon economy**, version 2 of the Global greenhouse gas abatement cost curve, 2009, McKinsey & Company
9. **Rapport de l'inventaire national des émissions des gaz à effet de serre**, November 2008, Ministère de l'énergie, des mines, de l'eau et de l'environnement – Kingdom of Morocco
10. **Programme National d'Actions Prioritaires (PNAP) – Etat d'avancement**, February 2009, Mrs. Amina Benkhadra, Minister of energy, Mines, water and environment, Kingdom of Morocco
11. **Stratégie énergétique nationale – enjeux et perspectives**, February 2009, Ministry of energy, mines, water and environment, Kingdom of Morocco
12. **Secteur de l'énergie – chiffres clés 2008**, February 2009, Ministry of energy, mines, water and environment, Kingdom of Morocco
13. **1ères Assises de l'énergie – L'accès généralisé à l'électricité, un préalable au développement**, 6 Mars 2009, Ali Fassi Fihri, Directeur général de l'Office National de l'Electricité (ONE)
14. **1ères Assises de l'énergie – Les énergies renouvelables : des énergies propres pour un développement durable**, 6 Mars 2009, Amal Haddouche, Directeur général du CDER.
15. **1ères Assises de l'énergie – Ancrer l'efficacité énergétique dans la société**, 6 Mars 2009, Said Mouline, Conseiller OCP, Président de l'AMISOLE.
16. **Etude du marché du gaz butane "cible des ménages"**, Septembre 2005, Groupement des Pétroliers du Maroc (GPM)
17. **World wind energy report 2008**, February 2009, World Wind Energy Association (WWEA)

18. **Wikipedia, the free encyclopedia : wind power**, August 2009, [http://en.wikipedia.org/wiki/Wind\\_power](http://en.wikipedia.org/wiki/Wind_power)
19. **Wikipedia, the free encyclopedia : wind power**, August 2009, [http://en.wikipedia.org/wiki/Solar\\_thermal\\_energy](http://en.wikipedia.org/wiki/Solar_thermal_energy)
20. **Wikipedia, the free encyclopedia : pumped storage hydroelectricity**, August 2009, [http://en.wikipedia.org/wiki/Pumped-storage\\_hydroelectricity](http://en.wikipedia.org/wiki/Pumped-storage_hydroelectricity)
21. **Sahara wind energy development project**, August 2009, <http://www.saharawind.com/index.php?lang=en>
22. **Danish Wind Industry Association**, July 2009, <http://www.windpower.org/en>
23. **IPCC – National greenhouse gas inventories program**, 2006, <http://www.ipcc-nggip.iges.or.jp/public/2006gl/vol2.html>
24. **World Economic Outlook database 2009, April 2009**, International Monetary Fund, <http://www.imf.org/external/pubs/ft/weo/2009/01/weodata/index.aspx>
25. **Centre de développement des énergies renouvelables (CDER)**, July 2009, <http://www.cder.org.ma/>
26. **Office National de l'Electricité (ONE)**, August 2009, <http://www.one.org.ma>
27. **Kingdom of Morocco, Ministry of energy mines water and environment**, July 2009, <http://www.mem.gov.ma/>
28. **Barrages du Maroc**, Juillet 2009, Secrétariat d'Etat chargé de l'eau, <http://www.water.gov.ma/>
29. **Système d'information sur l'énergie durable et les changements climatique (SIEDCC)**, Juillet 2009, CDER, <http://www.ciede.org.ma/siedcc/siedcc/Default.html>
30. **Système d'aide à la décision agricole (SAADA)**, August 2009, <http://aridoculture.googlepages.com/home>